



CAPACITIVE LEVEL METERS CLM-36



CONTENTS

2. Basic description	4
1. Range of application	4
3. Variants of sensors	5
4. Dimensional drawing.....	6
5. Influence of the tank shape on a linearity of measurement.....	8
6. Installation and putting into operation	9
7. Mechanical mounting	9
8. Electrical connection	12
9. Preparing of level meter for measuring	14
10. Settings	15
11. Order code	17
12. Correct specification examples	17
13. Accessories.....	17
14. Safety, protections, compatibility and explosion proof	18
15. Use, manipulation and maintenance.....	19
16. General, conditions and warranty	20
17. Marking of labels	21
18. Technical specifications.....	23
19. Table of relative permittivity	27
20. Packaging, shipping and storage	28

USED SYMBOLS

To ensure maximum safety of control processes, we have defined the following safety instructions and information. Each instruction is labelled with the appropriate pictogram.



Alert, warning, danger

This symbol informs you about particularly important instructions for installation and operation of equipment or dangerous situations that may occur during the installation and operation. Not observing these instructions may cause disturbance, damage or destruction of equipment or may cause injury.



Information

This symbol indicates particularly important characteristics of the device.



Note

This symbol indicates helpful additional information.

SAFETY



All operations described in this instruction manual have to be carried out by trained personnel or by an accredited person only. Warranty and post warranty service must be exclusively carried out by the manufacturer.

Improper use, installation or set-up of the sensor can lead to crashes in the application.

The manufacturer is not responsible for improper use, loss of work caused by either direct or indirect damage, and for expenses incurred at the time of installation or during the period of use of the level sensors.

2. BASIC DESCRIPTION

Capacitive level meters CLM® are designed for continuous level measurement of liquids, powders and bulk-solid materials in vessels, tanks, sumps, containers, silos, etc. CLM consists of the stainless steel housing with electronic module and the measuring electrode. The electronic part converts the capacity into the current signal (4 ... 20 mA) or voltage signal (0 ... 10 V). Sensitivity (SPAN) and initial capacity compensation (ZERO) can be fluently set.

Level meters are produced in the following performances: **N** – for non-explosive areas, **NT** – high temperature for non-explosive areas, **Xi** – Explosion proof – intrinsically safe for hazardous (explosive) areas and **XiT** - high-temperature conf. for explosive environments. CLM are offered in variants with various types of process connection (thread, Tri-clamp).

1. RANGE OF APPLICATION

Capacitive level meters are suitable for continuous level measurement of liquid and bulk-solid materials. CLMs are resistant to any changes in the atmosphere above the surface (vacuum, pressure, vapours, dust).

3. VARIANTS OF SENSORS

- **CLM-36_-10 With uncoated rod electrode** for level measurement of non-conductive liquids (oils, diesel, petrol) and powder or bulk-solid materials (flour, sand, cement, plastic granulates, etc.).
Electrode length from 0.2 m to 5 m (for materials with a low permittivity $\epsilon_r < 10$, the minimum electrode length is 0.5m).
- **CLM-36_-11 With fully (PFA) coated rod electrode** suitable for surface level measurement of water and other electrically conductive liquids. Also suitable for polluted liquids in metallic storage tanks, concrete sumps, etc.
Electrode length from 0.2 m to 3 m.
- **CLM-36_-12 With fully (FEP) coated rod electrode** suitable for surface level measurement of water and other electrically conductive liquids. Also suitable for polluted liquids in metallic storage tanks, concrete sumps, etc.
Electrode length from 0.2 m to 3 m.
- **CLM-36_-20 With uncoated rod electrode and reference tube** for accurate level measurement of clean non-conductive liquids (oils, diesel, petrol).
Electrode length from 0.2 m to 3 m.
- **CLM-36_-22 With fully FEP coated rod electrode and reference tube** for surface level measurement of electrically conductive liquids, (e.g. in plastic or glass storage tanks) and where greater measurement accuracy is required. Electrode insulation from FEP material.
Electrode length from 0.2 m to 3 m.
- **CLM-36_-30 With uncoated stainless steel rope electrode and uncoated weight** for level measurement of bulk-solid materials (grains, sand, flour, cement, etc.)
Shortened cable option.
Electrode length from 1 m to 20 m.
- **CLM-36_-31 With uncoated stainless steel rope electrode and coated dynamic anchorage** for level measurement of bulk-solid materials in higher silos.
Electrode length from 1 m to 20 m.
- **CLM-36_-32 With fully coated rope electrode and coated weight** (rope insulation FEP, weight insulation PTFE), for level measurement of electrically conductive and non-conductive liquids.
Electrode length from 1 m to 20 m.

4. DIMENSIONAL DRAWING

CLM-36_-10, 11, 12

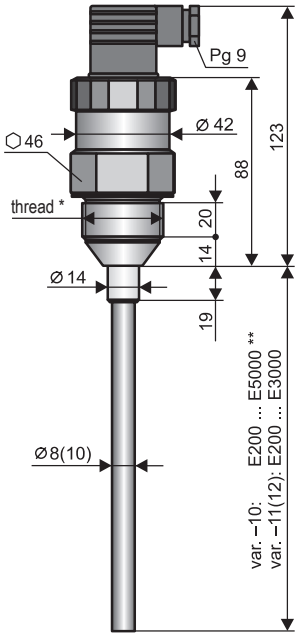

CLM-36_-20, 22

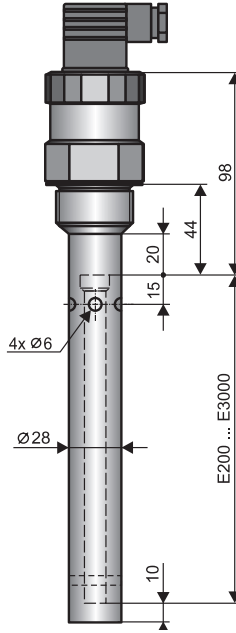

CLM-36_-30

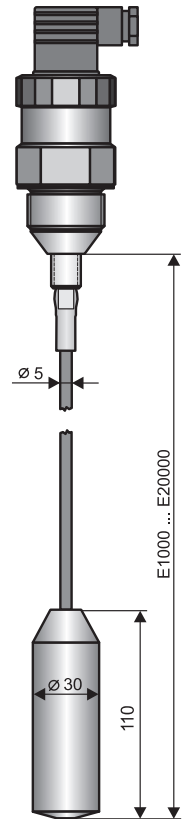

* type threads: M36x2; G1"

** for materials with a low permittivity ($\epsilon_r < 10$) the minimum electrode length is E500.

High temperature variants
CLM-36_T

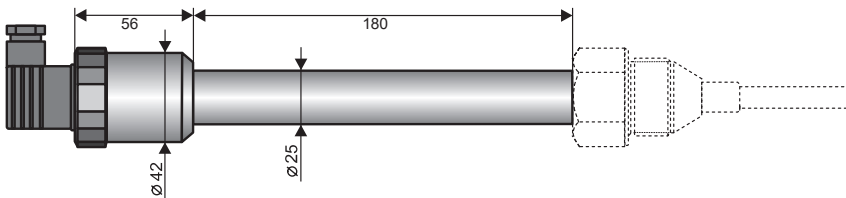

CLM-36_32

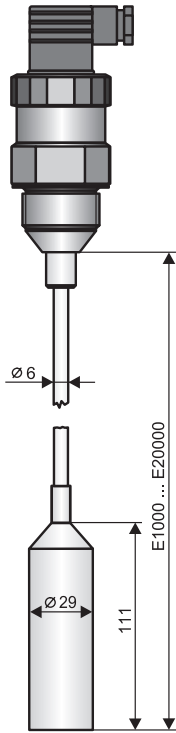

CLM-36_31

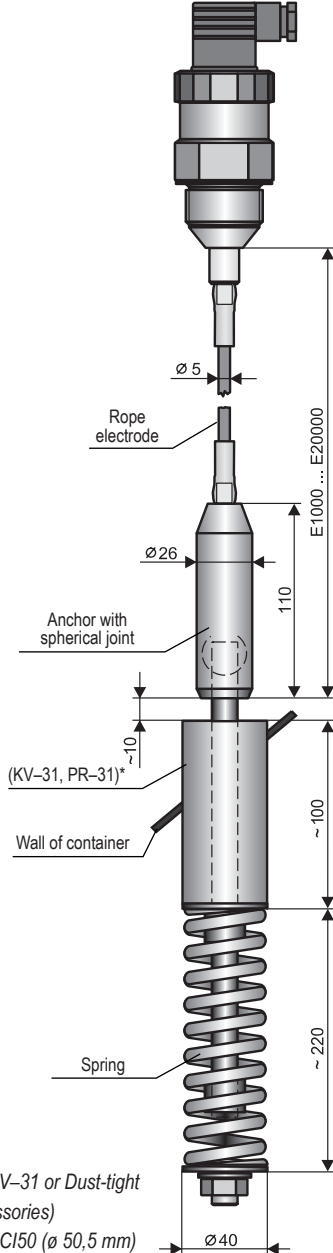

Housing with Tri-clamp coupling

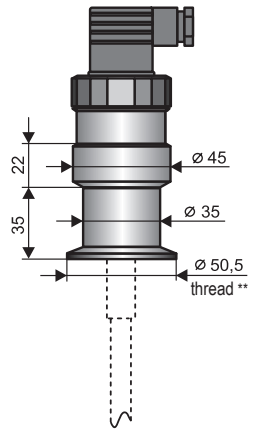

* Anchor welding cylinder KV-31 or Dust-tight bushing PR-31 (see accessories)

** type of threads: Tri-Clamp CI50 ($\varnothing 50,5$ mm)

5. INFLUENCE OF THE TANK SHAPE ON A LINEARITY OF MEASUREMENT

- In a curved tanks (most frequently horizontal cylinder) capacity change during measuring of electrically non-conductive material is non-linear.

**FOR TYPE: CLM-36_-10, 11, 12
CLM-36_-30, 31, 32**

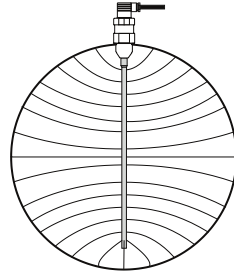

- Linearity is done by reference tube (CLM – 36_-20, 22).

FOR TYPE: CLM-36_-20, 22

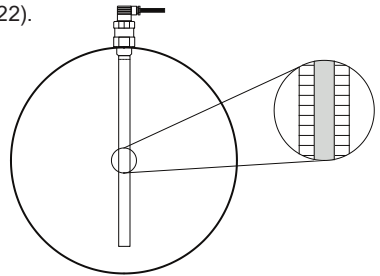

- In the tank with straight wall (for example vertical cylinder) and with the sensor placed parallelly with the wall capacity change is linear.

FOR TYPE: All variants

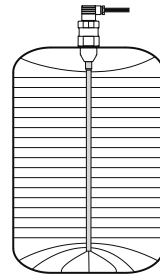

6. INSTALLATION AND PUTTING INTO OPERATION

Please follow next 3 steps:

- **MECHANICAL MOUNTING - SEE CHAPTER 7**
- **ELECTRICAL CONNECTION - SEE CHAPTER 8**
- **SETTINGS - SEE CHAPTER 10**

7. MECHANICAL MOUNTING

BASIC INFORMATION

- Level meters with coated electrode have protection cover at the end of electrode, which is necessary take down before mounting.
- Level meters mount in vertical position to upper lid of tank or reservoir by steel welding flange ON-36x2 (steel 11375), stainless steel welding flange NN-36x2 (stainless steel 1.4301), fixing nut UM-36x2 (stainless steel 1.4301) or Clamp flange.
- For mounting level meter to the metal tank or reservoir is not necessary to ground housing again.
- In case of installation in concrete sumps or silos it is properly to install level meter at metallic auxiliary construction (console, lid, etc.) and then connect with metal all the time submerged object, eventually with steel armouring.
- For measuring of material in plastic and glass vessels by level meter without reference tube is necessary to connect grounding screw at housing with auxiliary electrode which is fixed by the appropriate method to the outer casing of vessels (or at inner wall). Material of auxiliary electrode is necessary to choose with consideration to the working environment and properties of measured material.

METAL AND NON-METAL VESSELS

FOR TYPE: CLM-36_-10, 11, 12

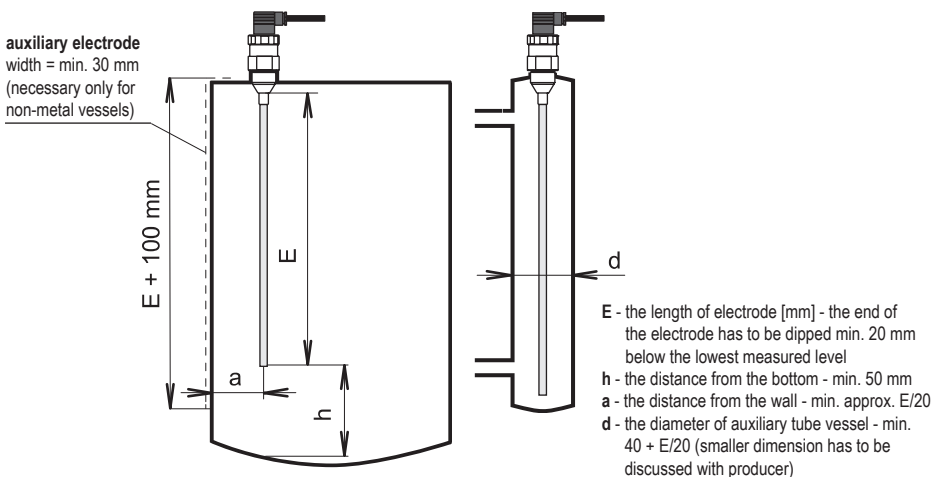
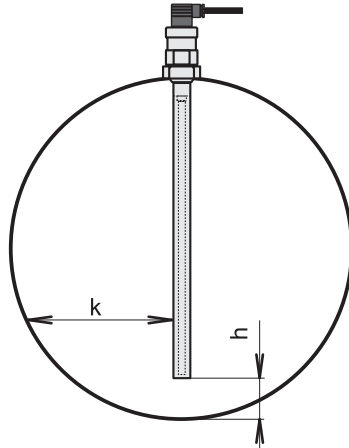
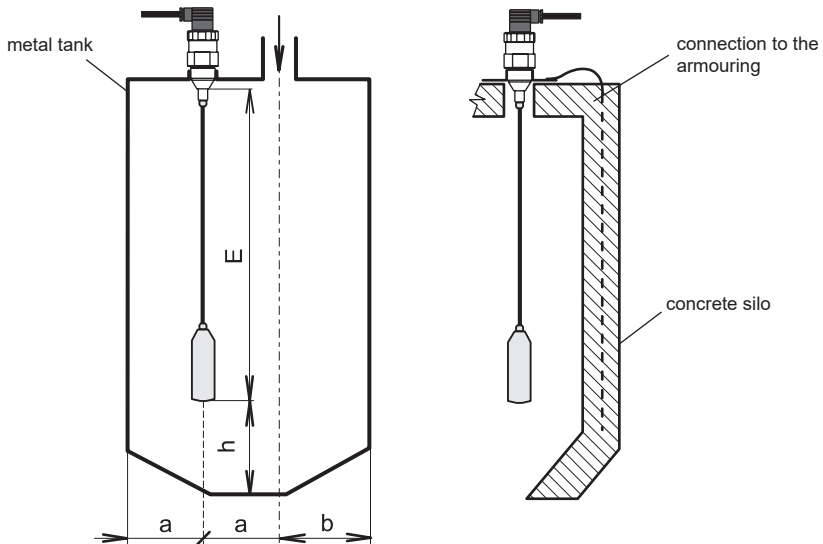

Fig. 1: Installation of level meter with rod electrode



h - the distance from the bottom
- min. 50 mm with respect on
possibility of presence of heavy
fraction (water) in oil products
k - the distance from the wall -
optional

Fig. 2: Installation of level meter with reference tube



E - The length of electrode - the lower end of the electrode has to be dipped - min. 20 mm below the lowest measured level
h - The distance from the bottom - min. 100 mm
a - The distance from the wall - at least $E/20$, as far as possible from the walls, to the middle between the wall and the vertical inlet

Fig. 3: Installation of level meter with rope electrode

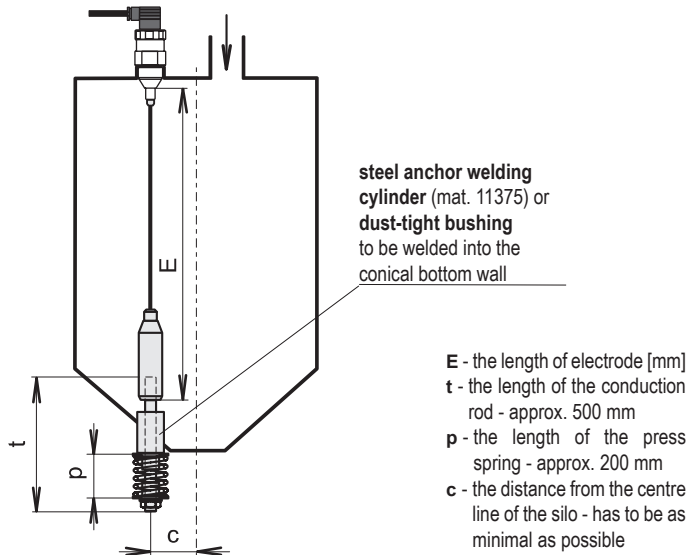

Fig. 4: Installation of rope electrode with anchor

8. ELECTRICAL CONNECTION

The level meter is designed to be connected to supply unit or to controller through a cable with the outer diameter of 6 ± 8 mm (recommended cross-section of cores 0.5 ± 0.75 mm²) by means of connector which is standard part of CLM level meter. The diagram and the inside view of the connector are shown in the figures. Disassemblable connector IP67 with a 5m long PVC cable can be supplied as an above-standard accessory.

Procedure to connect the cable to the level meter:

1. Unscrew connector from the body of the level meter using a suitable screwdriver.
2. Use a flat screwdriver to remove the inner part of the connector (screwdriver into the gap marked by arrow).
3. Unscrew the cable gland and put the cable inside.
4. Connect the cable wires to the screw terminals as shown in Fig. 7 (current output 4-20 mA) or Fig. 9 (voltage output 0-10 V). Tighten the terminals firmly.
5. Push the terminals back into the connector so that the terminal no. 3 is oriented toward the cable entry. Tighten the cable gland.
6. Check the seal on the connector and connect the connector back to the body of the sensor.

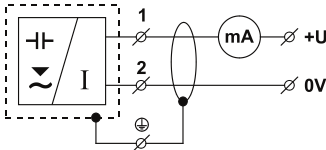

Fig. 6: Connection scheme with current output

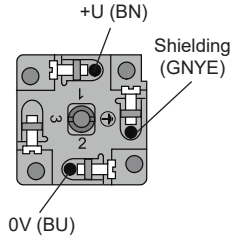

Fig. 7: Connection scheme with current output

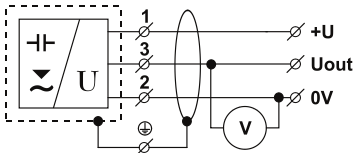

Fig. 8: Connection scheme with voltage output

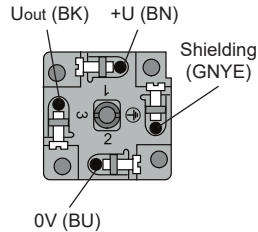

Fig. 9: Connection scheme with voltage output



Electrical connection can only be made when de-energized!

The source of the power voltage must comprise of a stabilised safe low power source with galvanic separation. In the event that a switch-mode power supply is used, it is essential that its construction effectively suppresses common mode interference on the secondary side. In the event that the switch-mode power supply is equipped with a PE safety terminal, it must be unconditionally grounded! Spark-safe devices type CLM-36Xi(XiT) must be powered from a spark-safe power source meeting the above-mentioned requirements.



Due to the possible occurrence of an electrostatic charge on the non-conductive parts of the sensor, it is necessary to ground all sensors intended for use in environments with an explosion hazard type CLM-36Xi(XiT). This can be performed by grounding el. conductive tanks or el. conductive tank lids, and in the case of el. non-conductive tanks using and grounding an auxiliary plate electrode PDE-27.

In the event that sensor is installed in an outdoor environment at a distance greater than 20 m from the outdoor switchboard, or from an enclosed building, it is necessary to supplement the electrical cable leading to sensor with suitable over voltage protection.

In the event of strong ambient electromagnetic interference, paralleling of conductors with power distribution, or for distribution to distances over 30 m, we recommend using a shielded cable and grounding the shielding on the side of the power source.

9. PREPARING OF LEVEL METER FOR MEASURING

PREPARING OF LEVEL METER

1. For access to the adjustment elements disconnect a connector and unscrew a nut (attention for inside connecting wires). Connect the connector again.
2. Connect the level meter to the supply unit through milliammeter (controller, etc.).
3. Set the trimmer^{*1)} 20 mA into the basic position (this position is set by producer):
 - a) Turn the trimmer totally right (clockwise).
 - b) Turn the trimmer back about 3 turns left (anti clockwise).

ADJUSTMENT ELEMENTS OF LEVEL METER

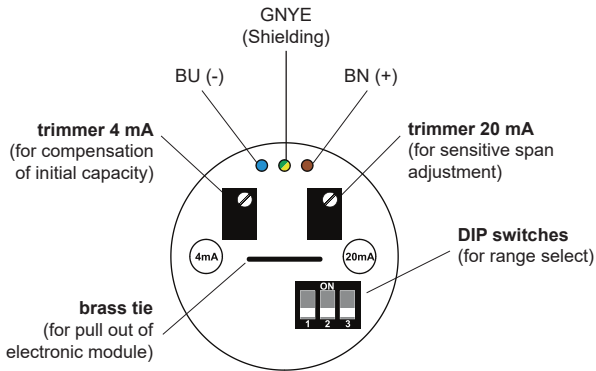

Fig. 10: The top view on the internal electronic module with current output (variant –I)

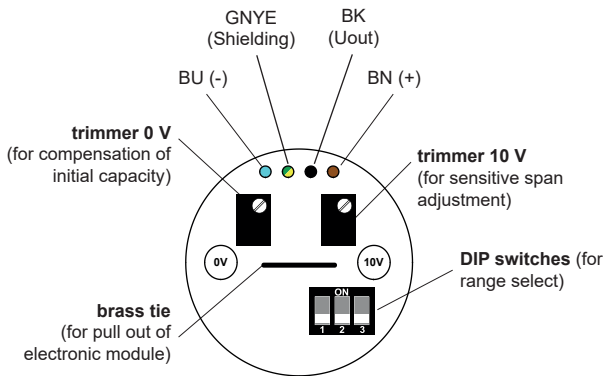

Fig. 11: The top view on the internal electronic module with voltage output (variant –U)

Legend:

GNYE – green-yellow
BU – blue
BK – black
BN – brown

*1) The trimmers are without backstops - approx. 15 turns

10. SETTINGS

CURRENT OUTPUT 4 ... 20 mA

1. Empty the tank to the minimum level.
2. Set the DIP switches on the CLM to range³⁾ No. 2 (250 pF).
3. By a screwdriver turn the **trimmer 4 mA** and set the quiescent current of the level meter to 4 mA. Turning rightwards (clockwise) increases the current, turning leftwards decreases the current. When it is impossible to set required current to 4 mA, then switch DIP switches to the nearest higher range and set up the current 4 mA at that range.
4. Fill the tank to the maximum level. When it is impossible fill the tank to the maximum known (or checkable) level. For the next settings calculate the output current using the next formula:

$$I_{\text{out}} = 4 + (0,16 \times \text{level in \%}) \quad [\text{mA}]$$

5. If the output current is less than 20 mA (or the calculated value of I out), set the DIP switch to the lowest range No. 1. and continue to step 7. When the output current exceeds 20 mA, continue on step 6.
6. Set the DIP switches step by step to higher ranges till the current is greater then 20 mA (or calculated value of I out), then the current e.g. 21 mA⁴⁾ flows through the level meter. **Trimmer 20 mA** is still in basic position.
7. Then set the current of CLM by **trimmer 20 mA** onto 20 mA (or to the calculated value of I out - see above).
8. To reach a maximum accuracy is useful to check the setting of 4 mA again (compensation of initial capacity - quiescent current).









VOLTAGE OUTPUT 0 ... 10 V

1. Empty tank to the minimum level.
2. By DIP switches on level meter set range³⁾ No. 2 (250 pF).
3. Use a screwdriver to turn the **trimmer to 0 V** and set the voltage at the output from the level meter to 0 V. Turning rightwards (clockwise) increases the voltage, turning leftwards decreases the voltage. When it is impossible to set required voltage to 0 V, then switch DIP switches to the nearest higher range and set up the voltage 0 V at that range.
4. Fill the tank to the maximum level. When it is impossible fill the tank to the maximum known (or checkable) level. For the next settings calculate the output voltage using the next formula:

$$U_{\text{out}} = 0,1 \times \text{level in \%} \quad [\text{V}]$$

5. If the output voltage is less than 10 V (or the calculated value of U out), set the DIP switch to the lowest range No. 1. and continue to step 7. When the output voltage exceeds 10 V, continue on step 6.
6. Set the DIP switches step by step to higher ranges till the voltage is greater then 10 V (or calculated value of U out), then the voltage e.g. 10,5 V flows through the level meter. **Trimmer 10 V** is still in basic position.

7. Then set the voltage of CLM by **trimmer 10 V** onto 10 V (or to the calculated value of U out - see above).
8. To reach a maximum accuracy is useful to check the setting of 0 V again.

Table of ranges			
No.	Sensitivity ²⁾ (C)	Range ³⁾ (R)	Position of DIP switch
1 ¹⁾	20 pF	70 pF	
2	30 pF	250 pF	
3	50 pF	600 pF	
4	100 pF	1 200 pF	
5	150 pF	3 000 pF	
6	300 pF	7 000 pF	
7	500 pF	18 000 pF	
8	1 000 pF	36 000 pF	

Tables of recommended ranges depending on the medium and the type of level meter						
Medium	Sand, grains		Cement		Flour	
	1 m	5 m	1 m	5 m	1 m	5 m
Typ						
10	2	3	2	4	1	3
12	2	3	2	4	1	3
30	2	3	2	4	1	3
31	2	3	2	4	1	3
Medium	Water		Benzene, petroleum, diesel, oil			
Typ	1 m	2 m	1 m		2 m	
10	-	-	1		2	
12	3	4	1		2	
20	-	-	2		3	
22	3	4	2		3	
32	3	4	1		2	

Note.: Types 10, 12, 30, 31, 32 in distance 250 mm from conducting wall.
 Shownd ranges are orientation. Exact range for existing configuration electrode / tank must be set directly in application on mearured medium.

*1) Range No. 1 (70 pF) is very sensitive and we recommend to use it only at level meters with short electrode (approx. to 500 mm) and measured media with low permittivity

*2) Sensitivity - minimal capacity change of electrode to reach output range $4 \div 20$ mA or $0 \div 10$ V.

*3) Range = capacity of housing + activated electrode to reach output range $4 \div 20$ mA or $0 \div 10$ V. (For example.: uncoated electrode 1000 mm immersion in fuel: 20 pF + 30 pF, coated electrode 1000 mm immersion in water: 20 pF + 500 pF)

*4) In case of short of electrode on housing or setting of a very sensitive range can caused to current restriction of level meter on value max. 30 mA.

11. ORDER CODE

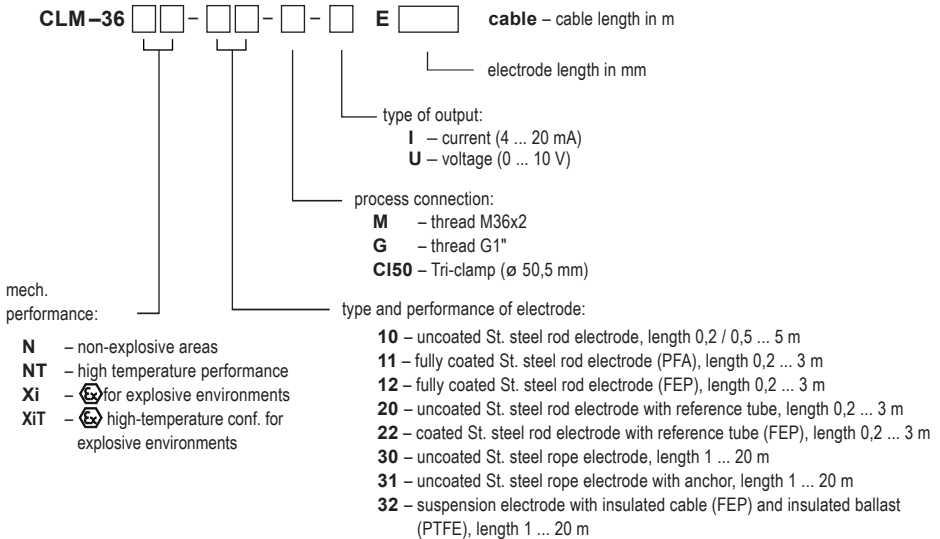

12. CORRECT SPECIFICATION EXAMPLES

CLM-36N-10-G-I E1000

(**N**) normal (for non-explosive areas); (**10**) uncoated St. steel rod electrode; (**G**) process connection thread G1"; (**I**) current (4 ... 20 mA); (**E1000**) length electrode 1000 mm

CLM-36XiT-30-G-I E9750

(**XiT**) high-temperature conf. for explosive environments; (**30**) uncoated St. steel rope electrode; (**G**) process connection thread G1"; (**I**) current (4 ... 20 mA); (**E9750**) length electrode 9750 mm.

13. ACCESSORIES

standard (included in the level meter price)

- 1x of seal, other seals are on request (PTFE, Al, etc.) *
- 1x connector socket
- 1x screwdriver for adjustment (each 5 pcs)

* Pressure resistance - see the table in the accessories datasheet in the "seals and gaskets".

optional – for a surcharge (see catalogue sheet of accessories)

- Connector with protection class IP67 (GAN-DADE 7A) with 5 m cable (current output)
- Connector with protection class IP67 (GAN-DAAE 7A) with 5 m cable (voltage output)
- Steel welding flange ON-36x2
- St. steel welding flange NN-36x2
- St. steel fixing nut UM-36x2
- Anchor welding cylinder KV-31 (only CLM-36-31)
- Dust-tight bushing PR-31 (only CLM-36-31)

14. SAFETY, PROTECTIONS, COMPATIBILITY AND EXPLOSION PROOF

Level meter is equipped with protection against electric shock on the electrode, reverse polarity, output current overload, short circuit and against current overload on output.

Protection against dangerous contact is provided by low safety voltage according to 33 2000-4-41. Electromagnetic compatibility is provided by conformity with standards EN 55022 / B, EN 61326-1, EN 61000-4-2 to -6.

Explosion proof CLM-36Xi(XiT) is provided by conformity with standards EN 60079-0:2013+A11:2014, EN 60079-11:2012.

Explosion proof CLM-36Xi(XiT) is verified FTZÚ – AO 210 Ostrava – Radvanice: FTZÚ 02 ATEX 0235X.

A declaration of conformity was issued for this device in the wording of Act No. 90/2016 Coll., as amended. Supplied electrical equipment matches the requirements of valid European directives for safety and electromagnetic compatibility.

Special conditions for safe use of variants CLM-36Xi

If the apparatus is used as device of Group II and with using of an approved power supply device, which output parameters comply with required input parameters, it is necessary to have an galvanic separation.

When used in zone 0 the present explosive atmosphere of air mixture and gases, vapours of mists must comply with: $-40^{\circ}\text{C} \leq T_{\text{amb}} \leq 60^{\circ}\text{C}$; $0,08 \text{ Mpa} \leq p \leq 0,11 \text{ Mpa}$.

Design CLM-36Xi can be used in zone 0 or zone 20. With design CLM-36XiT can be used in zone 0 and zone 20 only electrode part an head with electronics can be used only in zone 1 or zone 21.

Ambient temperature: $T_{\text{amb}} = -40^{\circ}\text{C}$ to $+75^{\circ}\text{C}$

Temperature of measured medium according to design variant:

bar non-insulated electrode -40°C to $+200^{\circ}\text{C}$

bar insulated electrode -40°C to $+120^{\circ}\text{C}$

cable with insulated cable -40°C to $+105^{\circ}\text{C}$

Maximum temperature of electrodes is equal to temperature of measured medium.

Maximum input parameters: $U_i = 30 \text{ V}$; $I_i = 132 \text{ mA}$; $P_i = 0,99 \text{ W}$; $C_i = 370 \text{ nF}$; $L_i = 0,9 \text{ mH}$

15. USE, MANIPULATION AND MAINTENANCE

The level meter does not require any personnel for its operation. Follow-up displaying device is used to inform the technological entity operating personnel on the measured substance level height during the operation.

MAINTAINCE OF LEVEL METER

Maintenance of this equipment consists in verification of integrity of the level meter and of the supply cable. Depending on the character of the substance measured, we recommend to verify at least once per year the clarity of the ultrasound transducer emitting field and to clean it, respectively. In case any visible defects are discovered, the manufacturer or reseller of this equipment must be contacted immediately.



The level meter must be installed to prevent tensile overload of the rope electrode, see. Specifications.



It is forbidden to perform any modifications or interventions into the CLM-36 level meter without manufacturer's approval. Potential repairs must be carried out by the manufacturer or by a manufacturer authorized service organization only.

Installation, commissioning, operation and maintenance of the CLM-36 level meter has to be carried out in accordance with this instruction manual; the provisions of regulations in force regarding the installation of electrical equipment have to be adhered to.

REPLACEMENT OF DEFECTIVE ELECTRONIC MODULE

In case of detected electronic failure it is possible to replace the electronic module directly in process place of level meter by following procedure:

1. Disconnect connector and unscrew a nut (attention for inside connecting wires).
2. Defective electronic module pick up by pliers onto brass tie and remove by tensile from housing of level meter.
3. Check placing of white seal O-ring in housing and on pressure ring.
4. Repaired or new electronic module return back into housing of level meter and press down by clamping ring (attention that contact pin will be a little open before insertion and contact springs were not pressed under level of electronic casing).
5. Check placing of black seal O-ring on connector.
6. Screw a nut back (attention for inside connecting wires) and connect the connector.

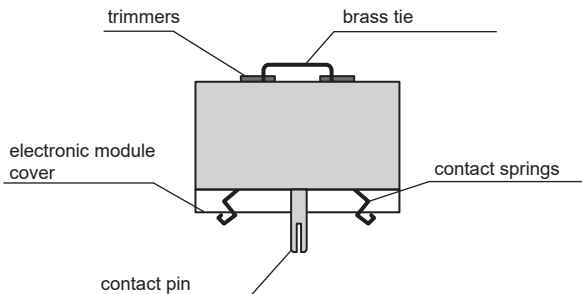

Fig. 12: Side view of the electronic module

PROCEDURE FOR SHORTENING THE MEASURING ELECTRODE ON VARIANT 30

1. At the cable electrode, it is necessary to loosen three fastening screws on the ballast and to pull out the end of the cable, see fig. 13.
2. Make sure that the cable length is correct after shortening – the cable is suspended in the ballast up to a distance of approximately 60 mm. Ideally, shorten the cable using diagonal cutting pliers. Be careful to prevent the end of the cable from fraying.
3. Insert the end of the cable back into the ballast and secure it in place by tightening all three screws.

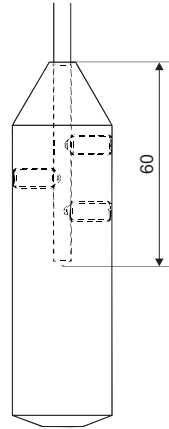

Fig. 13: Drawing of the cable electrode ballast

16. GENERAL, CONDITIONS AND WARRANTY

Dinel, s.r.o. guarantees for the period of three (3) years that the product has the characteristics as mentioned in the technical specification.

Dinel, s.r.o. is liable for defects ascertained within the warranty period and were claimed in writing.

This guarantee does not cover the damages resulting from misuse, improper installation or incorrect maintenance.

This guarantee ceases when the user or the other person makes any changes on the product or the product is mechanically or chemically damaged, or the serial number is not readable.

The warranty certificate must be presented to exercise a claim.

In the case of a rightful complaint, we will replace the product or its defective part. In both cases, the warranty period is extended by the period of repair..

17. MARKING OF LABELS

Labels for device of the type **CLM-36N(T)-__-__-I**:

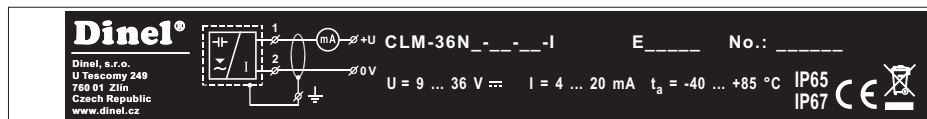

Symbol of producer: logo Dinel®

Contact: Dinel, s.r.o., Zlín, Czech Republic, www.dinel.cz, dinel@dinel.cz

Connection scheme and labelling of wires: +U, 0V, GND

Type of level meter: CLM-36-N-__-__-I, include length of electrode: E in mm

Serial number: Ser. No.: _____ - (from the left: production year, serial production number)

Supply voltage: $U = 9 \div 36$ V DC

Output current range: $I = 4 \div 20$ mA

Ambient temperature range: $t_a = -40 \dots +85$ °C

Protection class: IP 65 / IP 67

Compliance mark: ; Electro-waste take-back system mark:

Labels for device of the type **CLM-36N(T)-__-__-U**:

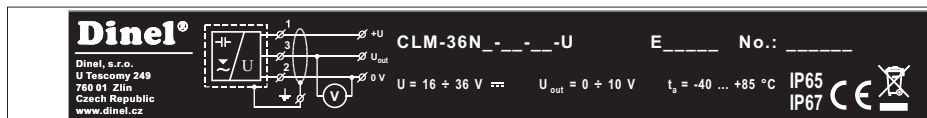

Symbol of producer: logo Dinel®

Contact: Dinel, s.r.o., Zlín, Czech Republic, www.dinel.cz, dinel@dinel.cz

Connection scheme and labelling of wires: +U, 0V, U_{out}, GND

Type of level meter: CLM-36-N-__-__-U, include length of electrode: E in mm

Serial number: Ser. No.: _____ - (from the left: production year, serial production number)

Supply voltage: $U = 16 \div 36$ V DC



Output voltage range: $U = 0 \div 10$ V



Ambient temperature range: $t_a = -40 \dots +85$ °C

Protection class: IP 65 / IP 67

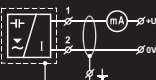

Compliance mark: ; Electro-waste take-back system mark:

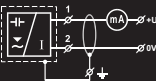
Labels for device of the type **CLM-36Xi (XiT)**:
for types electrodes **10, 20, 30, 31**

 Dinel, s.r.o. U Tescomy 249 760 01 Zlín Czech Republic www.dinel.cz		CLM-36Xi-___-I E _____ No.: _____	IP65 IP67  1026
		II 1 G Ex ia IIB T5 Ga II 1 D Ex ia IIIC T83°C Da FTZÚ 02 ATEX 0235X	

 Dinel, s.r.o. U Tescomy 249 760 01 Zlín Czech Republic www.dinel.cz		CLM-36XiT-___-I E _____ No.: _____	IP65 IP67  1026
		II 1/2 G Ex ia IIB T5 Ga/Gb II 1/2 D Ex ia IIIC T83°C Da/Db FTZÚ 02 ATEX 0235X	

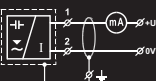
for types electrodes **11, 12, 22, 32**

 Dinel, s.r.o. U Tescomy 249 760 01 Zlín Czech Republic www.dinel.cz		CLM-36Xi-___-I E _____ No.: _____	IP65 IP67  1026
		II 1 G Ex ia IIB T5 Ga FTZÚ 02 ATEX 0235X	

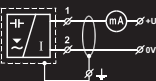
 Dinel, s.r.o. U Tescomy 249 760 01 Zlín Czech Republic www.dinel.cz		CLM-36XiT-___-I E _____ No.: _____	IP65 IP67  1026
		II 1/2 G Ex ia IIB T5 Ga/Gb FTZÚ 02 ATEX 0235X	

Symbol of producer: logo Dinel®

Contact: Dinel, s.r.o., Zlín, Czech Republic, www.dinel.cz, dinel@dinel.cz

Connection scheme and labelling of wires: +U, 0V, GND

Type of level meter: CLM-36-Xi(XiT)-___-, include length of electrode: E in mm

Serial number: Ser. No.: _____ - (from the left: production year, serial production number)

Label of non-explosive device: 

Performance: II 1 G Ex ia IIB T5 Ga, II 1 D Ex ia IIIC T83°C Da

II 1/2 G Ex ia IIB T5 Ga/Gb, II 1/2 D Ex ia IIIC T83°C Da/Db

Number of certificate of intrinsically safety: FTZÚ 02 ATEX 0235X

Limit operating parameters: U_i = 30 V DC, I_i = 132 mA, P_i = 0,99 W, C_i = 370 nF, L_i = 0,9 mH

Ambient temperature range: t_a = -40 ... +75 °C, t_a = -20 ... +60 °C (zone 0)

Protection class: IP 65 / IP 67

Compliance mark: ; No. of authorized person examining control of system quality: 1026

Electro-waste take-back system mark: 



Size of labels 112 x 12 mm, the size shown does not correspond to reality.

18. TECHNICAL SPECIFICATIONS

TECHNICAL SPECIFICATION (variants N, NT)		
Supply voltage	CLM-36N(T)-__-_-I CLM-36N(T)-__-_-U	9 ... 36 V DC 16 ... 36 V DC
Current output Voltage output		4 ... 20 mA 0 ... 10 V *
Power consumption (off-load)	CLM-36N(T)-__-_-U	approx. 8mA
Sensitivity ranges		20; 30; 50; 100; 150; 300; 500; 1000 pF
Initial capacity regulation ratio		min. 1:2
Nonlinearity		max. 1 %
Temperature error		max. 0,05% / K
Voltage error for current and voltage output		max. 0,3 μ A/V and 0,1 mV/V
Internal resistance / Electric strength (Electrode – Housing)		1 M Ω / 250 V AC
Coupling capacity / Electric strength (Housing – Supply leads)		51 nF / 250 V AC
Protection standard class	standard Optional (Connector GAN-DADE 7A / DAEE 7A)	IP67 (Housing), IP65 (Connector) IP67
Maximal load (serial) resistance for current output (U = 24 V)		R _{max} = 750 Ω
Minimal load resistance for voltage output		R _{min} > 1 k Ω
Maximum tensile strength of the rope electrode		1400 kg
Recommended cable		PVC 2x0,75 mm ² (3x0,5 mm ²)
Weight (exclude electrode)	Version N, Xi Version NT, XiT	approx. 0,5kg approx. 1kg

*) Upon request, a different type of output terminal can be produced (e.g. 0 - 5 V)

ELECTRICAL PARAMETERS (variants Xi, XiT)	
Supply voltage	9 ... 30 V DC
Max. internal values	U _i = 30V DC; I _i = 132mA; P _i = 0,99W; C _i = 370nF; L _i = 0,9mH
Internal resistance / Electric strength (Electrode – Housing)	1 M Ω / 250 V AC
Coupling capacity / Electric strength (Housing – Supply leads)	26 nF / 500 V AC
Allowed temperature range in zone 0 (EN 50284)	-20 ... +60°C
Allowed pressure range in zone 0 (EN 50284)	0,08 ... 0,11 MPa

PROCESS CONNECTION

Type	Size	Marking
Metric thread	M36x2	M
Pipe thread	G 1"	G
Jointless connection (Tri-Clamp)	ø 50,5 mm	Cl50

USED MATERIALS

Sensor part	Variants	Standard material	Optional (on request)
Housing	All types	St. Steel W. Nr. 1.4301 (AISI 304)	St. Steel W. Nr. 1.4571 (AISI 316 Ti) St. Steel W. Nr. 2.4858 (Incoloy 825)
Insulating bushing	All types	PTFE	–
Electrode	CLM – 36_–10, 11, 12, 20, 22 CLM – 36_–30, 31, 32	St. Steel W.Nr. 1.4404 (AISI 316 L) St. Steel W.Nr. 1.4401 (AISI 316)	St. Steel W. Nr. 1.4571 (AISI 316 Ti) –
Electrode coating	CLM – 36_–12, 22, 32 CLM – 36_–11 CLM – 36_–31	FEP PFA Polyolefin (modified PE)	– – PTFE
Weight insulation	CLM – 36_–32	PTFE	–
Weight / Anchor mechanism	CLM – 36_–30, 31, 32	St. Steel W. Nr. 1.4301 (AISI 304)	–
Reference tube	CLM – 36_–20, 22	St. Steel W. Nr. 1.4301 (AISI 304)	St. Steel W. Nr. 1.4571 (AISI 316 Ti)

WORKING AREAS AND AREA CLASSIFICATION (EN 60079-0, EN 60079-10-1(2))

CLM – 36N	Basic performance for non-explosive atmospheres.
CLM – 36NT	High-temperature basic performance for non-explosive atmospheres.
CLM – 36Xi (10, 20, 30, 31)	Intrinsically safe explosion-proof performance for use in hazardous areas (explosive gas atmospheres or explosive atmospheres with dust) Ⓜ II 1 G Ex ia IIB T5 Ga; Ⓜ II 1 D Ex ia IIIC T83°C Da with a spark-secure power supply unit, the whole sensor zone 0 and 20.
CLM – 36Xi (11, 12, 22, 32)	Intrinsically safe explosion-proof performance for use in hazardous areas (explosive gas atmospheres) Ⓜ II 1 G Ex ia IIB T5 Ga with a spark-secure power supply unit, the whole sensor zone 0 and 20.
CLM – 36XiT (10, 20, 30, 31)	Intrinsically safe high-temperature explosion-proof performance for use in hazardous areas (explosive gas atmospheres or explosive atmospheres with dust) Ⓜ II 1/2 G Ex ia IIB T5 Ga/Gb; Ⓜ II 1/2 D Ex ia IIIC T83°C Da/Db with a spark-secure power supply unit, electrode part zone 0 and 20, head zone 1 and 21.
CLM – 36XiT (11, 12, 22, 32)	Intrinsically safe high-temperature explosion-proof performance for use in hazardous areas (explosive gas atmospheres) Ⓜ II 1/2 G Ex ia IIB T5 Ga/Gb with a spark-secure power supply unit, electrode part zone 0 and 20, head zone 1 and 21.

TEMPERATURE DURABILITY

Variants / Performance	temperature tm	temperature tp	temperature ta
CLM-36N-10, 20	-40°C ... +300°C	-40°C ... +85°C	-40°C ... +85°C
CLM-36N-11, 12, 22	-40°C ... +200°C	-40°C ... +85°C	-40°C ... +85°C
CLM-36N-30	-40°C ... +200°C	-40°C ... +85°C	-40°C ... +85°C
CLM-36N-31 (incl. PR-31)	-40°C ... +130°C	-40°C ... +85°C	-40°C ... +85°C
CLM-36N-31 (incl. KV-31)	-40°C ... +250°C	-40°C ... +85°C	-40°C ... +85°C
CLM-36N-32	-40°C ... +130°C	-40°C ... +85°C	-40°C ... +85°C
CLM-36Xi-10, 20	-40°C ... +200°C	-40°C ... +75°C	-40°C ... +75°C
CLM-36Xi-11, 12, 22	-40°C ... +120°C	-40°C ... +75°C	-40°C ... +75°C
CLM-36Xi-30	-40°C ... +105°C	-40°C ... +75°C	-40°C ... +75°C
CLM-36Xi-31 (incl.. PR-31)	-40°C ... +105°C	-40°C ... +75°C	-40°C ... +75°C
CLM-36Xi-31 (incl. KV-31)	-40°C ... +105°C	-40°C ... +75°C	-40°C ... +75°C
CLM-36Xi-32	-40°C ... +105°C	-40°C ... +75°C	-40°C ... +75°C
CLM-36NT-10, 20	-40°C ... +300°C	-40°C ... +200°C	-40°C ... +85°C
CLM-36NT-11, 12, 22	-40°C ... +200°C	-40°C ... +200°C	-40°C ... +85°C
CLM-36NT-30	-40°C ... +250°C	-40°C ... +130°C	-40°C ... +85°C
CLM-36NT-31 (incl. PR-31)	-40°C ... +130°C	-40°C ... +130°C	-40°C ... +85°C
CLM-36NT-31 (incl. KV-31)	-40°C ... +250°C	-40°C ... +130°C	-40°C ... +85°C
CLM-36NT-32	-40°C ... +130°C	-40°C ... +130°C	-40°C ... +85°C
CLM-36XiT-10, 20	-40°C ... +200°C	-40°C ... +200°C	-40°C ... +75°C
CLM-36XiT-11, 12, 22	-40°C ... +120°C	-40°C ... +200°C	-40°C ... +75°C
CLM-36XiT-30	-40°C ... +250°C	-40°C ... +130°C	-40°C ... +75°C
CLM-36XiT-31 (incl. PR-31)	-40°C ... +130°C	-40°C ... +130°C	-40°C ... +75°C
CLM-36XiT-31 (incl. KV-31)	-40°C ... +250°C	-40°C ... +130°C	-40°C ... +75°C
CLM-36XiT-32	-40°C ... +130°C	-40°C ... +130°C	-40°C ... +75°C

Note: For correct function of the level meter must not be exceeded any of the temperature range (tp, tm or ta)

1) The temperatures are clearly explained on Fig. 14

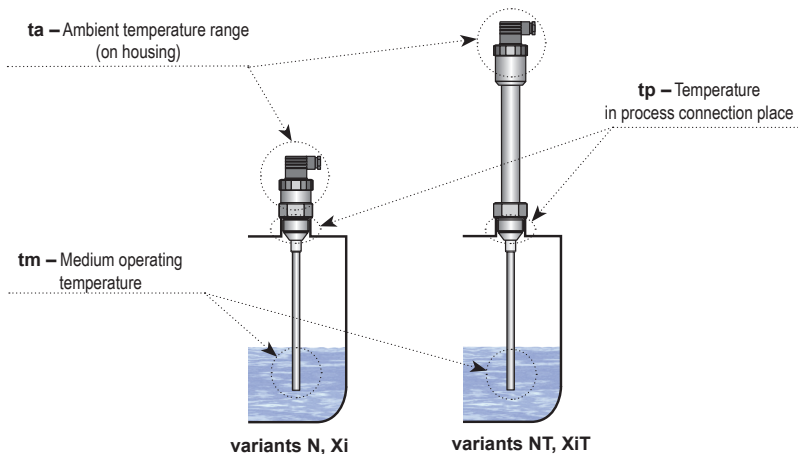

Fig. 14: Points for temperature determination on the level meter

PRESSURE DURABILITY

Variants / Performance	Maximal operation pressure for temperature t_p				
	Up to 30°C	Up to 85°C	Up to 130°C	Up to 160°C	Up to 200°C
CLM-36N-10, 20	7 MPa	5 MPa	–	–	–
CLM-36N-11, 12, 22	4 MPa	2 MPa	–	–	–
CLM-36N-30	7 MPa	5 MPa	–	–	–
CLM-36N-31	–	–	–	–	–
CLM-36N-32	1 MPa	0,5 MPa	–	–	–
CLM-36Xi-10, 20	7 MPa	5 MPa	–	–	–
CLM-36Xi-11, 12, 22	4 MPa	2 MPa	–	–	–
CLM-36Xi-30	7 MPa	5 MPa	–	–	–
CLM-36Xi-31	–	–	–	–	–
CLM-36Xi-32	1 MPa	0,5 MPa	–	–	–
CLM-36NT-10, 20	7 MPa	5 MPa	3 MPa	2 MPa	1 MPa
CLM-36NT-11, 12, 22	6 MPa	4 MPa	2 MPa	1,5 MPa	0,3 MPa
CLM-36NT-30	7 MPa	5 MPa	3 MPa	–	–
CLM-36NT-31	–	–	–	–	–
CLM-36NT-32	1 MPa	0,5 MPa	0,1 MPa	–	–
CLM-36XiT-10, 20	7 MPa	5 MPa	3 MPa	2 MPa	1 MPa
CLM-36XiT-11, 12, 22	6 MPa	4 MPa	2 MPa	1,5 MPa	0,3 MPa
CLM-36XiT-30	7 MPa	5 MPa	3 MPa	–	–
CLM-36XiT-31	–	–	–	–	–
CLM-36XiT-32	1 MPa	0,5 MPa	0,1 MPa	–	–

19. TABLE OF RELATIVE PERMITTIVITY

MATERIAL	ϵ_r	MATERIAL	ϵ_r
Acetone	19,5 + 21,4	Liquefied CO2	1,6
Acetylenetetrachloride	8,1	Liquefied chlorine	2
Aminoplasts	5 + 8	Liquefied propane	1,6 + 1,9
Ammonia	15 + 24	Marble	9,3 + 11,6
Aniline	6,9	Methanol	33
Ash	1,5 + 1,7	Mica	5 + 8
Benzaldehyde	18,3	Mikanite	4,5 + 6
Benzene	2,28 + 2,3	Milk powder	3,5 + 4
Benzol	2,3	Monochlorobenzene	4
Celluloide	3,5 + 6,2	Nitrobenzene	35,7
Cement	4	Ortonitrotoluene	27,4
Diesel	2,1+ 2,2	Paper	1,6 + 2,6
Dioxane	2,235	Paraffin	1,6
Ebonit	2,5 + 5	Paraffin oil	2,0 + 2,2
Ethanol	24	Petroleum	2,0 + 2,2
Ethylacetate	6	Polyacetal	3,6 + 3,7
Ethyleneglycol	38,7	Polyamide - PA	4,0 + 5,0
Ethylenechloride	10,5	Polydichlorstyrole	2,7
Flint crystal	4,5	Polyetheretherketone - PEEK	3,2
Flour	2,5 + 3,0	Polyetherimide - PEI	3
Food salt (NaCl)	6	Polyethylene - PE	2,16
Freon R22	6,1	Polyfenylenesulfide - PPS	3,3
Fused quartz	3,7	Polymethylmetakrylate	2,6
Gasoline (benzin)	2,0 + 2,2	Polypropylene - PP	2,0 + 2,2
Glass	3,7 + 10	Polypropylene - PP (granules)	1,5
Glass organic	3 + 3,6	Polysulphone - PSU	3
Glass silicate	16	Polytetrafluorethylene - PTFE	2,0 + 2,1
Glazed carton	3,5	Polyvinylacetate	2,7
Glycerine	47	Polyvinylchloride - PVC	3,1 + 3,4
Grains	3,0 + 5,0	Polyvinylidene fluoride	6,0 + 7,4
Hardened textile	2 + 6	Porcelain	4,5 + 7
Hexane	1,9	Pyridine	13,6
Chloroforme	4,8	Rape-seed (colza) oil	2,8
Ice	3,1	Resin - acrylic	2,4 + 4,5
Liquefied air	1,5	Resin - epoxy	2,5 + 8,0

MATERIAL	ϵ_r	MATERIAL	ϵ_r
Resin - melamine	4,7 ÷ 10,2	Toluene	2,3 ÷ 2,4
Resin - phenolic	4,0 ÷ 12,0	Trichlorethylene	3,3
Resin - polyester	2,8 ÷ 8,1	Trolitule	2 ÷ 2,6
Resin - styrene	2,3 ÷ 3,4	Vaseline	2,2 ÷ 2,9
Resin - ureal	5,0 ÷ 8,0	Water	81
Rubber	2,0 ÷ 6,0	Water emulsion (with oil)	25
Sand	3,0 ÷ 5,0	Water solution	50 ÷ 80
Silicon caoutchouc	2,8 ÷ 3,3	wax	1,9 ÷ 2,5
Succinite	2,9	White beeswax	2 ÷ 2,9
Sugar	3	Wood - damp	10 ÷ 30
Sulphur	3,4 ÷ 3,6	Wood - dry	2 ÷ 6

20. PACKAGING, SHIPPING AND STORAGE

The device CLM–36 is packaged in a polyethylene bag, and the entire consignment is placed into a cardboard box. A suitable filler material is used in the cardboard box to prevent mechanical damage during transport. Remove the device from the packaging only just before using, thereby protecting it from potential damage.

A forwarding company will be used to ship goods to the customer. Upon prior agreement, ordered goods can be picked up in person at company headquarters. When receiving, please check to see that the consignment is complete and matches the order, or to see if any damage has occurred to the packaging and device during transport. Do not use a device clearly damaged during transport, but rather contact the manufacturer in order to resolve the situation.

If the device is to be further shipped, it must be wrapped in its original packaging and protected against impact and weather conditions.

Store the device in its original packaging in dry areas covered from weather conditions, with humidity of up to 85 % without effects of chemically active substances. The storage temperature range is -10°C to +50°C.



All level meters except type variants CLM–36 –30, 31, 32 are given protective covers at ends of electrodes (longer than 100 mm) and of reference tubes in order to prevent damage to electrode and tubes, tearing of the package or injury of persons handling them. Remove the cover prior to putting into operation.

Dinel[®]

industrial electronics

Dinel, s.r.o.
U Tescomy 249
760 01 Zlín
Czech Republic

Phone: +420 577 002 002
Fax: +420 577 002 007
E-mail: sale@dinel.cz

www.dinel.cz

Find the updated version at www.dinel.cz

version: 01/2019



QMS
ISO 9001

