

- For continuous level measurement of liquids and bulk solids in all industrial branches.
- A wide range of applications, direct installation in storage tanks, vessels, silos, sumps etc.
- Variants with rope, rod or co-axial electrodes.
- Variants with fully coated electrodes for aggressive or electrically conductive media.
- Measured data in real time on the display (OLED or LCD).
- Current output 4–20 mA with HART[®] communication.
- As compared with non-contact level meters, measurement is working in full range (no dead zone at the beginning and end of the electrode).
- Contrary to radar level meters, media with extremely low dielectric constants (ϵ_r) are measured.
- Copying the configuration between level meters using the display module



Capacitive level meters CLM-70 are compact measuring devices consisting of the level meter body and a measuring electrode. The level meter body contains measurement electronics and a display module. The electronics measure the electrical capacity of the electrode system, which depends on the level height. The level meter's electrical output corresponds to the capacity (level height) and the measured data are shown on the meter's display.

The level meter can be adjusted by means of a display and adjustment module positioned at the top of sensor under the transparent lid. The level meter has a 4–20 mA current output with HART[®] communication. The level meter is fed by means of a cable connected to the terminal block located under the display and adjustment module.

Level meters are available in several sensing electrode modifications (rod and rope-type electrodes). Electrodes may be coated with insulation, which is important for their functioning in the case of adherent, electrically conductive and aggressive media. Rod electrodes are also available in a version provided with a reference tube or a pair of parallel electrodes for measuring liquids in non-conductive tanks.

VARIANTS OF SENSORS

- **CLM-70_-00** **Without electrode;** (types 10 or 30 only) and attaches it to the electrode holder using M8 threaded connection.
- **CLM-70_-10** **Uncoated stainless steel rod electrode** for level measurement of electrically non-conductive liquids (oils, diesel fuel) and bulk solids (flour, sand, cement, granulated plastic materials, etc.). Length 0.2 ... 8 m.
- **CLM-70_-11** **Coated stainless steel rod electrode (PFA)** with enhanced resistance to penetration (diffusion) of vapours and gases. For level measurement of water and other electrically conductive liquids in food processing, pharmaceutical, and chemical industries. It can be used temporarily for high-temperature applications (e.g. sanitization with hot steam) or for volatile aggressive liquids, etc. Length 0.2 ... 3 m.
- **CLM-70_-12** **Coated stainless steel rod electrode (FEP),** suitable for level measurement of water and other electrically conductive liquids. Also suitable for impure liquids in metallic tanks, concrete sumps, etc. Length 0.2 ... 3 m.
- **CLM-70_-13** **Semi-coated stainless steel rod electrode (FEP)** for level measurement of electrically non-conductive liquids in environments where partial condensation of vapours on the electrode may occur. Length 0.5 ... 8 m.
- **CLM-70_-20** **Uncoated stainless steel rod electrode with reference tube** for level measurement of unpolluted and electrically non-conductive liquids (oil, diesel fuel, petrol). Length 0.2–3 m.
- **CLM-70_-22** **Coated stainless steel rod electrode (FEP) with reference tube** for level measurement of clean electrically conductive liquids (e.g. in plastic and glass tanks) and for higher measuring accuracy. Length 0.2 ... 3 m.

- **CLM-70_-30** **Uncoated stainless steel rope electrode and weight** for level measurement of bulk solids (sand, flour, cement, etc.). The rope can also be shortened. Length 1 ... 20 m.
- **CLM-70_-31** **Uncoated stainless steel rope electrode and coated dynamic anchor** for measurement of bulk solids in taller silos. Length 1 ... 20 m.
- **CLM-70_-32** **Fully coated stainless steel rope electrode and weight (FEP rope insulation, PTFE weight insulation)**, designed for level measurement of electrically conductive and non-conductive liquids. Length 1 ... 12 m.
- **CLM-70_-61** **Two coated stainless steel rod electrodes (FEP electrode insulation, PTFE head)** for level measurement of aggressive liquids. Length 0.2 ... 2 m.

DIMENSIONAL DRAWINGS

CLM-70_-00

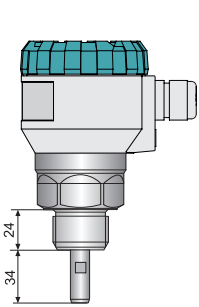

CLM-70_-10

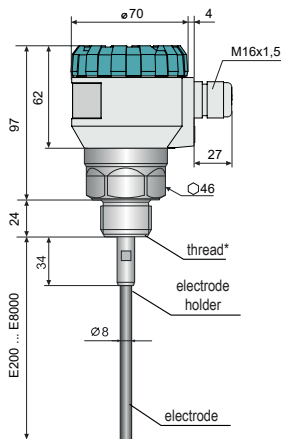

CLM-70_-11, 12

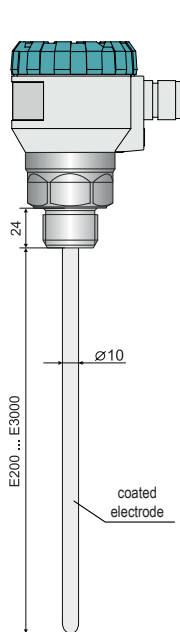

CLM-70_-13

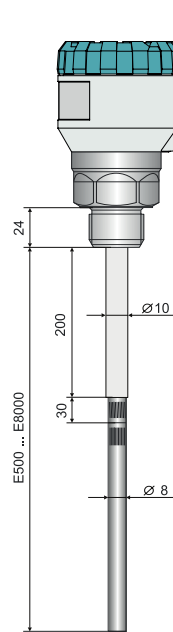

CLM-70_-20, 22

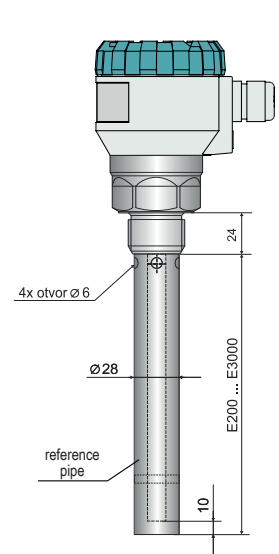

CLM-70_-31

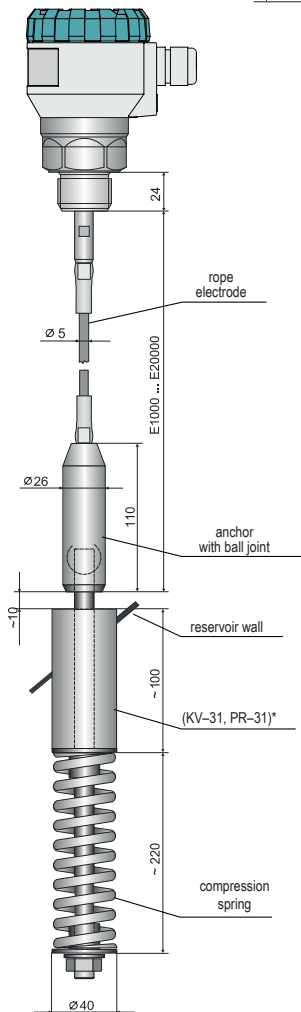

CLM-70_-30

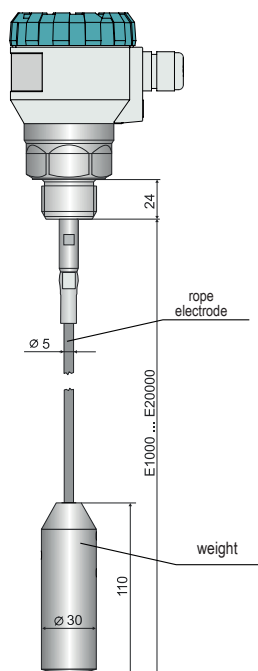

CLM-70_-32

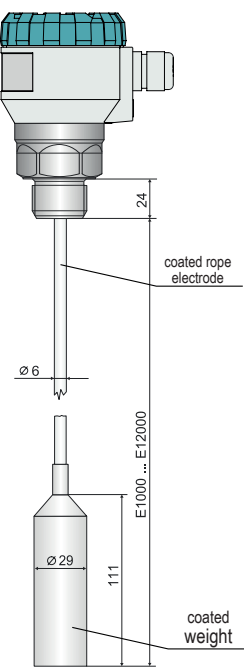

CLM-70_-61

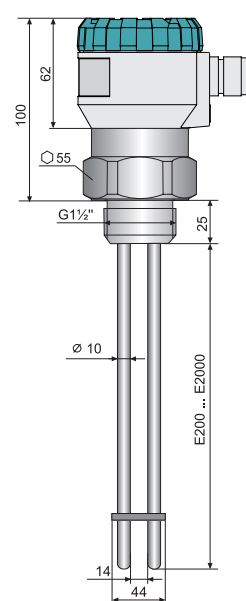

* anchor roll KV-31 or dust proof bushing PR-31 (see accessories)

High temperature performance CLM-70_T**

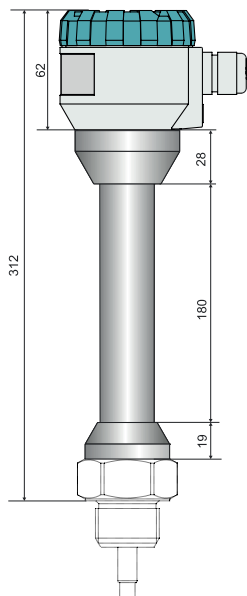

Process connection Tri-clamp***

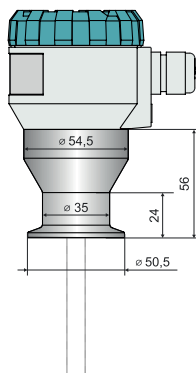

Variant CLM-70 with a bushing for protective hose

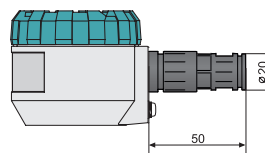

* types of thread: G1" (except type 61), 1" NPT (except type 61)

** Except type CLM-70_61

*** Only for type CLM-70_11(12, 13, 32)

TECHNICAL SPECIFICATIONS

TECHNICAL SPECIFICATIONS - LEVEL METER	
Supply voltage	18 ... 36 V DC
Output	4 ... 20 mA (two-wire), HART®
Current output resolution	10 µA
Capacity range	0 to 3,000 pF
Resolution	0.01 pF for capacities from 0 to 300 pF 0.1 pF for capacities from 300 to 3,000 pF
Temperature error (for a temperature range from -30 to 70 °C)	<1 pF up to 100 pF <1% of the measured value from 100 to 3,000 pF
Measuring frequency	100 to 800 kHz
Non-linearity (electronics)	max. 1%
Damping (time constant)	Adjustable 0 ... 99 sec
Maximum slew rate	<1 sec (0 ... 100%) ; for damping 0 sec
Current output error	max. 80 µA
Display/settings	display module
Protection class	IP67
Maximal resistance of current output load R _{max} for voltage - 24V DC / 22V DC / 20V DC	270 Ω / 180 Ω / 90 Ω ²⁾
Maximum length of measuring electrodes	see dimensional drawing
Ambient temperature range	-30 °C to +70 °C
Recommended cable	PVC 2× 0.75 mm ² shielded
Cable gland tightening torque	3 Nm
Weight - without electrode	approx. 0.5 kg (1 kg NT variant)

TECHNICAL SPECIFICATIONS - DISPLAY MODULE		
Display type	matrix OLED, LCD ¹⁾	
Resolution	128 × 64 pixels	
Digit height / Number of displayed digits of the measured quantity	9 mm / 5 digits	
Display colour	OLED	yellow
	LCD	black with white background light
Type of keys	membrane type with low travel distance	
Ambient temperature range	OLED	-30 ... +70 °C
	LCD	-20 ... +70 °C
Weight	46 g	

1) OLED – suitable for internal applications and applications at reduced lighting levels. LCD – suitable for outdoor applications, especially with direct sunlight.

5) Including resistor 250R with connection with HART.

USED MATERIALS

Sensor part	Variants	Standard material
Lid	All types	aluminium alloy with coating
Glass	All types	polycarbonate
Body	All types	aluminium alloy with coating
Housing with thread	All types, except 61	St. Steel W. Nr. 1.4571 (AISI 316 Ti)
	CLM-70_-61	mat. PTFE
Electrode	CLM-70_-10(11,12,13,20,22,61) CLM-70_-30(31,32)	St. Steel W. Nr. 1.4404 (AISI 316 L) St. Steel W. Nr. 1.4401 (AISI 316)
Electrode coating	CLM-70_-11,61 CLM-70_-12, 13,22,32	PFA FEP
Reference tube	CLM-70_-20,22	St. Steel W. Nr. 1.4301 (AISI 304)
Weight	CLM-70_-30,31	St. Steel W. Nr. 1.4301 (AISI 304)
Weight coating	CLM-70_-32	PTFE
Anchorage	CLM-70_-31	Steel / St. Steel W. Nr. 1.4401 (AISI 316)
Display module	All types	plastic material POM
Cable gland	CLM-70N(NT, Xi, XiT) CLM-70Xd(XdT)	plastic - polyamide metal - nickel-plated brass

DEVICE CLASSIFICATION (according to ČSN EN 60079-10-1 and ČSN EN 60079-10-2)

Sensor performance	electrode type	Device classification
CLM-70N	all types	Basic performance for use in non-explosive areas.
CLM-70NT	all types	High-temperature performance for use in non-explosive areas (max. 200 °C)

PROCESS CONNECTION

name	dimension	marking
Pipe thread	G 1" (G1½ for type CLM-70_-61)	G1 (G1½ for type 61)
Tapered pipe thread	NPT 1"	NPT
Seamless connection – Tri-Clamp	ø 50.5 mm	CI50

TEMPERATURE AND PRESSURE RESISTANCE

performance variant	temperature tm	temperature tp	temperature ta	max. overpressure for temperature tp	
				up to 30 °C	up to 85 °C
CLM-70N-10	-40°C ... +300 °C	-40°C ... +85 °C	-30°C ... +70 °C	15 MPa	10 MPa
CLM-70N-11(12,13)	-40°C ... +200 °C	-40°C ... +85 °C	-30°C ... +70 °C	4 MPa	2,5 MPa
CLM-70N-20	-40°C ... +200 °C	-40°C ... +85 °C	-30°C ... +70 °C	15 MPa	10 MPa
CLM-70N-22	-40°C ... +200 °C	-40°C ... +85 °C	-30°C ... +70 °C	4 MPa	2 MPa
CLM-70N-30 (31 s KV)	-40°C ... +200 °C	-40°C ... +85 °C	-30°C ... +70 °C	15 MPa	10 MPa
CLM-70N-31 s PR	-40°C ... +130 °C	-40°C ... +85 °C	-30°C ... +70 °C	15 MPa	10 MPa
CLM-70N-32	-40°C ... +130 °C	-40°C ... +85 °C	-30°C ... +70 °C	1 MPa	0.5 MPa
CLM-70N-61	-40°C ... +200 °C	-40°C ... +85 °C	-30°C ... +70 °C	0.1 MPa	0.1 MPa

TEMPERATURE RESISTIVITY (high-temperature performance)

performance variant	temperature tm	temperature tp	temperature ta
CLM-70NT-10	-40°C ... +300 °C	-40°C ... +200 °C	-30°C ... +70 °C
CLM-70NT-11(12,13)	-40°C ... +200 °C	-40°C ... +200 °C	-30°C ... +70 °C
CLM-70NT-20(22)	-40°C ... +200 °C	-40°C ... +200 °C	-30°C ... +70 °C
CLM-70NT-30 (31 s KV)	-40°C ... +200 °C	-40°C ... +130 °C	-30°C ... +70 °C
CLM-70NT-31 s PR	-40°C ... +130 °C	-40°C ... +130 °C	-30°C ... +70 °C
CLM-70NT-32	-40°C ... +130 °C	-40°C ... +130 °C	-30°C ... +70 °C
CLM-70NT-61	-	-	-

Note: For correct operation of the level meter, none of the specified temperature ranges (tp, tm or ta) must be exceeded.

PRESSURE RESISTIVITY (high-temperature performance)

performance variant	maximum overpressure for temperature t_p				
	up to 30 °C	up to 85 °C	up to 130 °C	up to 160 °C	up to 200 °C
CLM-70NT-10(20, 30)	15 MPa	10 MPa	3 MPa ¹⁾	2 MPa ¹⁾	1 MPa ¹⁾
CLM-70NT-11(12,13,22)	4 MPa	2.5 MPa	2 MPa	1.5 MPa	0.3 MPa
CLM-70NT-32	1 MPa	0.5 MPa	0.1 MPa	-	-
CLM-70NT-61(31)	-	-	-	-	-

1). The above-mentioned values do not apply to hot water, aqueous solutions and steam, in such cases the use must be consulted with the manufacturer.

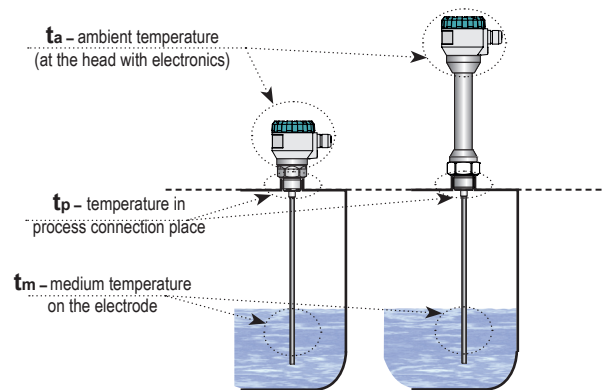

Fig. 1: Illustration of temperature measurement areas

ELECTRICAL CONNECTION

The level meter is connected to the follow-up (evaluation) device using a suitable cable with an outer diameter of 6–8 mm by means of screw terminals located under the display module. The recommended wire cross-section is $2 \times 0.5\text{--}0.75 \text{ mm}^2$ (shielded) for the current version. The positive pole (+U) is connected to the (+) terminal, the negative pole (0 V) to the (-) terminal, and the shield (only for shielded cables) is connected to the (\perp) terminal.

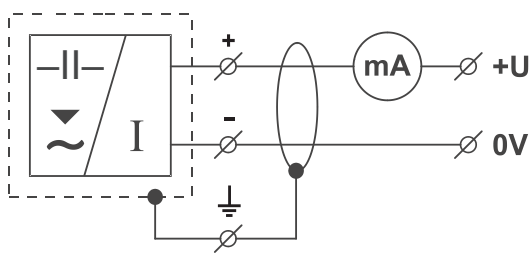

Fig. 2: Connection diagram of level meter with current output CLM-70-_-_-I

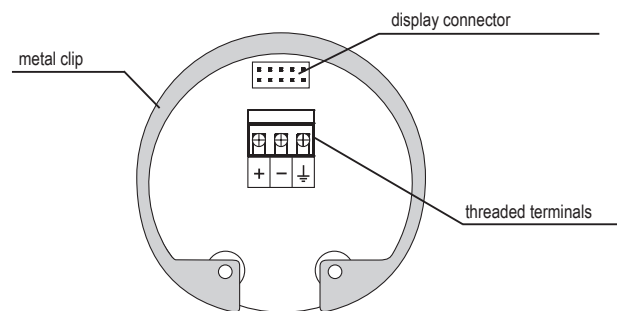

Fig. 3: Internal view of threaded terminals of level meter with current output CLM-70-_-_-I

SETTING ELEMENTS

Setting is done using the 3 buttons located on the DM-70 display module. All setting items are available in the level meter menu.

Button

- access to the setting menu
- acknowledgement of the selected menu item
- cursor movement in line
- saving settings

Button

- navigation in menu
- changing values

Button

- cancelling changes
- moving up a level

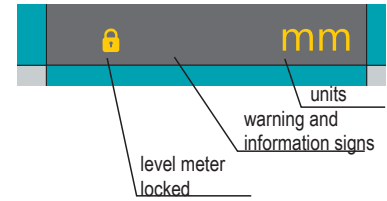
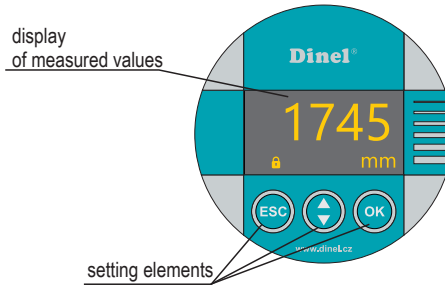

** flashes intermittently when receiving a reflected signal (echo) from the measured level*

 The level meter, type CLM-70_--_--_--L, is supplied without the DM-70 display module. To set up the level meter it is necessary to connect a display module (or it can be configured via HART). When the set-up is complete, the display module can be disconnected and the level meter takes measurements without it.

STATUS AND FAILURE SIGNALIZATION

• Status indication (lower left corner of the display):

symbol  – lights permanently – the level meter is locked against unauthorized settings; a password is required for unlocking (see MENU – PASSWORD)

• Warning signs:

FIXED OUTPUT – the output current is fixed to a constant value (see MENU – DIAGNOSTIC – CURRENT)

LOW POWER – low supply voltage (it must be within the specified range – see TECHNICAL SPECIFICATIONS)

NO PASSWORD – when changing the locked level meter settings

• Information signs:

CAPACITY – actual capacity displayed (see DIAGNOSTIC – CAPACITY)

CURRENT – actual current displayed (see DIAGNOSTIC – CURRENT)

ORDER CODE

PRODUCT

CLM-70

PERFORMANCE

- N** non-explosive areas
- NT** high temperature performance, non-explosive areas

TYPE AND PERFORMANCE OF ELECTRODE

00	without electrode, CI50 process connection cannot be selected
10	uncoated stainless steel rod electrode, length 0.2 ... 8 m, CI50 process connection cannot be selected
11	fully coated stainless steel rod electrode (PFA insulation), length 0.2 ... 3 m, NPT process connection cannot be selected
12	fully coated stainless steel rod electrode (FEP insulation), length 0.2 ... 3 m, NPT process connection cannot be selected
13	semi-coated rod electrode (FEP insulation), NPT process connection cannot be selected, length 0.5 ... 8 m
20	uncoated stainless steel rod electrode with reference tube, can only be used with G1 process connection, length 0.2 ... 3 m
22	coated stainless steel rod electrode with reference tube (FEP insulation), can only be used with G1 process connection, length 0.2 ... 3 m
30	uncoated rope electrode, length 1 ... 20 m, CI50 process connection cannot be selected
31	uncoated rope electrode with anchor, length 1 ... 20 m, CI50 process connection cannot be selected
32	electrode with insulated cable (FEP) and insulated weight (PTFE), length 1 ... 12 m, NPT process connection cannot be selected
61	two fully coated stainless steel rod electrodes (FEP insulation), length 0.2 ... 2 m, not applicable for NT performance, can only be used with G1½ process connection

PROCESS CONNECTION

- G1** pipe thread G1", cannot be selected for performance type 61
- G1½** pipe thread G1½", can only be selected for performance type 61
- CI50** Tri-Clamp Ø 50.5 mm, can only be selected for performance types 11, 12, 13, 32
- NPT** NPT 1" thread, can only be selected for performance types 00, 10, 30, 31, cannot be used for NT performance type

OUTPUT TYPE

- I** current (4 ... 20 mA)

ELECTRICAL CONNECTION

- B** short cable gland
- H** cable gland for protective hose

SET-UP ELEMENTS

- D** basic version with OLED display
- C** version with LCD display
- L** without display, full cap

LENGTH OF ELECTRODE

- E** electrode length in mm

CLM-70 N - 11 - G1 - I - B - D E 1000

AVAILABLE PRODUCT ALTERNATIVES

CORRECT SPECIFICATION EXAMPLES

CLM-70N-10-G1-I-B-D E1000

(N) Non-explosive areas; (10) uncoated stainless steel rod electrode; (G) Process connection – G1" thread; (I) Output type – current; (B) Connection method – short cable gland; (D) Setting elements – basic version with OLED display; Electrode length – 1000 mm.

CLM-70NT-12-G1-I-H-L E1000

(NT) High temperature performance; (12) coated stainless steel rod electrode (FEP); (G) Process connection – G1" thread (I) Output type – current; (H) Connection method – cable gland for protective hose; (L) Setting elements – without display, full cap; Electrode length – 1000 mm.

ACCESSORIES

standard (included in the price of the unit)

- 1× seal (asbestos-free), other seals by request (PTFE, Al, etc.)*

optional (for an extra fee)

- steel welding flange ON-G1, G1½
- stainless steel welding flange NN-G1, G1½
- fixing nut UM-G1, G1½ (stainless steel, plastic)
- anchor roll KV-31 (for CLM-70-31 only)
- dust proof bushing PR-31 (for CLM-70-31 only)
- extension cable for PK-70-1 display

* Except type 61. For pressure resistance see the table in the accessories datasheet – seals.

SAFETY, PROTECTION, COMPATIBILITY AND EXPLOSION PROOF

The level meter is equipped with protection against fault voltage on the electrode, supply voltage polarity reversal, short-term overvoltage, and current overload on the output.

Protection against direct contact is ensured:

- by safe voltage ČSN 33 2000-4-41

Electromagnetic compatibility is in accordance with the following standards:

- ČSN EN 55 011 (B), ČSN EN 61326-1, ČSN EN 61000-4-2 (A, 30kV)
- ČSN EN 61000-4-3 (A, 10V), ČSN EN 61000-4-4 (A, 2kV)
- ČSN EN 61000-4-5 (A, 2kV), ČSN EN 61000-4-6 (A, 10V)

This equipment has been issued with a Declaration of Conformity pursuant to Act No. 90/2016 Sb., as amended. The electrical equipment supplied complies with the requirements of applicable government regulations on safety and electromagnetic compatibility.