



## HIGH-FREQUENCY LEVEL SENSOR RFLS-28

---





# CONTENTS

---

1. Basic description.....	5
2. Sensor variants.....	5
3. Dimensional drawing .....	6
4. Installation and putting into operation.....	7
5. Electrical connection.....	8
5.1. Type RFLS-28N-_-_-P-_- electrical connection .....	8
5.2. Type RFLS-28N-_-_-PD-_- electrical connection.....	9
6. Settings elements .....	11
7. Status indication .....	12
8. Settings.....	13
8.1. Settings using the magnetic pen - RFLS-28-_-_-P/PD-_- .....	15
8.2. Settings RFLS-28-_-_-PD-_- using the SSU-1212-AD unit .....	16
8.3. Settings “medium window” mode – media resolution function .....	20
9. Mechanical mounting .....	22
10. Sensor variant with the “PD” output with diagnostics .....	26
11. Order code.....	27
12. Accessories .....	28
13. Resilience of O-rings.....	29
14. Safety, protection, and compatibility .....	30
15. Functional safety.....	30
16. Use, operation, and maintenance .....	30
17. Putting out of operation or disposal .....	31
18. General conditions and warranty .....	31
19. Product marking .....	32
20. Technical parameters.....	33
21. Packing, shipping, and storage.....	35

## SYMBOLS USED

---

To ensure the maximum safety of control processes, we have defined the following safety instructions and information. Each instruction is labelled with the appropriate pictogram.



### **Alert, warning, danger**

This symbol informs you about particularly important instructions for installation and operation of the equipment or dangerous situations that may occur during installation and operation. Not observing these instructions may cause disturbance, damage, or destruction of the equipment or may cause injury.



### **Information**

This symbol indicates particularly important device characteristics.



### **Note**

This symbol indicates helpful additional information.

## SAFETY

---



All operations described in this instruction manual must only be carried out by trained personnel or by an accredited person. Warranty and post warranty service must be exclusively carried out by the manufacturer.

Improper use, installation, or adjustment of the sensor can lead to application failures (**overfilling tanks or damage to system components**).

**The manufacturer is not responsible for improper use, loss of work caused by either direct or indirect damage, or for expenses incurred at the time of installation or during the period of use of the level sensors.**



# 1. BASIC DESCRIPTION

The **RFLS-28 high-frequency level sensor** is designed for industrial use for limit sensing of liquid and paste media. The high-frequency level sensor may be a direct replacement for a vibrating level sensor, or for a capacitive level sensor in the case of more demanding applications. The media may be electrically conductive or non-conductive with any permittivity. The sensor can be installed in metal or plastic tanks, filling tanks, sumps, etc.

The RG variant can be installed using the TN-28 extension tube or in a similar way.

The sensor works on the high frequency band, enabling reliable detection of the level of media, and eliminating deposits or foam on the electrode. The sensor suppresses the influence of deposits of viscous media (ketchup, yoghurt, mayonnaise, pâtés, syrups, jams, creams, soap) as well as electrically conductive adhesive products (detergents, lyes, chemicals).

The sensor can be set up by applying a magnetic pen to sensitive spots (variants RFLS-28\_ \_ \_ -P/PD-\_) or using the programming wire (variant RFLS-28\_ \_ \_ -PD-). For remote parametrization using the programmable wire, the special SSU-1212-AD unit is used.

The sensors can be set to perform:

- simple sensing of the presence of the medium (medium/air)
- distinction of the interface between two media (medium/medium), e.g. water/oil
- selective distinction of a specific medium (medium window function), the function can distinguish e.g. oil from water and air, or detect only beer foam and ignore beer and air, etc.

The sensor is made from a stainless steel housing at one end terminated by a sensing electrode, and terminated at the other end and by an enclosure with a status indicator, control elements, and electrical connection. The setting elements are on the sides of the sensor. The sensors are manufactured for use in non-explosive areas only.

# 2. SENSOR VARIANTS

VARIANTS		
name	minimum temperature	type
RFLS-28_1B	from -40°C	NBR O-ring, for sensing various liquids, mashed and paste materials, also appropriate for oil
RFLS-28_10B	from -40°C	with protective crown, NBR O-ring, for sensing various liquids, mashed and paste materials, also appropriate for oil
RFLS-28_1E	from -40°C	EPDM O-ring, for sensing various liquids, mashed and paste materials, also appropriate for acids or bases
RFLS-28_10E	from -40°C	With protective crown, EPDM O-ring, for sensing various liquids, mashed and paste materials, also appropriate for acids or bases
RFLS-28_1V	from -20°C	FPM (Viton) O-ring, for sensing various liquids, mashed and paste materials, also appropriate for oil, acids, bases, or asphalt and tar
RFLS-28_10V	from -20°C	with protective crown, FPM (Viton) O-ring, for sensing various liquids, mashed and paste materials, also appropriate for oil, acids, bases, or asphalt and tar

### 3. DIMENSIONAL DRAWING

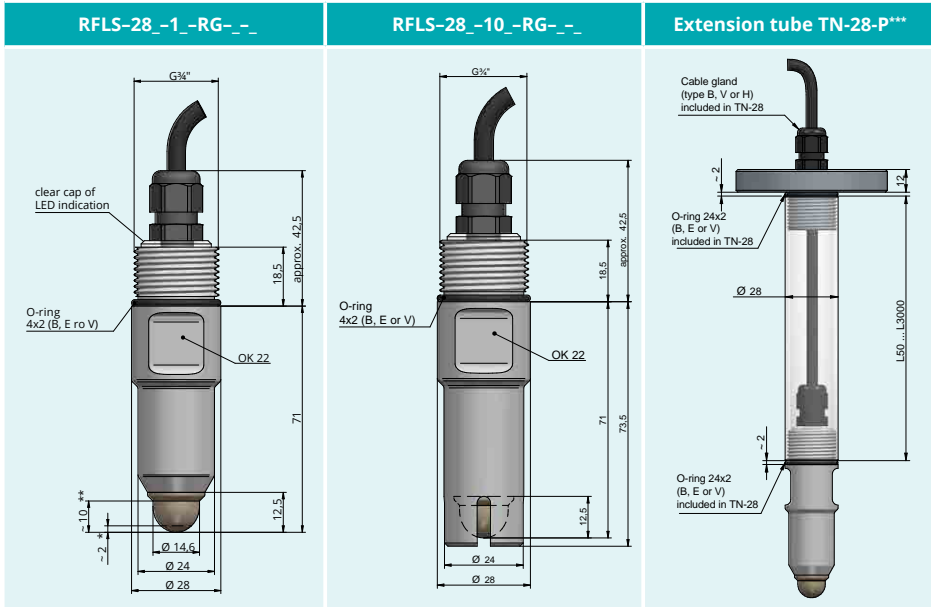

The switching point is the same for both sensor variants.  
 \* Typical switching point position for water (factory default).  
 \*\* Typical switching point position for oil.

\*\*\* Extension tube variants:  
**P - flange** (in figure),  
**Z - thread G1", CI - Tri-Clamp**  
 see the accessories data sheet for the TN-28 extension tube

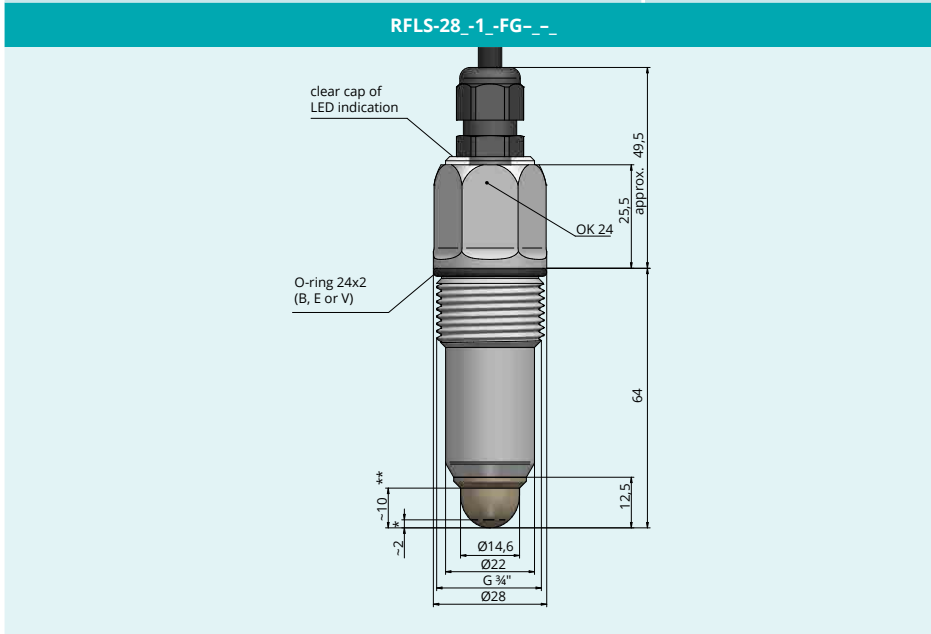

**Variant “B” with a standard cable gland**

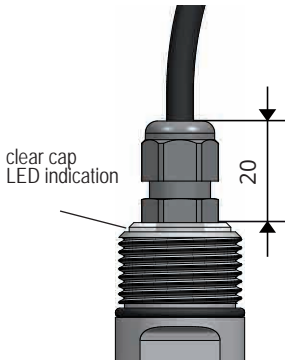

**Variant “V” with plastic cable gland with spiral relief – in the case of increased mechanical wear on the cable.**

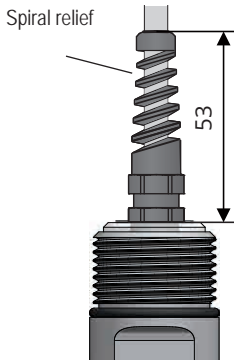

**Variant “H” with cable gland for protective hoses – for use in an outdoor area or in an area with high humidity.**

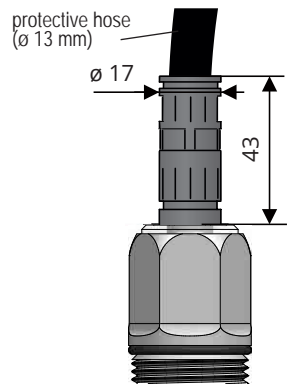
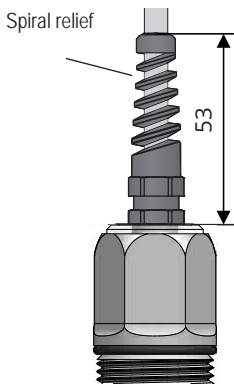
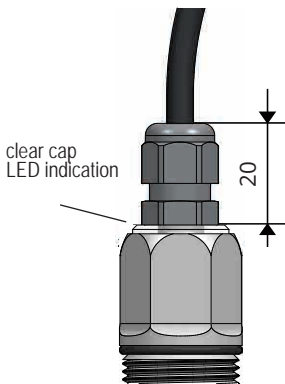
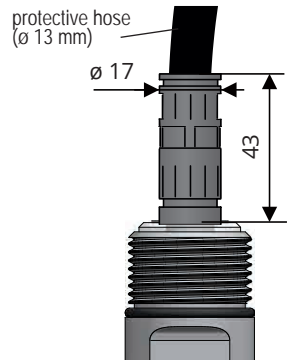

## 4. INSTALLATION AND PUTTING INTO OPERATION

Please follow the next 3 steps:

- For **ELECTRICAL CONNECTION**, see chapter **5**
- For **SETTINGS**, see chapter **8**
- For **MECHANICAL ASSEMBLY**, see chapter **9**

## 5. ELECTRICAL CONNECTION



The electrical connection can only be made when de-energised!



If the level meter (sensor) is to be installed in an outdoor environment more than 20 m from an outdoor switchboard or an enclosed building, the electrical supply to the level meter (sensor) must be supplemented with suitable overvoltage protection.

In the case of strong environmental electromagnetic interference, common routing of the signal cable with the power cable or if the length is more than 30 m, we recommend using a shielded cable and grounding the shielding on the power source side.

### 5.1. Type RFLS-28N-\_-P- electrical connection

RFLS-28-\_-P sensors are permanently connected to evaluation units by a PVC cable.

Sensors with PNP output can only be loaded with a resistive or inductive load. The capacitive loads and low resistance loads (bulb) are evaluated by the sensor as a short circuit.

Connection diagrams are listed in the figure below.

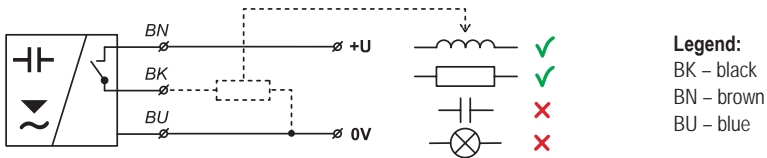

Fig. 1: Connection of the RFLS-28-\_-P- sensor with PNP output



The power supply must be designed as a stabilised source of low safe voltage with galvanic isolation. If a switched power supply is used, its design must effectively suppress common mode interference. If the switched power supply is equipped with a PE protective terminal, it must be strictly earthed!

## 5.2. Type RFLS-28N-\_-\_-PD-\_ electrical connection

### 5.2.1. Connection to the SSU-1212-D unit – diagnostic function only

The SSU-1212-D power supply and switching unit is intended for the evaluation of the state of the connected sensor and its transformation to a power contact. In addition, the unit is able to evaluate diagnostic messages generated by the connected sensor. The programming wire P is not connected to the unit and its end must be properly insulated.

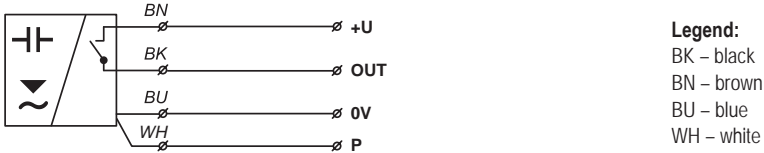

Fig. 2: Connection of the RFLS-28-\_-\_-PD-\_ sensor with PNP output and diagnostic function

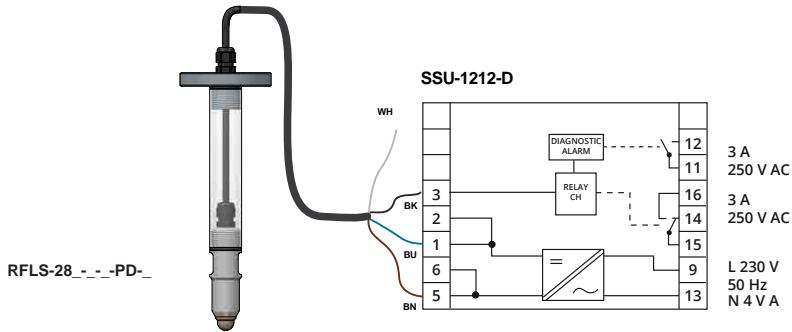
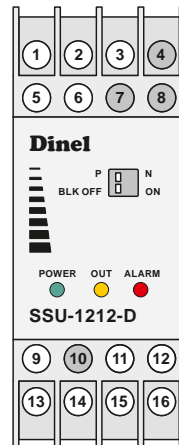

Fig. 3: Connection of the sensor to the SSU-1212-D unit

PNP output type sensor connection	
+U sensors	terminal No. 5 or 6
Q output of the sensor	terminal No. 3
0 V of the sensor	terminal No. 1 or 2
programming wire P	not connected

Legend	
BK	black
WH	white
BU	blue
BN	brown



### 5.2.2. Connection to the SSU-1212-AD unit – diagnostic function + remote settings

The SSU-1212-AD power supply and switching unit is intended for the evaluation of the state of the connected sensor and its transformation to a power contact. In addition, the unit is able to evaluate diagnostic messages generated by the connected sensor and set it remotely.

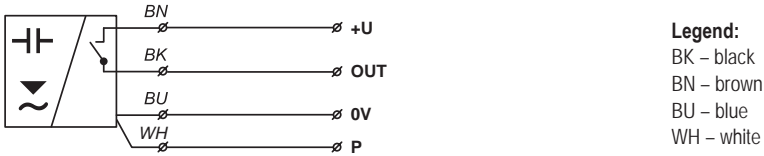

Fig. 2: Connection of the RFLS-28\_--PD\_ sensor with PNP output and diagnostic function

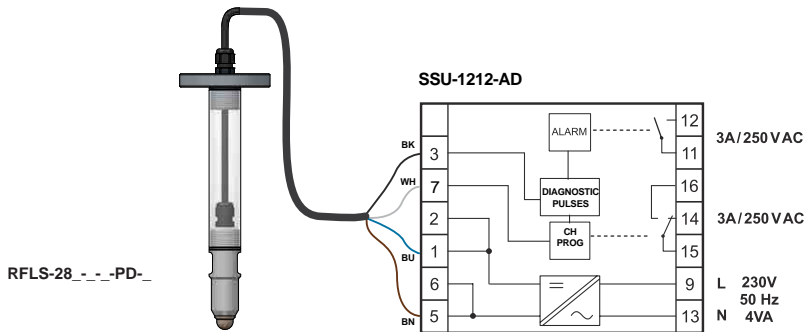
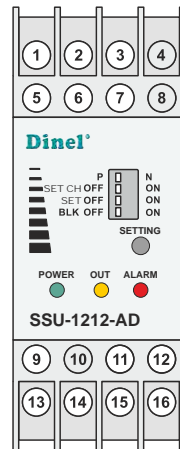

Fig. 3: Connection of the sensor to the SSU-1212-AD unit

PNP output type sensor connection	
+U sensors	terminal No. 5 or 6
Q output of the sensor	terminal No. 3
0 V of the sensor	terminal No. 1 or 2
programming wire P	terminal No. 7

Legend	
BK	black
WH	white
BU	blue
BN	brown



## 6. SETTINGS ELEMENTS

The settings elements are used to set the sensitivity and behaviour of the sensor. The RFLS-28 sensor can always be set using a magnetic pen by touching the ON or OFF magnetically sensitive spots on the sensor. The RFLS-28N-\_-\_- PD-\_- variant is also fitted with a setting wire for remote parametrisation of the sensor. Remote parametrisation enables all the same sensor options to be set as when setting with the magnetic pen.

With the RFLS-28N-RG-\_- P -\_- variant with no option of remote parametrisation, settings needs to be performed before the sensor is installed in the tank, because setting is unavailable after installation in the tank.

- **Quick settings** – the user does not know precisely what medium the sensor should be set to, but just wants to start up the sensor (usually upon receiving it) and check to see if the sensor is generally functional.
- **Basic settings** – the user has the medium available and can perform flooding and drainage on the sensor.
- **Medium window settings** – the user has the medium available and can perform flooding and drainage on the sensor.

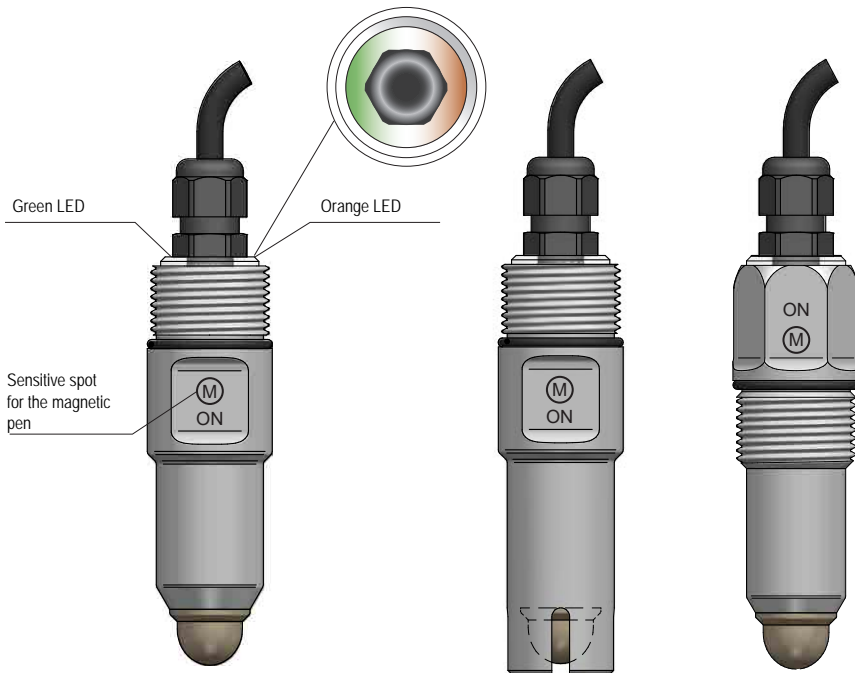

Fig. 4: Positions of the settings and indication elements on the sensor

# 7. STATUS INDICATION





Function		indication on the sensor	indication on the unit
standard operation sensor open			
standard operation sensor closed			
incorrect setting			
setting up	magnetic pen application		the status is unchanged
	settings confirmation		
PD version only	sensor malfunction status open		
	sensor malfunction status closed		





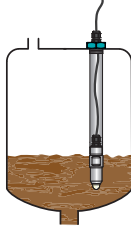

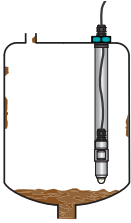
## 8. SETTINGS

### SETTINGS MODES FOR THE RG, RN VARIANTS

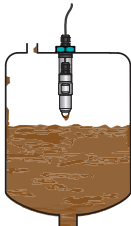
The sensor can be set to normally closed “O-mode” or to normally open “C-mode” switch types.

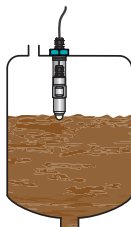



	level state	mode	output state	Orange LED
minimum level sensing		O	CLOSED	 (illuminated)
		O	OPEN	 (not illuminated)



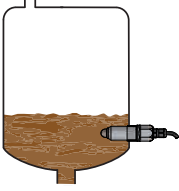

	level state	mode	output state	Orange LED
maximum level sensing		C	CLOSED	 (illuminated)
		C	OPEN	 (not illuminated)

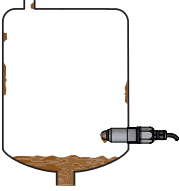
For safety reasons, for scanning min. level, we recommend setting “O-mode” (sensor closes when submerged). A faulty sensor or wiring will take effect here in the same way as level emergency conditions by opening the sensor. Analogously, for the max. level, we recommend setting “C-mode” (sensor opens when submerged).

## SETTINGS MODES FOR THE FG, FN VARIANTS

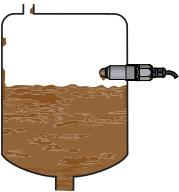
The sensor can be set to normally closed “O-mode” or to normally open “C-mode” switch types.

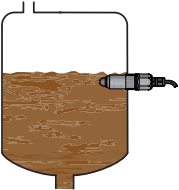
	level state	mode	output state	Orange LED
minimum level sensing		O	CLOSED	 (illuminated)
		O	OPEN	 (not illuminated)

	level state	mode	output state	Orange LED
maximum level sensing		C	CLOSED	 (illuminated)
		C	OPEN	 (not illuminated)

*For safety reasons, for scanning min. level, we recommend setting “O-mode” (sensor closes when submerged). A faulty sensor or wiring will take effect here in the same way as level emergency conditions by opening the sensor. Analogously, for the max. level, we recommend setting “C-mode” (sensor opens when submerged).*

## 8.1. SETTINGS USING THE MAGNETIC PEN - RFLS-28\_-\_ -P/PD-\_\_



Settings needs to be performed prior to installing the sensor in the TN-28 extension tube.

With the RFLS-28N-RG-\_\_ - P \_\_ variant with no option of remote parametrisation, settings needs to be performed before the sensor is installed in the tank, because setting is unavailable after installation in the tank.

While setting up the RFLS-28 sensor, it is important to monitor both LEDs. Therefore, settings must be performed before installing the sensor in the extension tube.

### INSTRUCTIONS FOR SETTINGS:

- Install the electrical connection – see Chapter 5
- In the case of simple sensing of non-adhering media, you can use the **Quick settings** specified in chap. 8.1.1. Otherwise, **it is necessary** to perform the **Basic settings - with the medium present**.
- Prepare the measured medium in an auxiliary vessel.
- If you want to sense the presence of the medium (medium/air) or detect the interface of two different media (medium/medium), such as water/oil, follow the instructions provided in chap. 8.1.2. Basic settings.
- If you want to selectively detect a specific medium, follow the instructions provided in chap. 8.1.3. setting up “medium window” mode.

### 8.1.1. QUICK SETTINGS – WITHOUT THE MEDIUM PRESENT

This mode is only suitable for verifying the sensor before commissioning if the measured medium is not available.

#### A) SETTING O-MODE (CLOSES WHEN SUBMERGED)

1. The sensor is turned with the measuring electrode into the free space.
2. Apply the magnetic pen for **at least 5 to 10 seconds** to the ON sensitive spot  on the sensor (at first, both LEDs light up. After approx. 3 seconds, the orange LED flashes 3 times, and after another approx. 2 seconds the orange LED flashes again 3 times. You can now remove the magnetic pen).  
The sensor is now set to O-mode (closes when submerged).

#### B) SETTING C-MODE (OPENS WHEN SUBMERGED)

1. The sensor is turned with the measuring electrode into the free space.
2. Apply the magnetic pen for **at least 5 to 10 seconds** to the OFF sensitive spot  on the sensor (at first, both LEDs light up. After approx. 3 seconds, the orange LED flashes 3 times, and after another approx. 2 seconds the orange LED flashes again 3 times. You can now remove the magnetic pen).  
The sensor is now set to C-mode (opens when submerged).



Unless otherwise agreed, “O-mode” is set on all sensors straight from the factory.



When using the “quick settings” function, the sensor does not eliminate the presence of deposits and foam on the electrode. The manufacturer recommends performing the basic settings as soon as possible.

### 8.1.2. BASIC SETTINGS – WITH THE MEDIUM PRESENT

For setting the sensitivity and switching mode, where it is possible to submerge the sensor in or remove it from the medium. When using this setting, the sensor eliminates the presence of deposits and foam on the electrode.

#### A) SETTING O-MODE (CLOSES WHEN SUBMERGED)

1. Immerse the sensor electrode in the medium to be measured (in the case of the detection of a two-media interface, place the electrode in the lower medium).
2. Apply the magnetic pen for **2 to 4 seconds** to the ON sensitive spot (M) of the sensor (until both LEDs are illuminated) and then remove the magnetic pen. The settings are confirmed by three flashes of the orange LED.
3. Take the sensor out of the medium (in the case of the detection of a two-media interface, place the electrode in the upper medium). Leave any deposits on the electrode.
4. Apply the magnetic pen for **2 to 4 seconds** to the OFF sensitive spot (M) of the sensor (until both LEDs are illuminated) and then remove the magnetic pen. The settings are confirmed by three flashes of the orange LED.
5. Check the status of the indicators:
  - If the orange LED is not illuminated and the green LED is flashing, the sensor is correctly set.
  - If the orange and green LEDs are flashing alternately, the sensor did not recognise the limits for closing and opening. In this case, find out whether the minimum and maximum levels have been set too close to one another.

#### B) SETTING C-MODE (OPENS WHEN SUBMERGED)

1. Immerse the sensor electrode in the medium to be measured (in the case of the detection of a two-media interface, place the electrode in the lower medium).
2. Apply the magnetic pen for **2 to 4 seconds** to the OFF sensitive spot (M) of the sensor (until both LEDs are illuminated) and then remove the magnetic pen. The settings are confirmed by three flashes of the orange LED.
3. Pull the sensor out of the medium. (when detecting a two-media interface, place the electrode in the upper medium). Leave any deposits on the electrode.
4. Apply the magnetic pen for **2 to 4 seconds** to the ON sensitive spot (M) of the sensor (until both LEDs are illuminated) and then remove the magnetic pen. The settings are confirmed by three flashes of the orange LED.
5. Check the status of the indicators:
  - If the orange LED is illuminated and the green LED is flashing, the sensor is correctly set.
  - If the orange and green LEDs are flashing alternately, the sensor did not recognise the limits for closing and opening. In this case, find out whether the minimum and maximum levels have been set too close to one another and repeat the set-up if necessary.



*For safety reasons, we recommend setting "O-mode" for level sensing (the sensor closes when submerged). A faulty sensor or wiring will take effect here in the same way as level emergency conditions by opening the sensor. Analogously, for the maximum level, it is recommended to set "C-mode" (the sensor opens when submerged).*

### 8.1.3. SETTINGS "MEDIUM WINDOW" MODE – MEDIA RESOLUTION FUNCTION

The sensor can also be used to distinguish a specific medium from others – using the "medium window" function. E.g. the sensor can distinguish oil from water and air, detect only beer foam and ignore beer and air, etc. To set the sensitivity and switching mode for the required medium. With this setting, the sensor does not react to being submerged in a medium with a different permittivity.

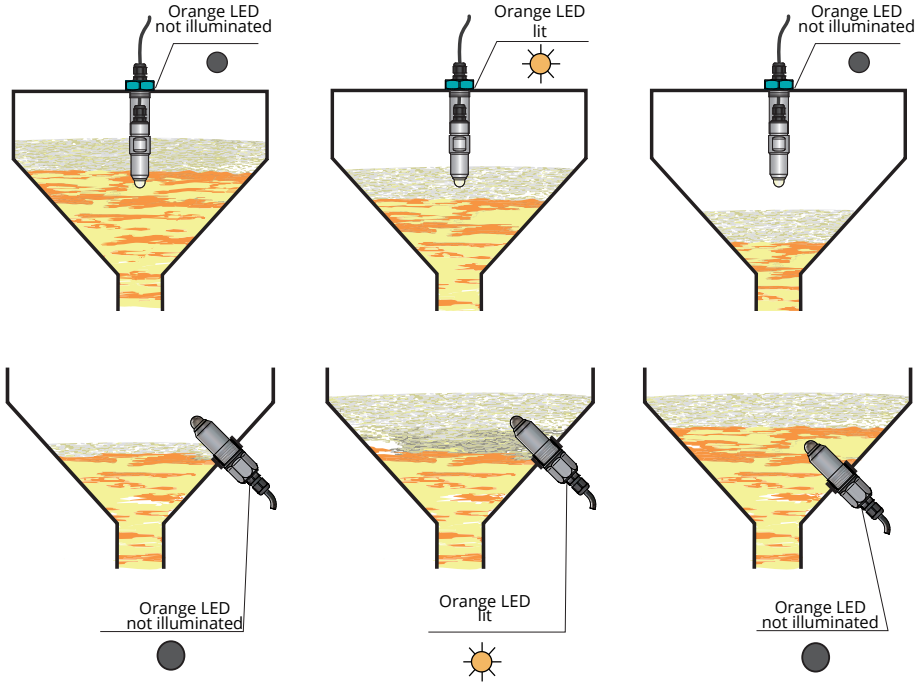



Fig. 5: "Medium window" mode – only detection of the required medium:  
(e.g.: only beer foam, beer and air are ignored)

#### A) SETTING O-MODE (THE SENSOR CLOSSES WHEN SUBMERGED IN THE REQUIRED MEDIUM)

1. Immerse the sensor electrode in the medium to be measured.
2. Apply the magnetic pen for **at least 10 seconds** to the ON sensitive spot (M) of the sensor (at first both LEDs are illuminated. After approx. 3 seconds, the orange LED flashes 3 times. After another approx. 2 seconds the orange LED flashes again 3 times, and after approx. 5 seconds the orange LED flashes 3 times again. You can now remove the magnetic pen).  
The sensor is now set to O-mode (closes when submerged in the required medium).
3. Check the status of the indicators:
  - If the orange LED is illuminated and the green LED is flashing, the sensor is correctly set.

## **B) SETTING UP C-MODE (THE SENSOR OPENS WHEN SUBMERGED IN THE REQUIRED MEDIUM)**

1. Immerse the sensor electrode in the medium to be measured.
2. Apply the magnetic pen for **at least 10 seconds** to the OFF sensitive spot  of the sensor (at first both LEDs are illuminated. After approx. 3 seconds, the orange LED flashes 3 times. After another approx. 2 seconds the orange LED flashes again 3 times, and after approx. 5 seconds the orange LED flashes 3 times again. You can now remove the magnetic pen).  
The sensor is now set to C-mode (opens when submerged in the required medium).
3. Check the status of the indicators:
  - If the orange LED is not illuminated and the green LED is flashing, the sensor is correctly set.

## **8.2. SETTINGS RFLS-28\_-\_-PD-\_ USING THE SSU-1212-AD UNIT**



Setting using the programming wire can be performed even after the installation of the RFLS-28 sensor with the TN-28 extension tube in the tank.

With the variant provided with the remote parametrisation option (RFLS-28\_-\_-PD-\_), it is possible to set the sensor using the programming wire and/or the special SSU-1212-AD evaluation unit. This unit is equipped with a contact (terminal No. 7) to connect the programming wire allowing all setting options of the sensor to be performed. This concerns the quick settings as per paragraph 8.1.1., the basic settings as per paragraph 9.4, and setting “medium window” mode as per paragraph 8.1.3.

### **8.2.1. THE SSU-1212-AD EVALUATION UNIT**

The unit has one input for the connection of the operating sensor (marked as IN, terminal No. 3). The operating sensor enables the control of the operating relay (terminals 14, 15, 16). The unit is fitted with a diagnostic function monitoring the correct operation of the connected sensor, and the remote parametrisation function for the connected sensor using the W programming wire. The programming wire is connected to the terminal marked P (terminal No. 7).

### **8.2.2. QUICK SETTINGS – WITHOUT THE MEDIUM PRESENT**

This mode is only suitable for verifying the sensor before commissioning if the measured medium is not available.

#### **A) SETTING O-MODE (CLOSES WHEN SUBMERGED)**

1. The sensor is turned with the measuring electrode into the free space.
2. Switch the SET CH switch to the ON position and the SET switch to the OFF position
3. Press the SETTING button for 5–10 seconds. The setting is confirmed in the following manner. After approximately 3 seconds, the orange LED flashes three times. After another approximately 2 seconds, the orange LED flashes three times again. Now, release the SETTING button. The sensor is now set to O-mode (closes when submerged).
4. Check the status of the ALARM indicator. If the red LED is not flashing, the sensor is set correctly. If it is flashing, the sensor is set incorrectly. Repeat the setting.
5. Switch the SET CH switch to the OFF position.

## **B) SETTING C-MODE (OPENS WHEN SUBMERGED)**

1. The sensor is turned with the measuring electrode into the free space.
2. Switch the SET CH and SET switches to the ON position
3. Press the SETTING button for 5–10 seconds. The setting is confirmed in the following manner. After approximately 3 seconds, the orange LED flashes three times. After another approximately 2 seconds, the orange LED flashes three times again. Now it is possible to release the SETTING button. The sensor is now set to C-mode (closes when submerged in the required medium).
4. Check the status of the ALARM indicator. If the red LED is not flashing, the sensor is set correctly. If it is flashing, the sensor is set incorrectly. Repeat the setting.
5. Switch the SET CH switch to the OFF position.

### **8.2.3. BASIC SETTING – WITH THE MEDIUM PRESENT**

A function suitable for setting the sensor to simple sensing or resolution of the interface of two media. For setting the sensitivity and switching mode, where it is possible to submerge the sensor in or remove it from the medium. When using this setting, the sensor eliminates the presence of deposits and foam on the electrode.

## **A) SETTING "O-MODE" (CLOSES WHEN SUBMERGED)**

1. Immerse the sensor electrode in the medium to be measured (in the case of the detection of a two-media interface, place the electrode in the lower medium).
2. Switch the SET CH and SET switches to the ON position.
3. Press the SETTING button for approx. 2 seconds. The setting is confirmed by three flashes of the orange LED.
4. Take the sensor out of the medium (in the case of the detection of a two-media interface, place the electrode in the upper medium). Leave any deposits on the electrode.
5. Switch the SET switch to the OFF position.
6. Press the SETTING button for approx. 2 seconds. The setting is confirmed by three flashes of the orange LED.
7. Check the status of the ALARM indicator. If the red LED is not flashing, the sensor is set correctly. If it is flashing, the sensor is set incorrectly. Repeat the setting.
8. Switch the SET CH switch to the OFF position.

## B) SETTING "C-MODE" (OPENS WHEN SUBMERGED)

1. Immerse the sensor electrode in the medium to be measured (in the case of the detection of a two-media interface, place the electrode in the lower medium).
2. Switch the SET CH switch to the ON position and the SET switch to the OFF position.
3. Press the SETTING button for approx. 2 seconds. The setting is confirmed by three flashes of the orange LED.
4. Take the sensor out of the medium (in the case of the detection of a two-media interface, place the electrode in the upper medium). Leave any deposits on the electrode.
5. Switch the SET switch to the ON position.
6. Press the SETTING button for approx. 2 seconds. The setting is confirmed by three flashes of the orange LED.
7. Check the status of the ALARM indicator. If the red LED is not flashing, the sensor is set correctly. If it is flashing, the sensor is set incorrectly. Repeat the setting.
8. Switch the SET CH switch to the OFF position.

## 8.3. SETTINGS "MEDIUM WINDOW" MODE – MEDIA RESOLUTION FUNCTION

The sensor can be used to distinguish a specific medium from others. E.g. the sensor can distinguish oil from water and air, detect only beer foam and ignore beer and air, etc. With this mode, the sensor does not react to being submerged in a medium with a different permittivity.

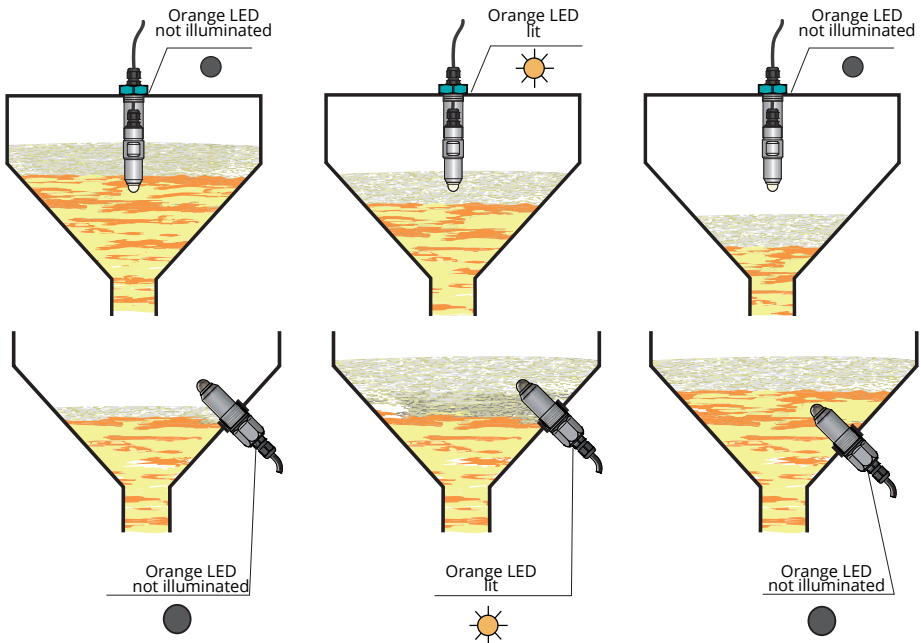

Fig. 6: "Medium window" mode – only detection of the required medium:  
(e.g.: only beer foam, beer and air are ignored)



#### **A) SETTING O-MODE (THE SENSOR CLOSES WHEN SUBMERGED IN THE REQUIRED MEDIUM)**

1. Immerse the sensor electrode in the medium to be measured.
2. Switch the SET H and SET switches to the ON position
3. Press the SETTING button for at least 10 seconds. The setting is confirmed in the following manner. After approximately 3 seconds, the orange LED flashes three times. After another approximately 2 seconds, the orange LED flashes three times again and after another approximately 5 seconds, the orange LED flashes three times again. This time, it is possible to open the SETTING button. The sensor is now set to O-mode (closes when submerged in the required medium).
4. Check the status of the ALARM indicator. If the red LED is not flashing, the sensor is set correctly. If it is flashing, the sensor is set incorrectly. Repeat the setting.
5. Switch the SET CH switch to the OFF position.

#### **B) SETTING C-MODE (THE SENSOR OPENS WHEN SUBMERGED IN THE REQUIRED MEDIUM)**

1. Immerse the sensor electrode in the medium to be measured.
2. Switch the SET CH switch to the ON position and the SET switch to the OFF position
3. Press the SETTING button for at least 10 seconds. The setting is confirmed in the following manner. After approximately 3 seconds, the orange LED flashes three times. After another approximately 2 seconds, the orange LED flashes three times again and after another approximately 5 seconds, the orange LED flashes three times again. This time, it is possible to open the SETTING button. The sensor is now set to O-mode (closes when submerged in the required medium).
4. Check the status of the ALARM indicator. If the red LED is not flashing, the sensor is set correctly. If it is flashing, the sensor is set incorrectly. Repeat the setting.
5. Switch the SET CH switch to the OFF position.

## 9. MECHANICAL MOUNTING

The **RF or RN variant** of the RFLS-28 level sensor is designed for vertical installation in tanks and reservoirs.

With the TN-28 extension tube, which is available in three process connection variants (flange, G1" thread, or Tri-Clamp), it can be extended to the required length.

### Installation instructions:

- With the RFLS-28N-RG\_- P - \_ variant with no option of remote parametrisation, set-up needs to be performed before the sensor is installed in the tank, because setting is unavailable after installation in the tank.
- If the sensor is set up, you can proceed to installation in the TN-28 extension tube. It consists of a tube (with identical threads on both ends) and the process connection (flanged, threaded, or Tri-Clamp).
- First, pull the sensor cable through the tube, then through the process connection with the respective cable gland (do not dismount the cable gland from the process connection of the extension tube, only loosen or remove its nut).
- Then screw the RFLS-28 sensor and the process connection into the tube and retighten the cable gland nut (make sure not to restrict the free rotational movement of the sensor by the cable gland when screwing the sensor into the tube). For longer tubes, it is recommended to use glue for threaded joints.
- The complete assembly with the selected process connection is attached to the tank.

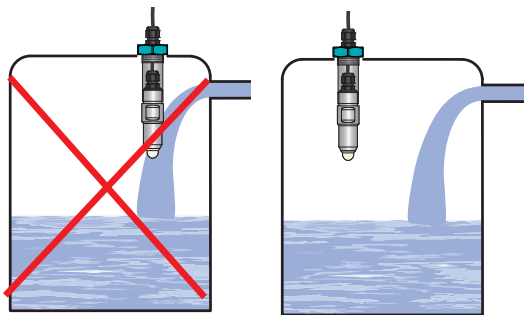

Fig. 7a: Installation of the level meter out of reach of the filling flow

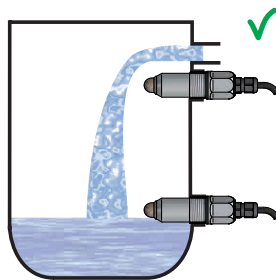

Fig. 7b: Possibility of sensor installation in the media inlet point



When installing the sensor in a metal tank or reservoir, it is not necessary to earth the housing separately.



If the sensor is used for an aggressive medium, it is necessary to check the chemical compatibility of the materials the sensor is made of (see tab. materials used on p. 18). Chemical damage is not covered by the warranty.



In the case of placement in the tank at the medium inlet point, installation out of reach of the filling flow is required

The **FG and FN variants** of the RFLS-35 sensor can be installed either horizontally or at an angle on the wall of the vessel, reservoir, or pipe by screwing into a weld nut or by fixing using a nut. The basic application recommendations are specified below.



When installing the sensor in a metal tank or reservoir, it is not necessary to earth the housing separately.



If the sensor is used for an aggressive medium, it is necessary to check the chemical compatibility of the materials the sensor is made of (see tab. materials used on p. 21). Chemical damage is not covered by the warranty.

Thanks to its construction, the sensor is also suitable for detecting levels of **viscous and electrically conductive media** (yoghurt, jams, mayonnaise, spreads, liquid soaps, creams, and pastes). After setting the sensitivity to the given medium, the sensor reliably reacts to the presence or absence of the medium level. Conversely, the sensor does not react to residues and deposits of viscous media on the measuring electrode.

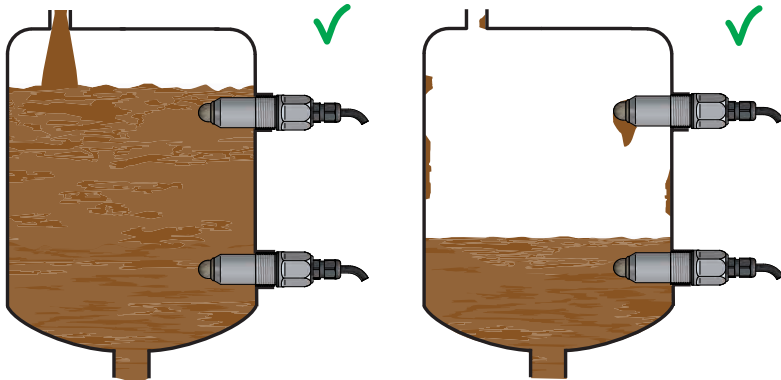

Fig. 8: Side installation of sensors in a tank filled with viscous medium

It is recommended to install the sensors in a horizontal pipe **at an angle**.

In the case of vertical installation of the sensor in a pipe, make sure no air pockets form

and no liquid residues adhere to the bottom of the pipe.

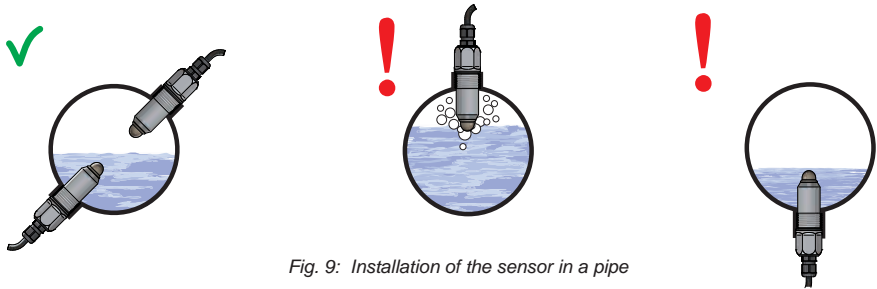

Fig. 9: Installation of the sensor in a pipe

In the case of **installation on the side wall**, long extension pipes with potential adherence of viscous media must not be used. We recommend installing the sensor with the entire measuring electrode inside the vessel.

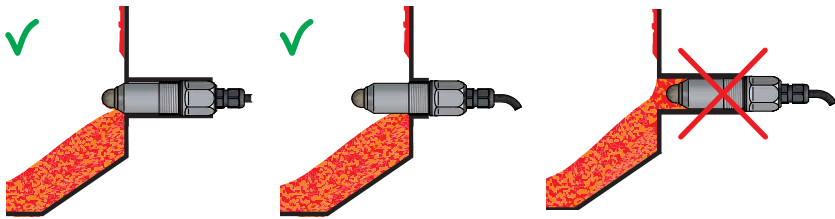

Fig. 10: Correct and incorrect installation with a long extension pipe

Installation of the sensor for reliable inspection of the level of liquids with foam on the surface. The sensor sensitivity can be based on detection of an interface between liquid and foam. If the level drops, the sensor does not react to foam deposits on the electrode.

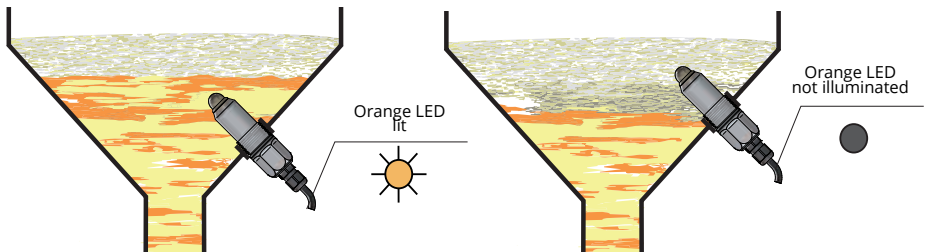

Fig. 11: Monitoring the level of a foamy medium

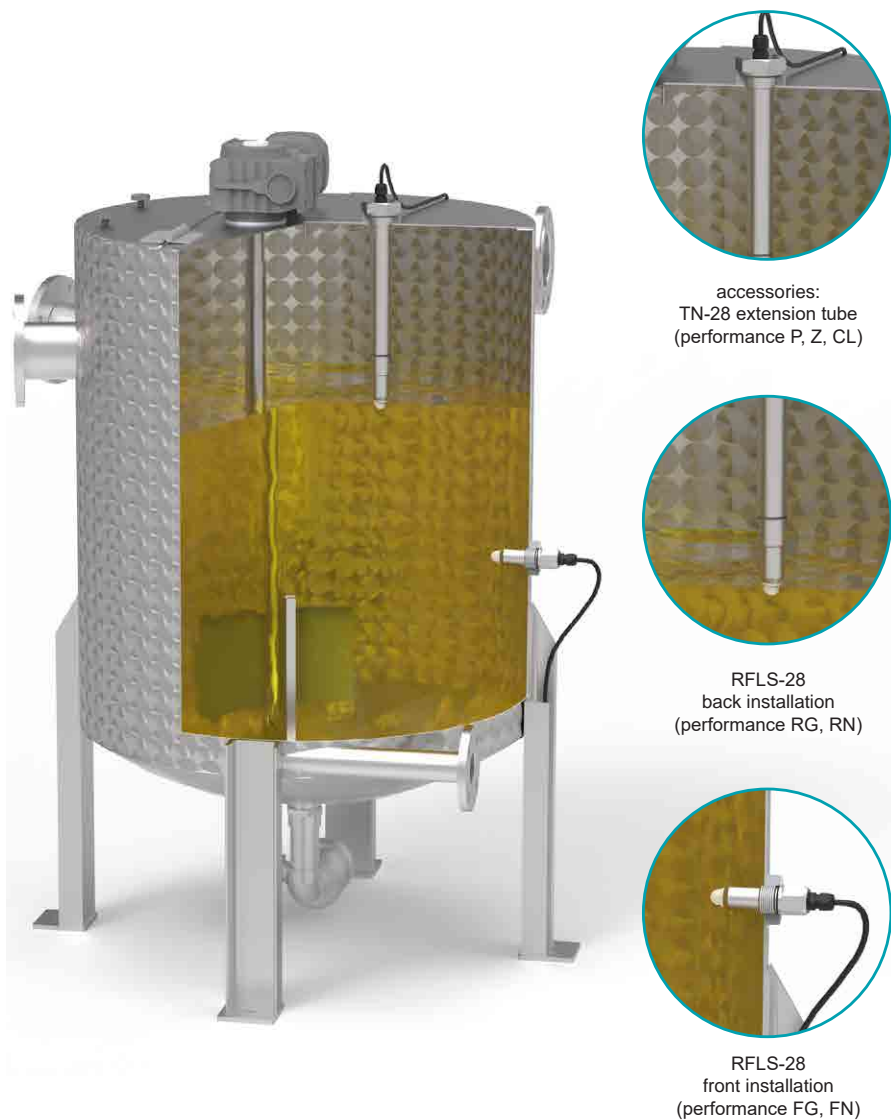

Fig. 12: Examples of the installation of the sensors in a tank

## 10. SENSOR VARIANT WITH THE “PD” OUTPUT WITH DIAGNOSTICS<sup>1)</sup>

---

The RFLS-28\_ \_ \_-PD-\_ sensor type has built-in diagnostics, which can be used to monitor the sensor's internal integrity.

The SSU-1212-D(AD) evaluation unit is used for the evaluation of diagnostic modes. This unit is able to evaluate diagnostic pulses generated by the sensor. It does not matter what the sensor output status is (closed or open). Based on the evaluation of generated pulses, the unit determines which mode the sensor is in and communicates the information to the user.

If the sensor is set up incorrectly or fails, an appropriate alarm is activated and the red indicator LED starts flashing (in the case of incorrect setting) or illuminates (in the case of a failure). The emergency relay opens (terminal Nos. 11 and 12). When the setting is corrected or the failure is removed, the alarm is deactivated and the unit proceeds to standard operation.

# 11. ORDER CODE

ORDER CODE											
RFLS-28											
<b>PERFORMANCE</b>											
<b>N</b> non-explosive areas											
<b>ELECTRODE TYPE</b>											
<b>1B</b> insulated electrode (PEEK, NBR O-ring)											
<b>10B</b> insulated electrode (PEEK, NBR O-ring) with protective crown											
<b>1E</b> insulated electrode (PEEK, EPDM O-ring)											
<b>10E</b> insulated electrode (PEEK, EPDM O-ring) with protective crown											
<b>1V</b> insulated electrode (PEEK, FPM (Viton) O-ring)											
<b>10V</b> insulated electrode (PEEK, FPM (Viton) O-ring) with protective crown											
<b>PROCESS CONNECTION</b>											
<b>FG</b> front installation, thread G 3/4", unavailable for 10B, 10E, and 10V type electrodes											
<b>RG</b> back installation, thread G 3/4"											
<b>FN</b> front installation, NPT 3/4", unavailable for the 10B, 10E, and 10V type electrodes											
<b>RN</b> back installation, NPT 3/4"											
<b>OUTPUT OF TYPE</b>											
<b>P</b> PNP (open collector), setting using a magnetic pen											
<b>PD</b> PNP (open collector) with diagnostic <sup>1)</sup> setting using a magnetic pen or programming wire											
<b>TYPE OF ELECTRICAL CONNECTION</b>											
<b>B</b> standard plastic cable gland (compatible with TN-28)											
<b>V</b> plastic cable gland with spiral relief, cannot be used for TN-28											
<b>H</b> plastic cable gland for protective hose, cannot be used for TN-28											
<b>CABLE</b>											
<b>K</b> cable length in m											
RFLS-28	N	-	1B	-	FG	-	P	-	B	K 5	<b>AVAILABLE VARIANT OF THE PRODUCT CODE</b>

<sup>1)</sup> The SSU-1212-D, SSU-1212-AD evaluation units are used to evaluate the diagnostic signal.

## 12. ACCESSORIES

magnetic pen (1 unit)	included in the price	MP-8	
O-ring (NBR, EPDM, FPM/Viton), (1 unit)	included in the price		
extension tube	at extra cost	TN-28-P (flange) TN-28-Z (G1" thread) TN-28-Cl (Tri-Clamp)	
cable over 2 m	at extra cost		
protective hose (for cable gland H)	at extra cost		



## 13. RESILIENCE OF O-RINGS

RESILIENCE OF INDIVIDUAL TYPES OF O-RINGS TO VARIOUS MEDIA			
Medium	V (FPM)	E (EPDM)	B (NBR)
Temperature limitations	-25 ... 200 °C	-40 ... 140 °C	-30 ... 100 °C
Water up to 80 °C	••	••	••
Water up to 135 °C	–	••	–
Chlorinated water	•• (up to 80 °C)	•	–
Seawater	• (up to 80 °C)	••	••
Supply water for boilers	• (up to 80 °C)	••	•
Water vapour up to 150 °C	–	••	–
Water vapour above 150 °C	–	•	–
Oil/water emulsion	• (up to 80 °C)	–	••
Demineralised water/deionized water up to 100 °C	•• (up to 80 °C)	•	•
Distilled water	• (up to 80 °C)	••	•
Alcohol (methanol, ethanol)	–	••	••
Acetone, chloroacetone	–	••	–
Ammonia	–	••	•
Isocyanate	–	••	–
Asphalt	••	–	–
Tar	•	–	–
Chlorine	••	•	–
Toluene, TNT	•	–	–
Octanes	–	••	–
Nitration mixtures	–	••	–
Brake fluids based on glycol	–	••	–
Brake fluids based on mineral oils	••	–	••
Lyes	–	••	•
Hydrogen peroxide	••	–	–
Acetic acid	–	••	–
Formic acid	–	•	–
Oils, kerosene	••	–	••
Petrol, motor diesel, petroleum	••	–	••
Petrol + ethanol	•	–	•
Crude oil	••	–	•
Refrigerant fluids based on ethylene glycol	••	••	••
Acids in general*	•	•	–
Alkalis in general*	•	••	•
Ozone	••	••	–

\* The type of O-ring for a specific type of medium must be discussed with the manufacturer.

### Legend:

- suitable
- conditionally suitable
- unsuitable

## 14. SAFETY, PROTECTION, AND COMPATIBILITY

---

The level sensor is equipped with protection against electric shock on the electrode, reverse polarity, output current overload, short circuit, and against current overload on output.

Protection against dangerous contact is provided by low safety voltage according to ČSN 33 2000-4-41. Electromagnetic compatibility is provided by conformity with standards ČSN EN 55011/B, ČSN EN 61326-1, ČSN EN 61000-4-2 to -6 and -8.

A declaration of conformity was issued for this device in the wording of Act No. 90/2016 Coll., as amended. Supplied electrical equipment matches the requirements of valid European directives for safety and electromagnetic compatibility.

## 15. FUNCTIONAL SAFETY

---

The RFLS-28 high-frequency level sensors meet the requirements imposed on the level of safety integrity by the series of ČSN EN 61508 standards. The sensors are designed for applications of liquid level detection with higher safety requirements:

- Mode of protection against overfilling
- Mode of protection against no-load operation

The sensors meet the requirements imposed on functional safety SIL 2 in both modes.

The sensor electronic system has 1oo1 architecture (depending on the output variant either single-channel without the P diagnostic, or single-channel with the PD diagnostic).

**It is recommended to perform a functional check of the sensor function once a year.**

## 16. USE, OPERATION, AND MAINTENANCE

---

The level meter does not require any personnel to run. Maintenance of this equipment consists in verification of the integrity of the level meter and of the supply cable. Cleaning or sterilisation of the sensor (CIP/SIP) is possible under the conditions specified in the technical specifications.



**It is forbidden to make any changes to or interventions in the RFLS-28 sensor without the consent of the manufacturer. Any repairs must only be carried out by the manufacturer or authorised service organisations.**

**Assembly, installation, commissioning, service, and maintenance of the RFLS-28 level sensor must be carried out in accordance with this manual, and the provisions of valid standards for the installation of electrical equipment must be complied with.**

**Activity during the operation:**

- If the sensor is connected to the automatic control system or to emergency indication, it must not be infringed in its setting during the operation.
- If a change of the sensor settings is necessary, the whole system must be temporarily switched off and the process held in a safe condition using other means and measures.
- Fault indication is described in the following chapters *Status indication or Status indication of the sensor with diagnostic*

### **Activity in the case of a failure**

- In the event of detected faults or fault signals, the whole system must be shut down and the process held in a safe condition using other means and measures.
- If the sensor must be replaced due to a fault, it is necessary to notify the manufacturer (including a description of the fault).

### **Repairs of the sensors:**

If you need to send the sensor for repair, proceed as follows:

- Remove and clean the sensor or decontaminate it and wrap it well.
- Write as detailed a description of the fault as possible. Attach a detailed description of the application and of the installation location and send everything together with the sensor to the Dinel s.r.o. company address.
- We would like to ask for your utmost cooperation in finding the root cause of the fault. Your satisfaction is our top priority!

## **17. PUTTING OUT OF OPERATION OR DISPOSAL**

---

### **Disassembly:**

Before starting disassembling, take into account possible risks, such as pressure in the tank, high temperatures, corrosive properties, or product toxicity, etc.

Read the product use instructions in the chapters “Instructions for installation” and “Electrical connection” and perform the specified steps in reverse order.

### **Disposal:**

The RFLS-28 capacitive limit sensors are made of materials that can be recycled by specialist providers. Mark the device as waste and dispose of it in accordance with the applicable legal regulation for electronic waste disposal. For the materials, see the “Technical specifications”.

## **18. GENERAL CONDITIONS AND WARRANTY**

---

The manufacturer guarantees from the supply that this product will have the established properties given in the technical conditions for a period of 3 years.

The manufacturer is responsible for faults that are identified during the warranty period and are claimed in writing.

The warranty does not apply to defects resulting from improper handling or failure to comply with the technical specifications.

The warranty shall expire if the customer or a third party carries out changes or modifications to the product, if the product is mechanically or chemically damaged, or if the production number is not legible.

For the application of a claim, it is necessary to submit the certificate of warranty.

In the event of a justified complaint, we will repair the defective product, or replace it with a new one. In both cases, the warranty period shall be extended by the time of the repair.

## 19. PRODUCT MARKING

Marking is performed by laser etching on the sensor body  
Data on the sensor of series **RFLS-28N-1\_\_-R\_-P\_-**

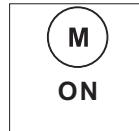
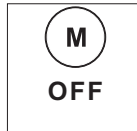
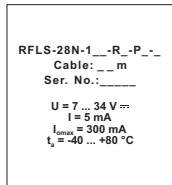

Data on the sensor of series **RFLS-28N-1E-FN-P-B**

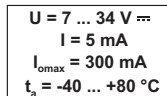
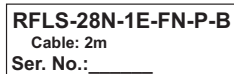

### Description:

Symbol of the manufacturer: Dinel<sup>®</sup> logo

Internet address: [www.dinel.cz](http://www.dinel.cz)

Country of origin: Made in Czech Republic

Level meter type: RFLS-28N-\_\_-P-\_\_

Cable length: Cable: \_\_ m

Serial number of the product: No.: \_\_\_\_\_ - (from the left: production year, serial production number)

Supply voltage: U = 7 ... 34 V =

Supply current: I = 5 mA

Maximum output current: I<sub>omax</sub> = 300 mA

Ambient temperature range: t<sub>a</sub> = -40 ... +80 °C

Protection class: IP68

Compliance mark: CE

Electro-waste take-back system mark:

## 20. TECHNICAL PARAMETERS

### BASIC TECHNICAL SPECIFICATIONS

Supply voltage	7 ... 34 V DC	
Power consumption	max. 5 mA DC	
Max. switching current (PNP output)	300 mA	
Residual voltage - ON status	max. 1.5 V	
Coupling capacity (housing – power)/dielectric strength	5 nF/500 V AC (50 Hz)	
Protection class	IP68	
Cable (versions with a cable gland)	PVC 3 x 0.5 mm <sup>2</sup>	
Weight (without cable)	approx. 0.15 kg	
Minimum relative permittivity	$\epsilon_r = 1.5$	
Minimum distance of the electrode from the vessel wall	type el. 1	20 mm
	type el. 10	10 mm

### MATERIALS

part of the sensor		standard material *
Housing (case)		stainless steel W.Nr. 1.4404 (AISI 316L)
Enclosure		polycarbonate
Electrode coating	type el. 1, 10	PEEK
O-ring seal	RFLS-28_-1B, 10B RFLS-28_-1E, 10E RFLS-28_-1V, 10V	NBR EPDM FPM (Viton)
Cable gland ("B", "V", "H" versions)		PA/NBR plastics

Verify chemical compatibility with the media. Upon agreement, it is possible to select a different type of material.

### PROCESS CONNECTION

name	dimension	marking
Pipe thread	G 3/4"	FG, RG
NPT thread	NPT 3/4	FN, RN

### MECHANICAL PERFORMANCE AND AREA CLASSIFICATION

Sensor performance	electrode type	Device classification
RFLS-28N	All types	Basic performance for use in non-explosive environments.

### FACTORY DEFAULT

switching mode	O (closes when submerged)
sensitivity	for sensing water

FUNCTIONAL SAFETY PARAMETERS		
sensor variants	RFLS-28N-_-_-P-_-	RFLS-28N-_-_-PD-_-
According to standard	ČSN EN 61508 ed.2	
Safety functions	MIN, MAX	
Category	SIL2	
Hardware architecture	1oo1 without diagnostic	1oo1 with diagnostic
DC	0%	99%
PFH ( $T_{Proof} = 1$ year)	$1.471 * 10^{-7}$	$1.471 * 10^{-9}$
$\lambda_{DD}$	0 FIT	145.6 FIT
$\lambda_{DU}$	147.1 FIT	1.5 FIT
MTTF <sub>D</sub>	776 years	

Legend:

SIL

Safety integrity level,

DC

Diagnostic cover,

PFH

Probability of failure per hour

$T_{Proof}$

Frequency of the functional check of the instrument safety function

$\lambda_{DD(DU)}$

Detectable (or undetectable, where applicable) dangerous failure rate

MTTF<sub>D</sub>

Mean time to dangerous failure

TEMPERATURE AND PRESSURE DURABILITY – N performance			
performance variant	temperature tp	temperature ta	maximum overpressure
RFLS-28N-1B(1E, 10B, 10E)-RG(RN)	-40 °C ... +105 °C	-40 °C ... +105 °C	10 MPa
RFLS-28N-1V (10V)-RG(RN)	-20 °C ... +105 °C	-20 °C ... +105 °C	10 MPa
RFLS-28N-1B (1E)-FG(FN)	-40 °C ... +105 °C	-40 °C ... +80 °C	10 MPa
RFLS-28N-1V-FG(FN)	-20 °C ... +105 °C	-20 °C ... +80 °C	10 MPa

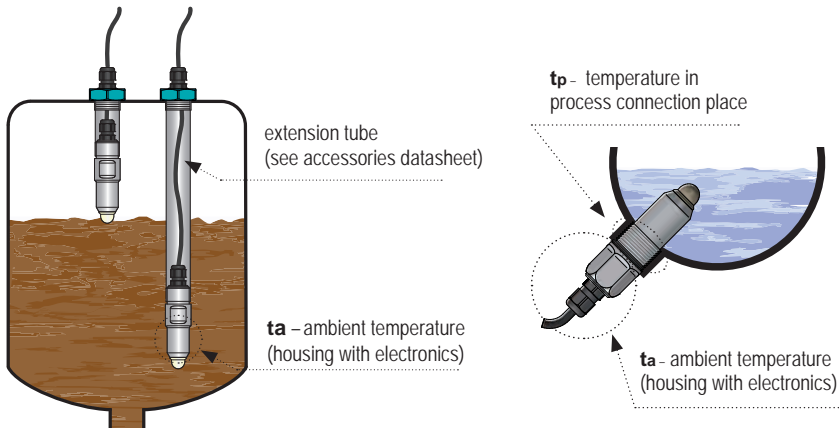

## 21. PACKING, SHIPPING, AND STORAGE

---

The RFLS-28 device is packaged in a polyethylene bag, and the entire consignment is placed in a cardboard box. A suitable filler material is used in the cardboard box to prevent mechanical damage during transport.

Only remove the device from the packaging just before using, thereby protecting it from potential damage.

A forwarding company will be used to ship the goods to the customer. Upon prior agreement, ordered goods can be picked up in person from the company headquarters. When receiving, please check to see that the consignment is complete and matches the order, or to see if any damage has occurred to the packaging and device during transport. Do not use a device clearly damaged during transport, but contact the manufacturer in order to resolve the situation.

If the device is to be further shipped, it must be wrapped in its original packaging and protected against impact and weather conditions.

Store the device in its original packaging in dry areas protected from weather conditions, with humidity of up to 85 % without any effects of chemically active substances. The storage temperature range is -10 °C to +50 °C.

# Dinel<sup>®</sup>

industrial electronics

**Dinel, s.r.o.**  
U Tescomy 249  
760 01 Zlín  
Czech Republic

Phone: +420 577 002 002  
E-mail: sale@dinel.cz

[www.dinel.cz](http://www.dinel.cz)

*The manufacturer reserves the right to change the specifications and appearance of the product without prior notice*

*Find the updated version at [www.dinel.cz](http://www.dinel.cz)*

*version: 10/2022*

