



RADAR LEVEL METERS WITH GUIDED WAVE GRLM-70



CONTENTS

1. Basic description	4
2. Range of application	4
3. Variants of sensors	5
4. Dimensional drawings	6
5. Installation and putting into operation	7
6. Mechanical mounting	8
7. Electrical connection	17
8. Setting elements	19
9. Settings	20
9.1. Basic settings	20
9.2. Service settings	23
9.3. Additional functions	25
10. HART® communication protocol	28
11. Protocol Modbus®	29
12. The installation of the custom measuring electrode, exchange or shortening of the electrode	30
13. Function and status indication	32
14. Order code	32
15. Correct specification examples	33
16. Accessories	33
17. Safety, protection, compatibility and explosion proof	33
18. Use, manipulation and maintenance	34
19. General conditions and warranty	34
20. Marking of labels	35
21. Technical specifications	36
22. Packing, shipping and storage	42
23. Menu structure	43

USED SYMBOLS

To ensure maximum safety of control processes, we have defined the following safety instructions and information. Each instruction is labelled with the appropriate pictogram.



Alert, warning, danger

This symbol informs you about particularly important instructions for installation and operation of equipment or dangerous situations that may occur during the installation and operation. Not observing these instructions may cause disturbance, damage or destruction of equipment or may cause injury.



Information

This symbol indicates particularly important characteristics of the device.



Note

This symbol indicates helpful additional information.

SAFETY



All operations described in this instruction manual have to be carried out by trained personnel or by an accredited person only. Warranty and post warranty service must be exclusively carried out by the manufacturer.

Improper use, installation or set-up of the sensor can lead to crashes in the application.

The manufacturer is not responsible for improper use, loss of work caused by either direct or indirect damage, and for expenses incurred at the time of installation or during the period of use of the level sensors.

1. BASIC DESCRIPTION

The GRLM® radar level meters are compact measuring devices consisting of three main parts - measuring electrodes, housing with the computing electronics (head) and a display module (screen). The electronic transmits very short electrical pulses (0.5 ns), which is connected with a one-wire transmission line (measuring electrode). Measuring electrode can be formed from rod or rope. The pulse propagates along the electrode in the form of electromagnetic wave toward the level part of electromagnetic wave, where it is partly reflected and the reflected returned to the receiving module of the electronic. The electronic measures the time of flight of electromagnetic wave and the current (actual) distance to the level is calculated. Then based on the height of the level, the level meter current output 4 ... 20 mA is set with the HART communications or an industrial RS-485 line with Modbus RTU communications and the measured value is shown on the display.

2. RANGE OF APPLICATION

Radar level meters with guided wave are suited to continuous level measurement of various liquid, mush and bulk-solid materials. Level meters are resistant against changes in the atmosphere (pressure, temperature, dust, steam) and to changes in medium parameters (change in dielectric constant, conductivity).

3. VARIANTS OF SENSORS

- **GRLM-70_-00** **Without electrode**, the electrode is made by customer (only variant 10 or 30) and connected to the electrode junction by M8 thread.
- **GRLM-70_-10** **Uncoated stainless steel rod electrode**, for level measurement liquids and bulk solid materials (water solutions, emulsion, oils, diesel, flour, sand, granulates, etc.). Electrode length 0,5 ... 8 m.
- **GRLM-70_-11** **Fully coated stainless steel rod electrode (PFA)**, for level measurement of aggressive liquids and very pure liquids. Electrode length 0,5 ... 2 m.
- **GRLM-70_-12** **Fully coated stainless steel rod electrode (FEP)**, for level measurement of aggressive liquids and drinks. Electrode length 0,5 ... 2 m.
- **GRLM-70_-13** **Semi-coated stainless steel rod electrode (FEP)**, for level measurement of liquids in area, where it could condense steam on the electrode. Electrode length 0,5 ... 8 m.
- **GRLM-70_-20** **Uncoated stainless steel rod electrode with reference tube (coaxial)**, for accurate level measurement of liquids in cramped spaces. Electrode length 0,5 ... 3 m.
- **GRLM-70_-30** **Uncoated stainless steel rope electrode and weight**, for level measurement of liquids and bulk solid materials (water, grains, sand, flour, cement, etc.) in higher silos, vessels, reservoirs. Electrode length 1 ... 40 m.
- **GRLM-70_-32** **Fully coated stainless steel rope electrode (FEP) and coated weight (PTFE)**, for level measurement of aggressive liquids and very pure liquids. Electrode length 1 ... 12 m.
- **GRLM-70_-33** **Uncoated stainless steel rope electrode with anchorage**, for level measurement of bulk solid materials (grains, flour, cement, etc.) in higher silos, vessels. Electrode length 1 ... 40 m.
- **GRLM-70_-34** **Coated stainless steel rope electrode (Polyamide) and uncoated weight**, for level measurement of liquids and adhesive bulk solids (flour, cement, etc.). Electrode length 1 ... 40 m.
- **GRLM-70_-35** **Coated stainless steel rope electrode (Polyamide) with uncoated anchorage**, for level measurement of adhesive bulk solids (flour, cement, etc.). Electrode length 1 ... 40 m.

4. DIMENSIONAL DRAWINGS

GRLM-70_-00

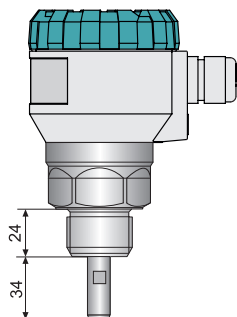

GRLM-70_-10

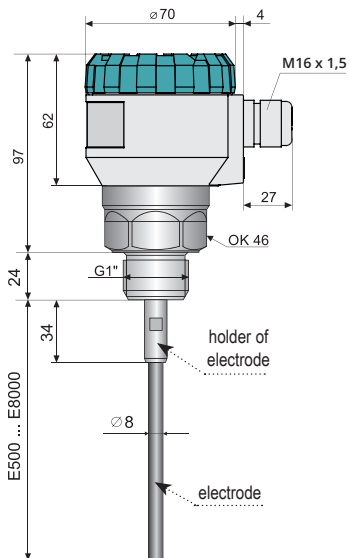

GRLM-70_-11(12)

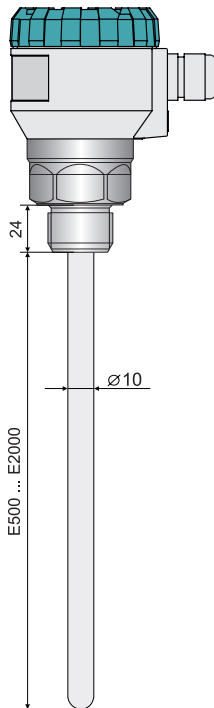

GRLM-70_-13

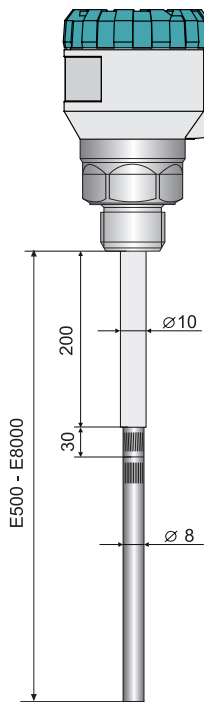

GRLM-70_-20

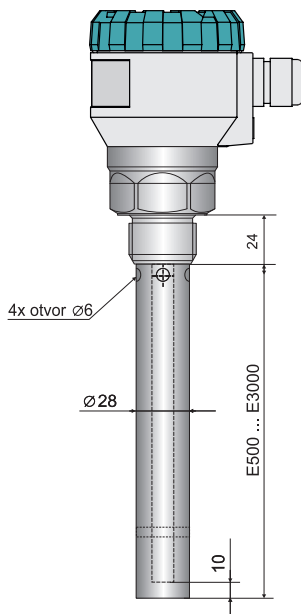

Procesní připojení
Tri-clamp

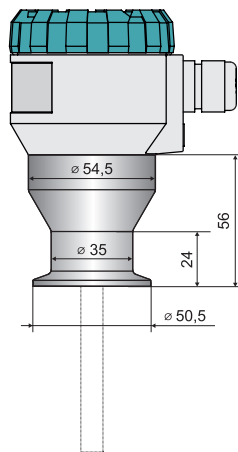

6. MECHANICAL MOUNTING

BASIC INFORMATIONS

VALID FOR: all types

- Install the level meter into the upper lid of the tank or reservoir using a welding flange or fastening nut.
- The min. distance to install the level meter into a lid or a ceiling of a tank from the tank wall or bottom is given in table below.
- Otherwise, the level meter install as far as possible from the walls, to the middle between the wall and the vertical inlet, see Fig. 1. a 2.

DISTANCE TO TANK WALL

type of wall	d (without ref. tube)	d (with ref. tube)
metal	≥ 300 mm*	any distance
non-metal	≥ 500 mm*	any distance

* it is recommended that a smaller distance from a wall is consulted with the manufacturer.

DISTANCE TO BOTTOM

type of electrode	h
rod (no anchoring)	≥ 100 mm ² (length of electrode to 2 m) ≥ 150 mm ² (length of electrode over 2 m)
rope (no anchoring)	≥ 100 mm (length of electrode to 10 000 mm) ≥ 150 mm (length of electrode over 10 000 mm)

²⁾ In case of a sloping bottom the distance "h" should be twice as long.

E – The length electrode
t – Maximum measuring range
m – Dead zone on the beginning of electrode
k – Dead zone on the end of electrode or the length of weight (110 mm) at the rope
d – The distance from the tank wall (see. Tab. above)
h – The distance from the bottom (see. Tab. above)

$$E = m + t + k$$

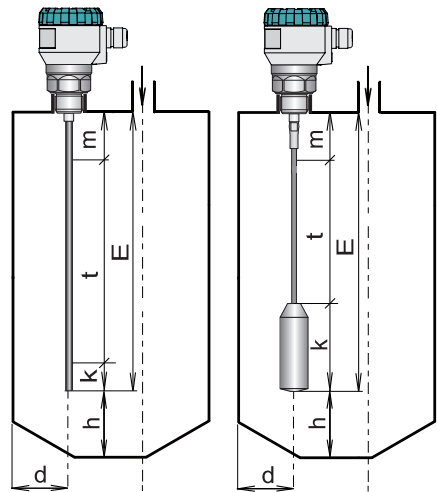

Fig. 1: Level meter installation with the rod electrode

Fig. 2: Level meter installation with the rope electrode

MEASURING RANGE

VALID FOR: all types

- This is an area in which the continual measurement of the level is being performed. The maximum measuring range is determined by the length of the measuring electrode with subtraction of the dead zones at the beginning and end of the electrode, see fig. 1 and 2. This range is also the default setting of the level meter. The maximum measuring range can be reduced by the user by changing the minimum and maximum level in the case of obstacles near of the end or particularly of the beginning of the measuring electrode.
- In the event that the measured level is outside the measuring range, the level meter (for the current version I) will go into failure mode and the output current will have a value that is set by the user (default value for error mode is given in the Table of default settings). On Modbus version M, the relevant measurement status bits on register 104 are activated, see the GRLM-70 Modbus RTU commands.

DEAD ZONE

VALID FOR: all types

- In connection with the measurement principle, it is not possible to evaluate electromagnetic waves deflected in the area directly below the level meter and also at the end of the electrode (see fig. 3 and 4). These zones determine either the minimum distance between the level meter and the highest possible level (parameter "m"), or the minimum distance at the end of the electrode (parameter "k"). **The level meter must be installed so that when the tank is filled to the maximum and minimum possible level, the surface level is not in the dead zones.**
- The size of the dead zone is shown in FIG. 32 - 35 on pages 37, 38.

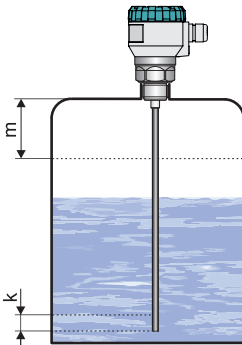

Fig. 3: Level meter dead zone with rod electrode

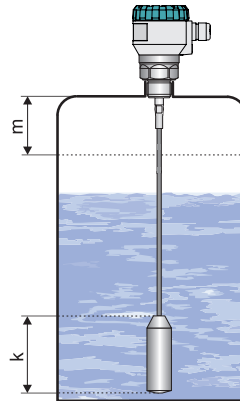

Fig. 4: Level meter dead zone with rope electrode

SIZE OF DEAD ZONE DEPENDING ON THE SELECTED MEASUREMENT SENSITIVITY

measurement sensitivity	m	k (rod electrode)	k (rope electrode)
low, medium, user (1 - 4)	100 mm	0 mm	110 mm
high, user (5)	150 mm	50 mm	110 mm
user (6, 7)	200 mm	50 mm	110 mm
user (8)	250 mm	50 mm	110 mm

INPUT NECK

VALID FOR: all types except GRLM-70_-20

- For correct measurement, it is important to avoid installing the level meter in a high input neck or high welding flange. If this is not possible, the level meter may be installed in a **short input neck**, the parameters of which are provided in fig. 5. Here it applies that the neck diameter selected should be as large as possible but the neck height should be as small as possible.

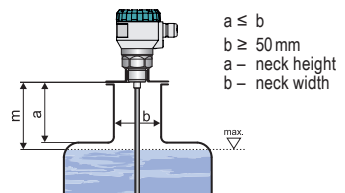

Fig. 5: Level meter installation in the input neck



When installing the level meter into an input neck, use the **TEACHING** procedure (see chapter 9.1. Basic settings). This will put the sensor into a mode that suppresses false reflections.

- The end of the socket or the welding flange must not have an extension into the tank in Fig. 6.
- Dimension restrictions of the input nozzle does not apply to the use of GRLM-70_-20 with reference tube (coaxial).

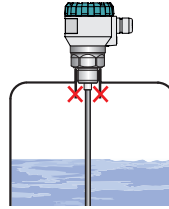

Fig. 6: Incorrect welding flange mounting to the tank

NON-METAL TANK

- To install the level meter in a non-metallic water tank, it is necessary to insert a metal plate with a diameter greater than 200 mm in the area of the process connection, see fig. 7. The metal plate must be in contact with the thread stop of the level meter.

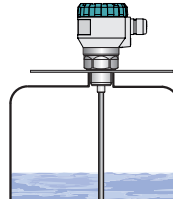

Fig. 7: Level meter installation in the non-metal tank

VALID FOR: all types except GRLM-70_-20

CONCRETE SILO

VALID FOR: GRLM-70_-30, 32, 33, 34, 35

- When installing the level meter into the roof of a concrete silo, the level meter installation hole b must be larger than the thickness of the concrete a, see fig. 8.
- In the event that the thickness of the concrete is greater than the diameter of the hole, it is necessary to install the level meter into a countersink, see fig. 9.

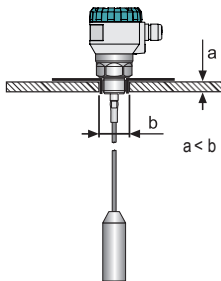

Fig. 8: Level meter installation on the roof of the concrete silo

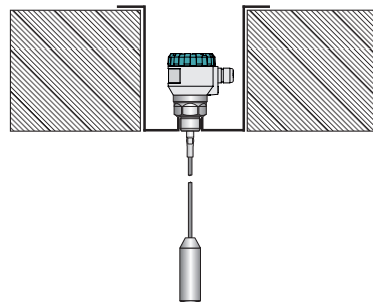

Fig. 9: Level meter installation on the roof of the concrete silo

LEVEL METER PROTECTION

VALID FOR: all types

- The level meter must not be installed in locations exposed to direct solar radiation and must be protected against the effects of weather. In the event that installation in a location with direct solar radiation is unavoidable, it is necessary to install a shielding cover above the level meter (fig. 10).

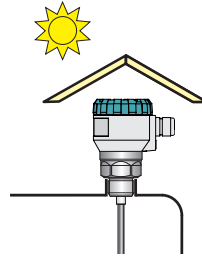

Fig. 10: Solar radiation shielding cover

OUTSIDE THE INFLUENCE OF FILLING

VALID FOR: all types

- It is not recommended to install the level meter in or above the filling location. Measurement may be affected by the medium flowing in rather than measuring the level of the material.

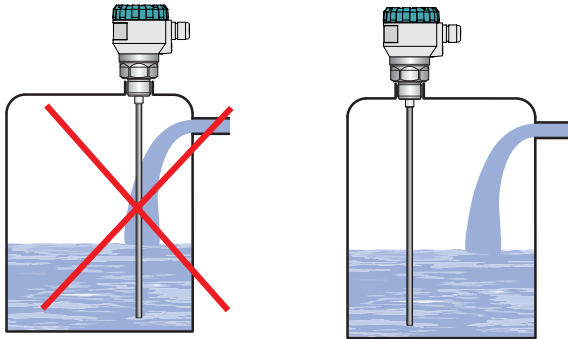

Fig. 11: Level meter installation outside the influence of filling

OBSTACLES IN THE TANK

VALID FOR: all types except GRLM-70_-20

- The level meter generates an electromagnetic guided wave, which creates an electromagnetic field along the electrode. Objects placed close to the electrode disturb the electromagnetic field and thus affect the measurement. Therefore, it is determined a protective zone along the electrode of radius 300 mm. The level meter is recommended to install the tank so that the items placed inside the tank (ladders, various partitions, mixers, etc.) do not intervene into the protective zone, see Fig. 12.

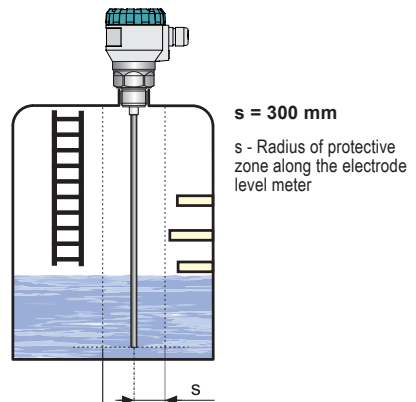

Fig. 12: Level meter installation outside obstacles in the tank

- If still these objects intervene into the protective zone of the level meter, it is necessary to create a map of false reflections by activating the "TEACHING" mode (p. 18). In case of installed mixers, it is necessary to position the mixers near the level meter (turning the mixer blade to the proximity of the electrode). Items inside the tank must not be from the electrode distance of less than 100 mm, because a interference of electromagnetic field is very strong in this zone and "TEACHING" mode can not be used.

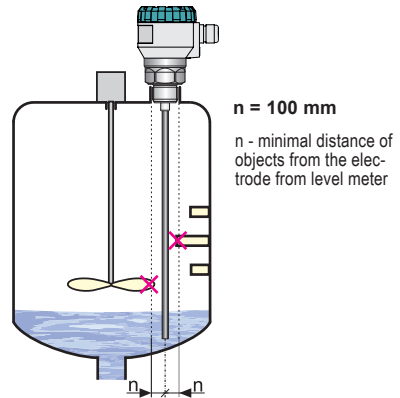

Fig. 13: Incorrect level meter installation close to obstacles

CRAMPED SPACES

VALID FOR: GRLM-70_-20

- For the type of level meter with reference tube (coaxial) electromagnetic guided wave propagates inside the reference tube. This wave is not affected by the ambient environment. So for this type of radar is not intended protective zone around the electrodes and the level meter can be used for measurements in cramped spaces.

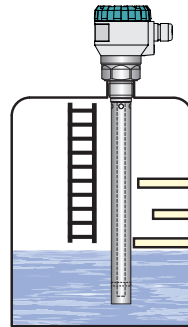

Fig. 14: Level meter installation with reference tube (coaxial) in cramped spaces

HUMIDITY

VALID FOR: all types

- It is appropriate to lead the cable underneath the cable terminal (through the dip diagonally downwards) This will prevent potential "ingression of moisture through the cable grommet. Thereby, rain and condensing water can flow away freely, fig. 15.
- The cable bushing and connector have to be sufficiently tightened to prevent penetration of humidity.

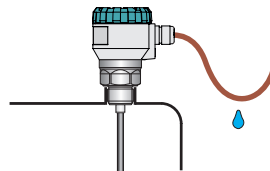

Fig. 15: Prevention to avoid intrusion of humidity through cable gland

DEEP TANKS AND SILOS

VALID FOR: GRLM-70_-30, 32, 33, 34, 35

- For installation of the level meter with rope electrode into deep tanks and silos the length of the electrode must be selected so that the weight will be below the minimum measured level, see Fig. 16.
- The distance the electrode from the tank wall must be at least 300 mm. Otherwise, the level meter install as far as possible from the walls, to the middle between the wall and the vertical inlet, see Fig. 16. It must be ensured that the rope electrode could not touch the vessel wall caused by the motion of the medium.
- Ensure that the maximum tensile load on the rope of the electrode is not exceeded. Its value is specified in chapter "Technical parameters". A large load could result in the rope tearing. The tensile load depends on the height and shape of the tank, the thickness and adhesion of the measured medium and the tank emptying speed.

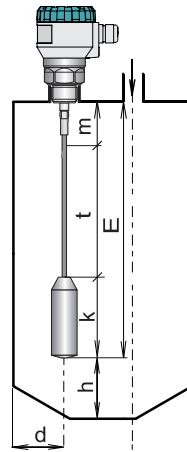

Fig. 16: Level meter installation with the rope electrode

$$E = m + t + z$$

- E – The length of rope electrode
- t – Measuring range
- m – Dead zone
- k – The length of weight (110 mm)
- d – The distance from the tank wall min. 300 mm
- h – The distance from the bottom (see. Tab. page 8)

DEPOSITS ON THE ELECTRODE

VALID FOR: all types

- Deposits, layers and sediments on the electrode may distort measurement and reduce the permeability of the electromagnetic wave propagated along the electrode.

VARIANT WITHOUT ELECTRODE

VALID FOR: GRLM-70_-00

- Type of level meter without electrode is supplied without an electrode. It is therefore necessary to a customer to mount his own made measuring electrode. The diameter of the electrode must be between 8-10 mm. For a connection it is necessary that on the electrode is made M8 thread. The connection procedure is given in Sec. 12 page. 30.

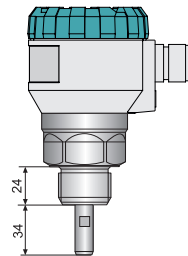

Fig. 17: Level meter without electrode



For the type of level GRLM-70_-00 manufacturer is not responsible for failures related to the mounted measuring electrode.

ANCHORING OF THE ROPE ELECTRODE WITH WEIGHT AND ANCHORING RING

VALID FOR: GRLM-70_-33, 35

- At the bottom of the tank (silo), it is necessary to install an anchoring point (by welding or drilling an anchoring ring), to connect to the ring at the end of the electrode.
- This anchoring is recommended for applications with liquids, where turbulences occur or media is stirred, or for applications with bulk solids in small and medium sized silos (up to 10 m height).



Rope electrode level meter must untangle and then can be inserted into the tank.

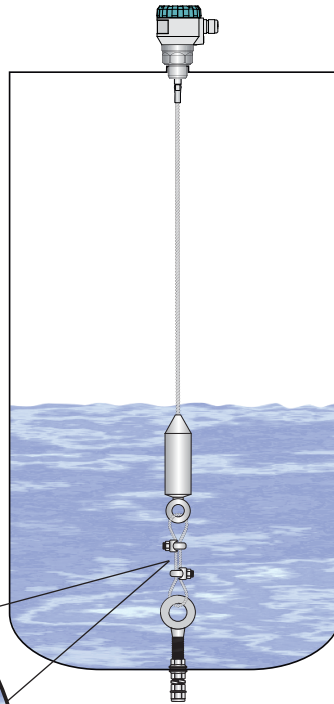
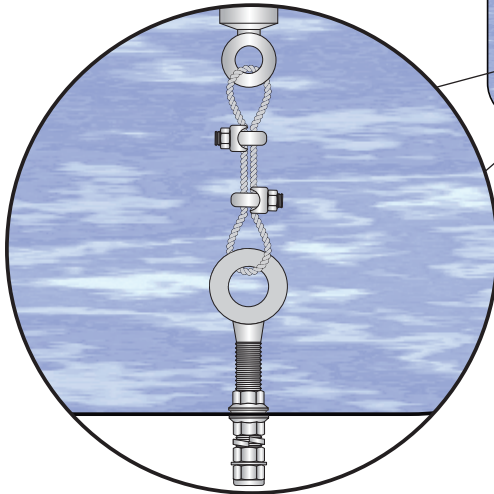

Fig. 18: Recommended Level meter installation with anchorage

ANCHORING OF THE ROPE ELECTRODE WITHOUT WEIGHT, ANCHORED WITH CLAMPS

VALID FOR: GRLM-70_-30, 34

- At the bottom of the tank (silo), it is necessary to install an anchoring point (by welding or drilling an anchoring ring), to pull the rope through and then attached with at least 2 clamps (3 clamps are recommended for deep silos over 20 m). The proposed length of the rope "E" must be longer than the depth of the tank (silo) by adding the length necessary to bend the rope and the part to be pulled through the anchoring ring.
- For applications with bulk solids** it is appropriate to anchor the rope electrodes at the opposite sides of the tank (silo) so that the rope is sagging, see Fig.20. Minimum recommended sag is $p = H/100$ [mm]. This installation increases the resistance of the rope to tension load.
- Minimum recommended distance of the sensor from the wall is $d = 1000 + H/50$ [mm]
- If the ratio of silo width to depth is determined by formula: $r \geq 1000 + H/20$ [mm], the rope can be anchored also on the same side of the silo, see Fig.19.

ANCHORING METHODS DEPENDING ON THE SIZE OF THE SILO

Anchoring method	r [mm]
opposite side of the silo (Fig. 20)	any
same side of silo (Fig. 19)	$\geq 1000 + H/20$

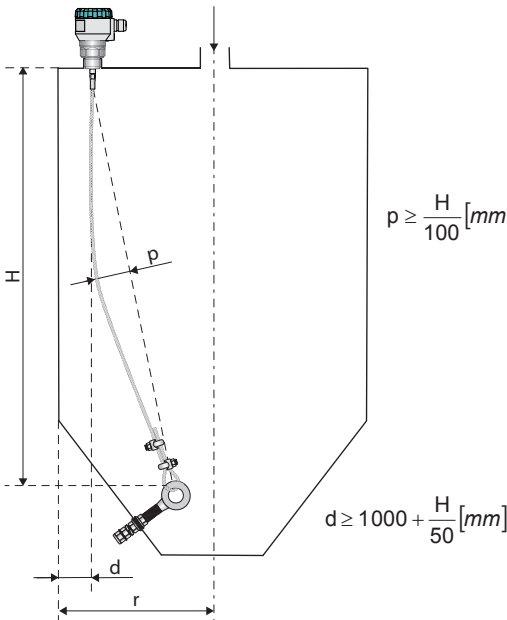

Fig. 19: Recommended installation of the level meter with anchoring on the same side of the silo

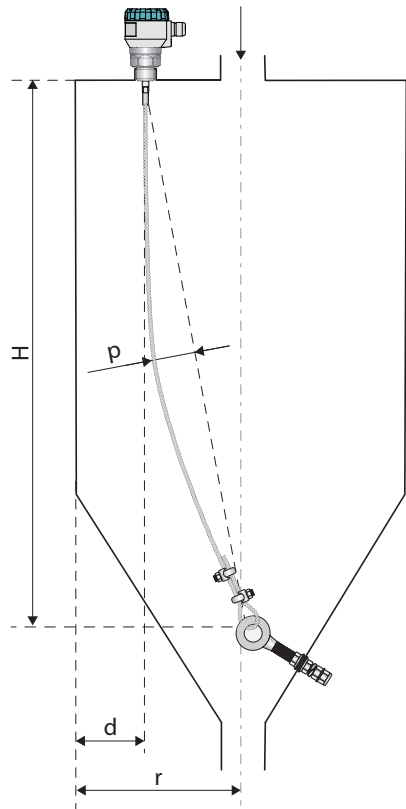

Fig. 20: Recommended installation of the level meter with anchoring on the opposite side of the silo

H – depth of the silo (from rope start to anchor)
 p – rope sag (see formula above)
 r – radius of the silo
 d – distance to wall (see formula above)

- Recommended for rod electrodes longer than 3 m.
- The end of the measuring electrode may be installed in a short tube welded to the bottom of the tank. At the bottom part of the anchoring tube, it is recommended to have a media overflow hole. The diameter of the tube should ensure permanent contact of the tube walls with the electrode. The diameter of the tube should ensure permanent contact of the tube walls with the electrode.

ELECTRODE WIDTH

electrode type	d
uncoated	8 mm
fully coated	10 mm

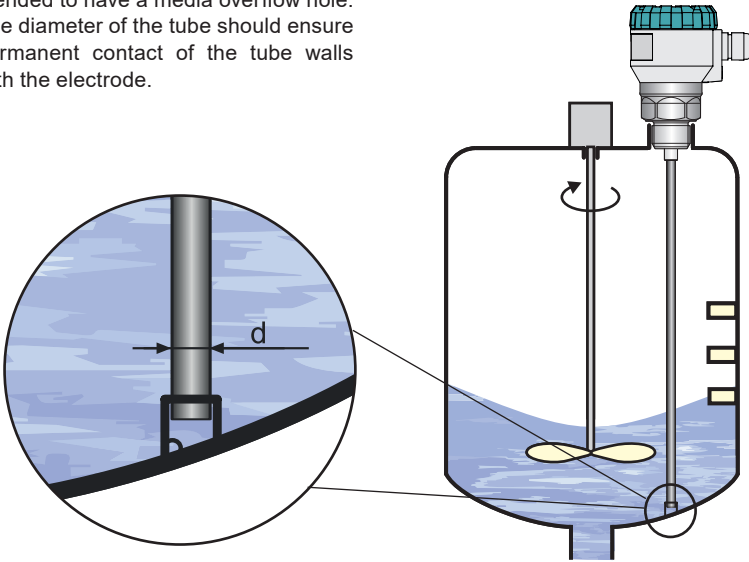

Fig. 21: Recommended installation of the level meter with anchoring of the rod electrode

7. ELECTRICAL CONNECTION

The level meter is connected to consequential (evaluating) device with a suitable cable with the outer diameter of 6 to 8 mm using screw terminals located under the display module. The recommended cross section of cores for the current version $2 \times 0,5 \div 0,75 \text{ mm}^2$ and for the version with Modbus communication $2 \times 2 \times 0,25 \text{ mm}^2$ (twisted pair, shielded). Plus pole (+U) is connected to the terminal (+), minus pole (0V) to the terminal (-) and the shielding (only for shielded cables) to the terminal (\perp). Communication wires A and B of the line RS-485 (for version "M" - Modbus) are connected to the terminals A and B.

Procedure to connect the cable to the level meter:

1. Unscrew the nut of the upper transparent lid.
2. Take the upper edge of the display module and take it out carefully by mild swinging up.
3. If you cannot grasp the module, you can use a small screwdriver. Insert it as far as the seam and use from several sides to slightly lift the module.
4. Release the cable outlet and thread the stripped supply cable in.
5. Connect the cable to the screw terminals according to the diagram in Fig. 23 or 25. Firmly tighten the terminals and the cable outlet. Tightening torque see. Technical parameters p. 36.
6. If the level meter with Modbus is involved as a terminal for RS-485, we recommend (to avoid reflections on the line) to connect 120Ω termination resistor. This is done by moving a small lever of the switch marked 120Ω to the ON position. On the level meters connected to the line RS-485 as an intermediate device, the termination resistors are not connected (switch remains off) in Fig 23.
7. Insert the display module back into the head so that the connector is properly connected.
8. Slide silicone seal on the thread of the level meter body, then tighten the nut of the upper lid. Connect the cable to consequential device.

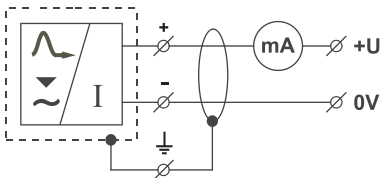

Fig. 22: Wiring diagram of the level meter with current output GRLM-70 _ _ _ - I

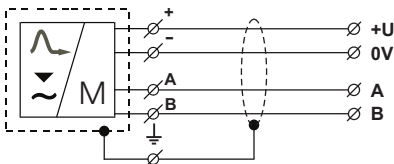

Fig. 24: Wiring diagram of the level meter with Modbus GRLM-70 _ _ _ - M

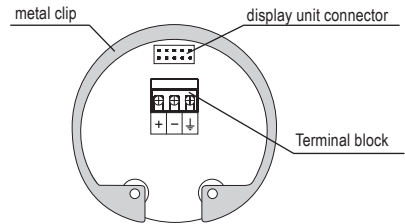

Fig. 23: Inside view of screw terminals of the level meter with current output GRLM-70 _ _ _ - I

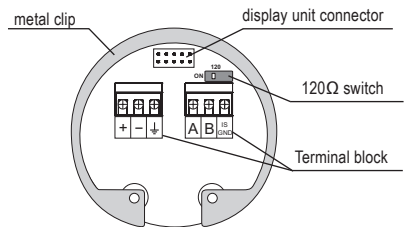

Fig. 25: Inside view of screw terminals of the level meter with Modbus GRLM-70 _ _ _ - M

Data connection RS-485:

Maximum distance of the module from the continuous line (length of T segment) is 3 m (fig. 26).

At the end units, it is necessary to connect terminating resistors R_z 120 Ω , whilst the terminating resistors must not be connected on the continuous units (fig. 26).

The cable must be a shielded twisted pair with a core cross-section of 0.35 .. 0.8 mm² with an impedance of approximately 120 Ω .

The cable shielding is connected to a shielding clamp on the connector of line RS485 and is connected with the clamp of the PE switchboard (direct grounding) only at a single point.

In the event that the RS-485 line is lead outside of one lighting arrester, it is necessary to protect it via suitable overvoltage protection.

In the event of communication problems caused by strong interference, it is appropriate to install the system inside a metal switchboard and to install the strong interference sources (e.g. frequency converters) away from this switchboard.

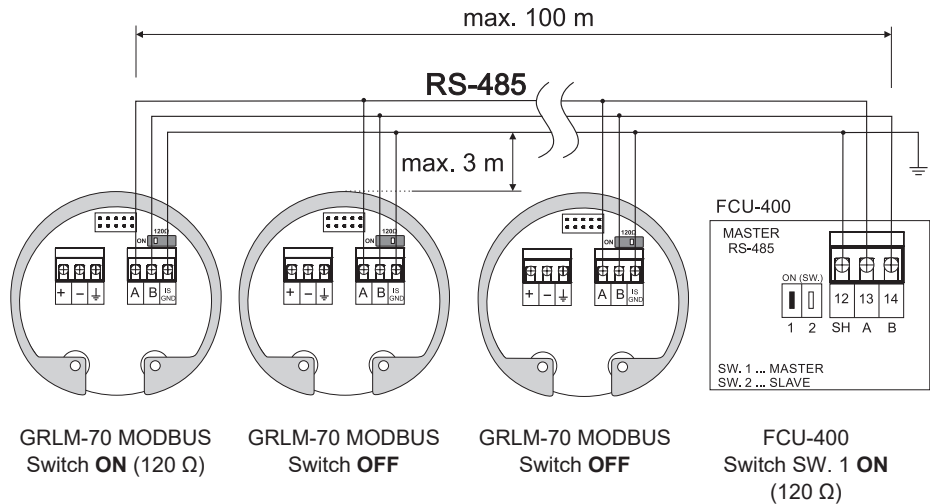

Fig. 26: Connection of multiple units via RS485 to a network



Electrical connection can only be made when de-energized!

The source of the power voltage must comprise of a stabilised safe low power source with galvanic separation. In the event that a switch-mode power supply is used, it is essential that its construction effectively suppresses common mode interference on the secondary side. In the event that the switch-mode power supply is equipped with a PE safety terminal, it must be unconditionally grounded! Spark-safe devices type GRLM-70Xi(XiT) must be powered from a spark-safe power source meeting the above-mentioned requirements.

Due to the possible occurrence of an electrostatic charge on the non-conductive parts of the sensor, it is necessary to ground all sensors intended for use in environments with an explosion hazard GRLM-70Xi(XiT) and GRLM-70Xd(XdT). This can be performed by grounding el. conductive tanks or el. conductive tank lids, and in the case of el. non-conductive tanks using and grounding an auxiliary plate electrode PDE-27. In the event that the sensor is installed in an outdoor environment at a distance greater than 20 m from the outdoor switchboard, or from an enclosed building, it is necessary to supplement the electrical cable leading to the sensor with suitable overvoltage protection.



In the event of strong ambient electromagnetic interference, paralleling of conductors with power distribution, or for distribution to distances over 30 m, we recommend grounding the level meter (see above) and using a shielded cable. Ground the shielding of the cable on the side of the power supply, or the shielding is possible to connect only on inside pin of the level meter marked  see fig. 23 and 25 (the shielding of the cable is always connected in a single location).

8. SETTING ELEMENTS

Settings are performed using 3 buttons located on the display module DM-70. All the settings are available in the menu of the level meter.

button 

- Set-up mode access
- Confirmation of selected item in the menu
- Move the cursor in the line
- Saving of set-up data

button 

- Move in the menu
- Change of values

button 

- Cancelling of carried out changes
- Shift one level up

• Status indication (left lower corner of the display):

symbol „E“ - alternating flashing - correct reception of the reflected wave indicating the level

symbol „T“ - permanent shine - "TEACHING" mode is activated

- **inverse shine** - activation of the "TEACHING" mode

symbol  - permanent shine - the level meter is locked against unauthorized setting using a password, enter password to unlock (see MENU - PASSWORD)

• Warning inscriptions:

NO ECHO - when empty tank, after you perform the procedure TEACHING
- level meter is not able to measure (check the media or change the sensitivity)

FIXED OUTPUT - the output stream is fixed to a constant value (see DIAGNOSTIC - CURRENT)

LOW POWER - low supply voltage (must be in the range - see Technical specifications)

NO PASSWORD - the level meter is protected using a password against unauthorized setting

NO DATA AVAILABLE - display module doesn't communicate with the electronics of the level meter (e.g. incorrectly inserted display module into connector or measuring module is not functional).

• Information inscriptions:

DISTANCE TO LEVEL - the display shows the current distance
(see DIAGNOSTIC - DISTANCE)

CURRENT - the display shows the current proud (see DIAGNOSTIC - CURRENT)



Level meter GRLM-70-_-_-_-L is supplied without the display module (display) DM-70. To setup the level meter, it is necessary to connect a display module to it (or it can be configured via HART or MODBUS). When the settings are completed, the display module may be disconnected and the level meter then measures without it.

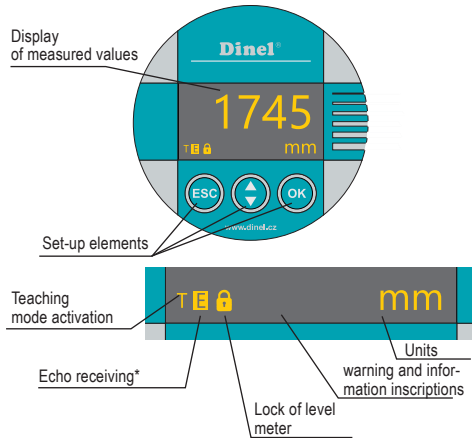

* Slow flashing while the reflected signal (echo) is received from the measured level.

9. SETTINGS

The level meter is manually controlled using 3 buttons located on the removable display module DM-70 (see chapter Control elements, pg. 19).

The text "SAVED" at the bottom of the display indicates that the values have been saved. Values not confirmed by pressing button **OK** will **not be saved!** After 5 minutes of inactivity, the level meter automatically switches back to the measuring mode. If the password is activated, the level meter will also lock itself. Once it is locked, it is not possible to make **any** changes to the settings. When any editing is attempted, the display will show the text "NO PASSWORD". The unlocking procedure is described on pg. 27.

After connecting the supply voltage, the display of the level meter will show the manufacturer's logo and the text "Starting" (approx. 30 s). Then the level meter switches to the measuring mode and the display shows the current measured value.

With the Modbus output variant, it is possible to setup the level meter using two-way communication via an industrial RS-485 bus with Modbus RTU protocol. The list of the respective registers is provided in a separate annex. The application "Basic SCADA level" can be used to setup the level meter and to collect measured data, and is freely available at the website www.dinel.cz.

9.1. BASIC SETTINGS

After the first start of the level meter it is necessary to perform the basic configuration (setting of the measuring range, choice of units, possibly damping, sensitivity and teaching). The settings are accessible in the basic menu by pressing **OK** the "BASIC SETTINGS".

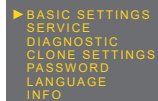

MIN LEVEL and MAX LEVEL

Here it is possible to freely define the **minimum / maximum distance of the level** (item "LEVEL" for currents 4 mA / 20 mA), to which a value can subsequently be assigned on the display in item "DISPLAY". Measuring units are set in the "UNITS" menu.

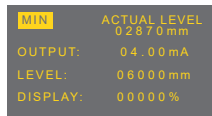

ACTUAL: actual distance to level

OUTPUT: current 4 mA / 20 mA

LEVEL: defining the min/max distance of the level meter from the surface level

DISPLAY: the value showed on the display

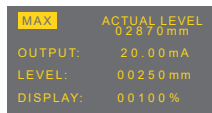
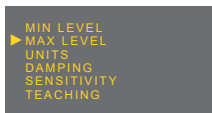

If in the bottom of the display appears (when entering the values) the inscription "OUT OF LIMITS", the value specified for the item "LEVEL" is outside the measuring range of the level meter. If the inscription "SPAN TOO SMALL" is shown, it must be specified a larger span between Min and Max values. For more information, see chapter "Specifications".

The decimal point position of the item 'LEVEL' is firmly set (according to the selected units), in the item "DISPLAY" it is freely adjustable.

1. To enter to the menu press **OK** the same button to select "BASIC SETTINGS". Then, using **↕** and **OK** select "MIN LEVEL" or "MAX LEVEL".
2. Now it is shown the item "MIN LEVEL" ("MAX LEVEL"). By pressing **OK** and **↕** set the output current "OUTPUT", the distance for the defined current "LEVEL" the value on the display "DISPLAY".
3. By pressing **OK** button save the data. By next presses of the button **ESC** leave the menu. The level meter returns to measurement mode.

UNITS

Level meter can process and convert a large number of different **physical values**. The setting is done in the item "UNITS".

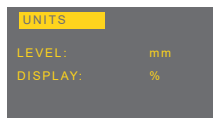

LEVEL: Unit selection
(mm, cm, m, in, ft)

DISPLAY: The unit showed on the display
(%, mm, cm, m, in, ft, l, hl, m³, gal, bbl, mA)

1. To enter to the menu press **OK** the same button to select "BASIC SETTINGS". Then, using **↕** and **OK** select "UNITS".
2. Now the menu item "UNITS" is shown. By pressing the **OK** and **↕** button make the settings of individual items.
3. By pressing **OK** button save the data. By next presses of the button **ESC** leave the menu. The level meter returns to measurement mode.

DAMPING

Setting the **response time** of the measurements. The function is useful for suppressing level fluctuations, waves and rapid changes of the level. The reaction time will depend on the exponential function. Damping with a defined delay in seconds represents the time when exponential reaches 2/3 of its maximum value.

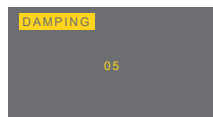

The damping time can be set in the interval from 0 to 99 s.

1. To enter to the menu press **OK** the same button to select "BASIC SETTINGS". Then, using **↕** and **OK** select "DAMPING".
2. Now the menu item "DAMPING" is shown. By pressing the **OK** and **↕** button make the settings of individual items.
3. By pressing **OK** button save the data. By next presses of the button **ESC** leave the menu. The level meter returns to measurement mode.

SENSITIVITY









Sensitivity level meter is defined in four steps. Three steps are basic sensitivity and fourth step contains user options.

- STEP 1 - „LOW“ – Low sensitivity in case of surrounding interferences affecting the measurement.
- STEP 3 - „MEDIUM“ – Medium sensitivity (suitable for most applications).
- STEP 5 - „HIGH“ – Enhanced sensitivity for measured mediums partly absorbing the guided wave (foams)
- STEP 1 - 8 - „USER“ – user freely adjustable sensitivity in eight steps



You can set the sensitivity in four degrees:

- LOW (1)
- MEDIUM (3)
- HIGH (5)
- USER (1 - 8)

1. Pressing the button  is for enter the menu, press the same button to select the item "BASIC SETTINGS". Then by pressing the buttons  and  is selected the item "SENSITIVITY".
2. Using the buttons  and  set the proper sensitivity.
3. After switching the sensitivity to step "USER", the user can move through different (eight) levels of sensitivity by pressing .
4. After completion of setting pressing of the  button saves the setting. Continue by pressing  to exit a menu and the level meter returns to the measuring mode.



Sensitivity steps 6-8 are highly sensitive, so use them only in exceptional cases for media with a low dielectric constant, or after consultation with the manufacturer.



Table of recommended sensitivity according to rel. permittivity of the medium is given on page 41.

TEACHING

The mode serves for **suppressing false reflections** resulting from reflection of the guided wave from roughnesses on walls of the tank, various partitions, mixers, other obstacles, or if distance electrode from the wall of tank is lower than 300 mm. The sensor starting this mode detects false reflections and save them in the memory. Then these false reflections will not affect the subsequent measurement (they are masked).

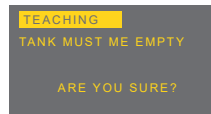

1. To enter to the menu press **OK** the same button to select "BASIC SETTINGS". Then, using **↕** and **OK** select "TEACHING".
2. Now the menu item "TEACHING" is shown. After pressing the button **OK** you are asked if you are sure to run the "TEACHING" procedure. By pressing **OK** button the system starts "teaching" (false reflection mapping). During the mapping, the display shows flashing sign "RUNNING".
3. The procedure is completely finished when you can see the inscription "DONE". It is then possible to exit the menu by repeated pressing the button **ESC**.

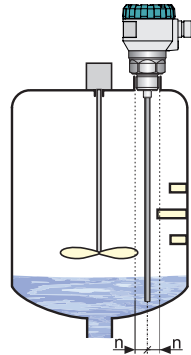

$n = 100 \text{ mm}$
 n - minimal distance of objects from the electrode from level meter

Before starting the mode, it is necessary to completely empty the tank!

In case of installed mixers, it is **necessary** to position the mixers near the level meter (turning the mixer blade to the proximity of the electrode).

Note: If there are significant obstacles in the upper half of the tank, **multiple false reflections** can occur especially in closed tanks.

Fig. 24: Turning the mixer blade to the proximity of the electrode before activation "Teaching" mode

9.2. SERVICE SETTINGS

In the supplemented configuration, you can set parameters of sensitivity, mapping of false reflections, temperature difference compensation, behaviour in case of fault conditions or HART® communication. Here, you can set the sensor into the initial state or reset it as well. The settings are accessible in the basic menu under the item "SERVICE".

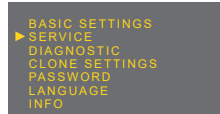

ELECTRODE

Setting the **electrode length and type** The function is used in the case where the length (e.g. electrode is shortened) or the type (replacement of a rod electrode with a rope electrode) of an electrode changes.

The length of the electrode can be changed on types: 10, 13, 30, 33, 34 and 35

The electrode type can be changed on types: 10, 30, 33, 34 and 35.

Types 11, 12, 20 and 32 cannot be changed. On type 13, only the electrode length can be changed.



Before setting of the length and type of the electrode it is first necessary to empty the tank in which the level meter is placed, since in this tank will be necessary to run the procedure "TEACHING"

First the electrode type is confirmed (check that the confirmed electrode type complies with the actually installed type of measuring electrode). Then the function "MANUALLY" is selected and the actual electrode **length** is entered on the display or the "AUTO DETECTION" function is selected and the level meter measures the electrode length itself

ELECTRODE
FAILURE MODE
HART
FACTORY DEFAULT
RESET

ELECTRODE
TANK MUST BE EMPTY
TYPE: 10
LENGTH: MANUAL
05000 mm

There are 5 options for the electrode type:

10 – 30 – 33 – 34 – 35

The electrode length can be entered in two ways:

MANUALLY – AUTO DETECTION.



The function of Autodetection can only be used for electrodes longer than 1000 mm.



The procedure for replacing or shortening the electrode is given in chapter 12. on page 31. In case of confusion, contact the manufacturer.



In the event that the electrode type and length settings are made away from the tank, it is necessary, before starting the setting process, to place a metal plate with a diameter greater than 200 mm (fig. 26) in the location of the process connection of the level meter. The metal plate must be in contact with the thread stop of the level meter.

FAILURE MODE

It defines the output current of the level meter in case of echo loss ("NO ECHO").

ELECTRODE
FAILURE MODE
HART
FACTORY DEFAULT
RESET

FAILURE MODE
NO ECHO: 4.00 mA

NO ECHO: Current in case of echo loss

The values can be set in five steps:

3,75 mA – 4 mA – 20 mA – 22 mA –
LAST (last measured data).

HART

This item is a part of the level meter with a ULM-70 _ _ _ I current output. Settings for HART® protocol (point to point, multidrop) and addresses for the multidrop mode. In multidrop mode, up to 15 devices can be connected to a single two wire cable.

ELECTRODE
FAILURE MODE
HART
FACTORY DEFAULT
RESET

HART
POLLING ADDRESS
00

In the case of address "00", the *point to point* mode is activated. The range "01" to "15" is reserved for addresses in the *multidrop* mode (current is fixed at 4 mA).

MODBUS

This item is part of a menu with Modbus output level meter GRLM-70 _ _ _ M. Modbus mode is intended for the settings of the level Modbus addresses, baud rate and parity settings

MEDIUM TEMPERATURE
FAILURE MODE
MODBUS
FACTORY DEFAULT
RESET

MODBUS
ADDRESS: 001
BAUD RATE: 9600
FORMAT: 8N1

ADDRESS: 1 to 247 (default 1)

BAUD RATE: 4800, 9600, 19200 (default 9600)

FORMAT : 8N1, 8O1, 8E1, 8N2 (default 8N1)

FORMAT: — number of stop bits: 1, 2
parita: N – non parity
O – odd parity
E – even parity
data: 8 – number of bits

FACTORY DEFAULT

Load the factory default settings to the level meter. They are loaded by pressing button .

The default settings table is provided on pg. 41.

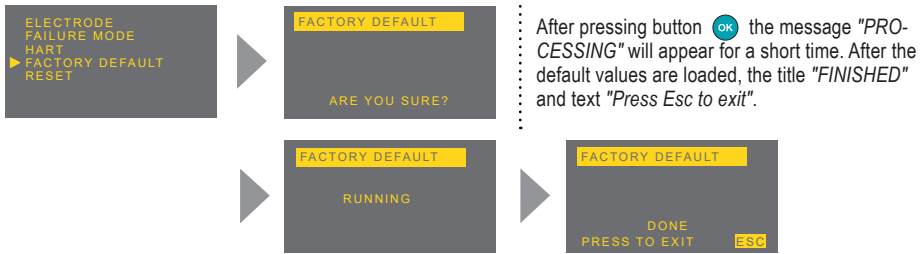

RESET

Complete restart of the level meter. The same effect has also a short-time interruption of the supply voltage. To enable the resetting, press the button .



9.3. ADDITIONAL FUNCTIONS

Additional functions include modes for copying settings or diagnostics. Furthermore, password-protected editing, language mutations, and level meter version information (of the display module). All these functions are accessible from the main menu.

DIAGNOSTIC

DISTANCE TO LEVEL : display the actual value of the distance from the sensor to the level of the measured medium.



CURRENT: display the actual value of the output current flowing through the loop



- ON DISPLAY: YES (the main display shows value from diagnostics: distance to level, current)
- NO (the main display shows the stand. measured value set by the DISPLAY parameter in the MIN / MAX LEVEL)

- SET VALUE: setting the current to a fixed value
(3,75 mA - 4 mA - 12 mA - 20 mA - 22 mA - MEASUR.)
- If parameter MEASUR. is selected, current corresponds with the measured value)



Option SET VALUE can be used to diagnose the connected evaluation device.

If the current is set (fixed) to a fixed value, the main display shows the FIX OUTPUT and in section SET VALUE a title appears FIXED.

CLONE SETTINGS

This mode is intended for **copying** of the level meter (GRLM-70 body) **configuration into the display module** (DM-70) and back. The display module can then be removed from the level meter body and put into another level meter and make there the settings transfer (cloning).

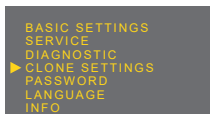

The "CLONE SETTINGS" mode transfers all data, excluding setting of the "Teaching" and HART®.

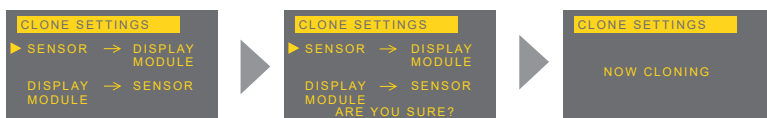

1. Press **OK** to enter the menu and select the item "CLONE SETTINGS". Copying of the settings from the body of the level meter to display module is done by selecting "SENSOR → DISPLAY MODULE". To transfer the settings from the display module to another level meter select the item DISPLAY MODULE → SENSOR.
2. The selected mode starts by pressing button **OK**. During transmission the display shows "NOW CLONING".
3. After completing the process in the middle of the screen displays "DONE". It is then possible to leave the menu and the mode by pressing the button **ESC**.



Incompatible type of level meter and length of electrode. Transfer of the settings can be realized only with the same type of level meter and with same length of electrode.









The data set **is not stored into the display module** (DM-70). The transfer can not be done. It is necessary to repeat the procedure of the copying the settings in the mode "CLONE SETTINGS".

PASSWORD

You can lock the level meter data against unauthorized editing. After activating the password the data may be read, but can not be edited. If you try to edit the settings (without true password) the display shows "NO PASSWORD".

The password can be any 5-digit numeric combination. The combination of numbers 00000 is reserved for disabling the password.

1. Use the buttons  and  in the menu "PASSWORD" to select the mode "ENTER" for entering the password or the mode "CHANGE" for changing the password (when activated, the words are displayed inversely). Press the button  once again to confirm the selection. You can change the password only when the level meter is unlocked. Otherwise, the words "NO PASSWORD" will be displayed.
2. Now you can edit the password. The actual edited item is displayed inversely. Press the button  to move to the next position (clockwise direction), button  serves to change the values (0 ... 9).
3. After the operation is completed, confirm the edited data by pressing the button .

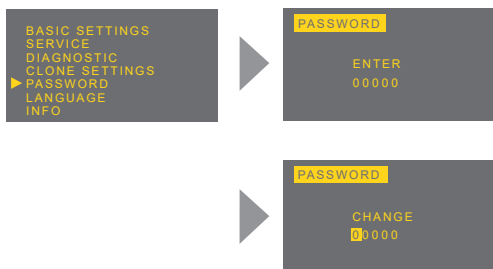

Display of status information to confirm data:

„YES“ – correctly edited password

„NO“ – incorrectly edited password

„OK“ – the password saved (only in case of "CHANGE")

The password is automatically hidden after it is edited or changed ("00000" will appear).

To deactivate the password, edit the numerical combination "00000" in the mode "CHANGE".



If the password is lost, contact the manufacturer.



The level meter with activated password will be automatically locked after 5 minutes of inactivity or after 5 min. from switching to measuring mode. Locking of level meter is indicated in the lower left corner of the screen by the symbol .

LANGUAGE

Setting the language of display menu.



You can set three kinds of language:

ČESKY – ENGLISH – по русски

INFO

Information about the type, serial number and production date of the level meter (type, serial number – SN and firmware version – SW).

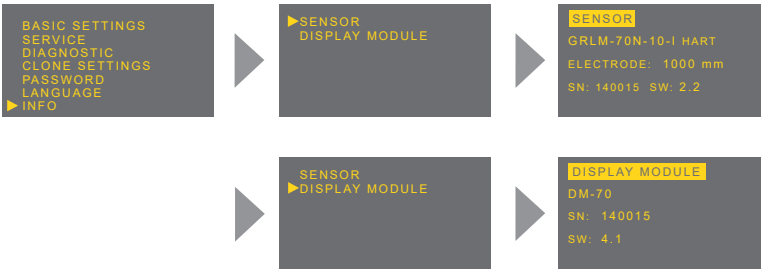

10. HART® COMMUNICATION PROTOCOL

Universal communication interface for data communication of peripheral devices with the level meter. Data transmission runs through the same line as the 4 ÷ 20mA current loop without impact on analog communication. For setting the level meter and collection of measured data, it is necessary to have available a HART communicator, by which it is possible to communicate directly with the level meter, or using it, to mediate communication with a peripheral device, see image 28.

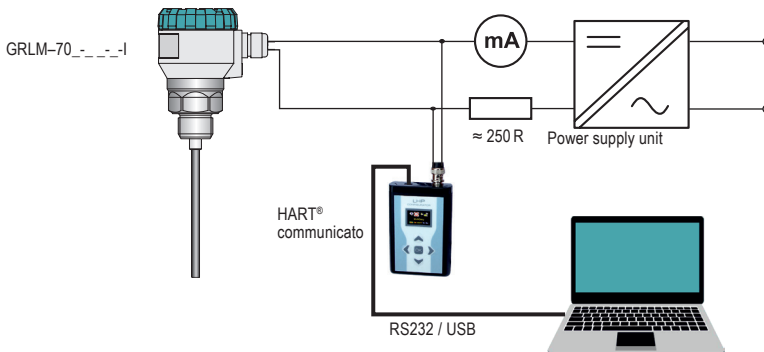

Fig. 25 Typical hardware configuration with HART

HART Specifications

The version of the HART Protocol is revision 5.

Universal Commands: 0, 1, 2, 3, 6, 11, 12, 13, 14, 15, 16, 17, 18, 19 a

Commons Practice Commands: 34, 35, 40, 42, 44, 49.

Meaning of variables

PV - distance to level

SV - the value displayed on the display

TV - not used

FV - level height

11. PROTOCOL MODBUS®

Universal communication interface for communication between peripheral devices and the level meter. Data communication takes place along a series line of a standard RS-485 with protocol Modbus RTU. A list of relevant variables is provided in a separate annex. To set up the level meter and collect measured data, you can use the software application "Basic SCADA level", which is freely available at the Website www.dinel.cz. Connecting the level meter to a peripheral device can be performed using a converter URC-485, see image 29.

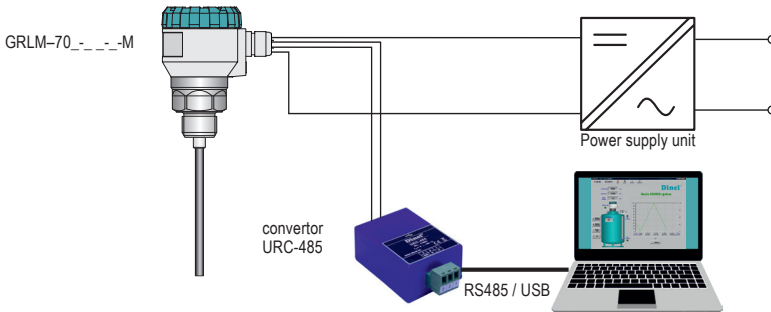

Fig. 26: Typical hardware configuration with Modbus®

12. THE INSTALLATION OF THE CUSTOM MEASURING ELECTRODE, EXCHANGE OR SHORTENING OF THE ELECTRODE

The installation of the custom measuring electrode, - applies to type 00

1. Create your own electrode as shown on Fig. 31. The length of the electrode must be about 7 mm shorter than the dimension "E" in figure 30. The material of the electrode is recommended to be used stainless steel type 1.4404 (AISI 316 L) or similar depending on the application.
2. Apply glue intended for securing threaded junctions (the amount of adhesive is determined by its manufacturer) on to the thread of the prepared electrode produced according to drawing (see pic. 31). The glue used must meet certain criteria depending on the application, e.g. resistance against high temperatures, corrosion, chemicals or must have a permit, e.g. for use in food processing.
3. Screw the electrode using suitable pliers or a spanner (on the side of the electrode) and a flat spanner 10 mm (on the side of the electrode holder) firmly into the electrode holder.
4. Let the glued junction to harden, as recommended by the glue manufacturer, then the level meter is ready for installation.
5. After an installation into an empty tank, set a new level meter electrode type and the length - see Chap. 9.2. ELECTRODE
6. If necessary, enter a new range of level measurement - see Chap. 9.1. MIN / MAX LEVEL.

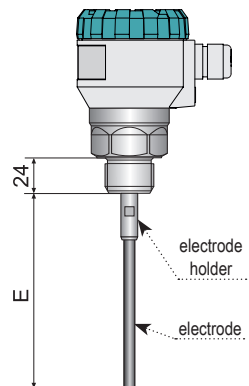

Fig. 27: Drawing of the level meter with size "E"

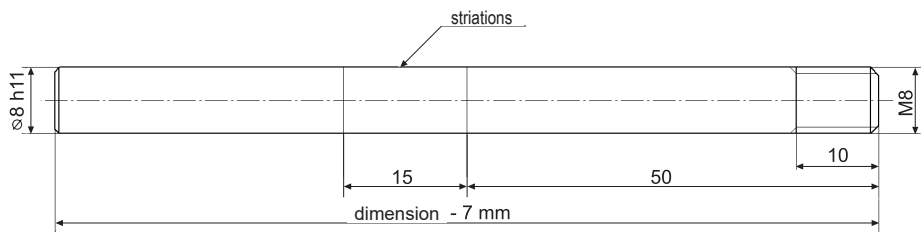

Fig. 28: The drawing of the measuring electrode marked with the threaded connection and grooving

The procedure of replacement of the measure electrode - only to versions 10, 30, 33, 34, 35

1. Heat the junction place (threaded connection) of the electrode and the electrode holder (see Fig. 31 and 33) using a heat gun at about 120-150 ° C (or 220-250 ° C for high temperature version).
2. Unscrew the electrode using suitable pliers (for rod electrodes) or flat spanner 7 mm (in case of rope electrode) and a flat spanner 10 mm (on the side of the electrode holder) away from the electrode holder.
3. Apply the glue for securing of threaded fasteners (glue quantity specified by the manufacturer) to the thread of the new electrode. The used glue must meet the requirements depend on the specific application, for example: withstanding high temperatures, corrosive chemicals, resp. contact with food.
4. Screw the electrode using suitable pliers or a spanner (on the side of the electrode) and a flat spanner 10 mm (on the side of the electrode holder) firmly into the electrode holder.
5. Let the glued junction to harden, as recommended by the glue manufacturer, then the level meter is ready for installation.
6. After an installation into an empty tank, set a new level meter electrode type and the length - see Chap. 9.2. ELECTRODE
7. If necessary, enter a new range of level measurement - see Chap. 9.1. MIN / MAX LEVEL.

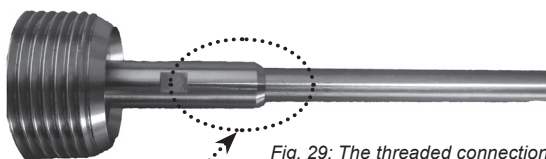

Fig. 29: The threaded connection of the electrode holder with the rod electrode

Places to be heated, see "The procedure of replacement of the measuring electrode....."

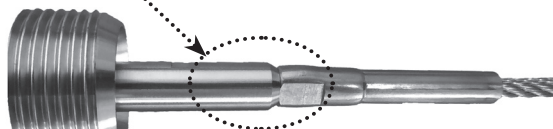

Fig. 30: The threaded connection of the electrode holder with the rope electrode

Shortening of the measuring electrode - only to versions 10, 13, 30, 33, 34, 35

1. If necessary, remove the rod or rope electrode from the electrode holder - see points 1 and 2 of "The procedure of replacement of the measuring electrode"
2. Shorten the rod electrode by means of a suitable metal saw and file the end of the electrode. The length of this electrode must be 7 mm shorter than dimension "E" in pic. 31. At the rope electrode, it is necessary to loosen three fastening screws on the ballast and to pull out the end of the cable, see fig. 34. Make sure that the cable length is correct after shortening – the cable is suspended in the ballast up to a distance of approximately 60 mm. Ideally, shorten the cable using diagonal cutting pliers. Be careful to prevent the end of the cable from fraying.
3. In the case of a cable coated with polyamide (types 34 and 35), this insulation must be removed at the end of the cable to a distance of 60 mm so that the end of the cable can be inserted back into the ballast.
4. Insert the end of the cable back into the ballast and secure it in place by tightening all three screws.
5. If you unmounted the electrode from the electrode holder, re-assemble them - see paragraphs 3 to 7 of "The procedure of replacement of the measuring electrode"

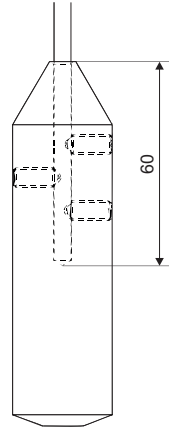

Fig. 31: Scheme of the weight for the rope electrode

13. FUNCTION AND STATUS INDICATION

Status and failure signalization, using:



- display module (see chapter 8)
- setting of the failure mode to the level selected in MENU - SERVICE - ERROR MODE (applies to current version with HART communication- **I**)
- status messages in HART communication (applies to current version with HART communication- **I**)
- status registers: STATUS 1 and STATUS 2 in MODBUS communication (applies to the version with MODBUS communication - **M**)

14. ORDER CODE

PRODUCT

GRLM-70

PERFORMANCE

N	non-explosive areas
NT	high temperature performance, non-explosive areas
Xd	for areas with a dust ignition hazard, can only be selected for electrical connection B
Xi	 for explosive environments, can only be selected with output type I
XiT	 high-temperature conf. for explosive environments, can only be selected with output type I
XdT	high temperature performance, can only be selected for electrical connection B

TYPE AND PERFORMANCE OF ELECTRODE

00	without electrode, CI50 process connection cannot be selected
10	uncoated stainless steel rod electrode, electrode length 0,5 ... 8 m, CI50 process connection cannot be selected
11	fully coated stainless steel rod electrode (PFA), electrode length 0,5 ... 2 m, cannot be selected for performance Xd, XdT and NPT process connection cannot be selected
12	fully coated stainless steel rod electrode (FEP), electrode length 0,5 ... 2 m, cannot be selected for performance Xd, XdT and NPT process connection cannot be selected
13	semi-coated stainless steel rod electrode (FEP), electrode length 0,5 ... 8 m, cannot be selected for performance Xd, XdT and NPT process connection cannot be selected
20	uncoated stainless steel rod electrode with reference tube (coaxial), electrode length 0,5 ... 3 m, cannot be selected for performance Xd, XdT and NPT and CI50 process connections cannot be selected
30	uncoated stainless steel rope electrode and weight, electrode length 1 ... 40 m, CI50 process connection cannot be selected
32	fully coated rope electrode and weight (FEP + PTFE), electrode length 1 ... 12 m, cannot be selected for performance Xd, XdT and NPT process connection cannot be selected
33	uncoated stainless steel rope electrode with anchorage, electrode length 1 ... 40 m, CI50 process connection cannot be selected
34	coated rope electrode (Polyamide) and uncoated weight, electrode length 1 ... 40 m, cannot be selected for performance Xi, XiT and CI50 process connection cannot be selected
35	coated rope electrode (Polyamide) and uncoated anchorage, electrode length 1 ... 40 m, cannot be selected for performance Xi, XiT and CI50 process connection cannot be selected

PROCESS CONNECTION

G1	thread G1"
CI50	Tri-Clamp Ø 50,5 mm, cannot be selected for performance type 10, 20, 30, 33, 34, 35
NPT	thread NPT 1", cannot be selected for performance type 11,12, 13, 20, 32, cannot be selected for performance NT, XiT, XdT

OUTPUT TYPE

I	current (with HART® communication)
M	RS-485 (Modbus RTU), cannot be selected for performance Xi, XiT

ELECTRICAL CONNECTION

B	short cable gland
H	cable gland for protective hose

SET-UP ELEMENTS

D	version with OLED display
C	version with LCD display
L	without display, full cap

LENGTH OF ELECTRODE

E	electrode length in mm
---	------------------------

GRLM-70 N - 10 - G - I - B - D E 20 MM

EXAMPLE OF CODING

15. CORRECT SPECIFICATION EXAMPLES

GRLM-70N-10-G-I-B-D E1000

(N) Performance for non-explosive areas; (10) Uncoated St. steel rod electrode; (G) Output type thread G1"; (I) Type of output current; (B) Connection method short cable outlet; (D) Set-up elements basic version with display; Length electrode 1 000 m.

GRLM-70Xi-12-G-I-H-L E1000

(Xi) Explosive environments performance; (12) Fully coated St. steel rod electrode (FEP); (G) Output type thread G1"; (I) Type of output current; (H) Connection method outlet for protective conductor; (L) Set-up elements without display, metal lid; Length electrode; Length electrode 1 000 m.

16. ACCESSORIES

standard – included in the level meter price

- 1x of seal (asbestos free), other seals (PTFE, Al, etc.) *

* Pressure resistance - see the table in the accessories datasheet in the "seals and gaskets".

optional – for a surcharge

(see catalogue sheet of accessories)

- Fixing stainless steel nuts G1"
- steel welding flange ON-G1"
- stainless steel welding flange NN-G1"
- extension cable for PK-70-1 display

17. SAFETY, PROTECTION, COMPATIBILITY AND EXPLOSION PROOF

The level meter is equipped with protection against electric shock on the electrode, reverse polarity, output current overload, short circuit and against current overload on output.

Protection against dangerous contact is provided by low safety voltage according to EN 33 2000-4-41 (SELV). Electromagnetic compatibility is provided by conformity with standards EN 5501 (B), EN 61326- 1, EN 61000-4-2 (A, 30kV), EN 61000-4-3 (A, 10kV), EN 61000-4-4 (A, 2kV), EN 61000-4-5 (A, 2kV), EN 61000-4-6 (A, 10kV).

Explosion proof GRLM-70Xi(XiT) is provided by conformity with standards EN 60079-0:2013; EN 60079-11:2012 and EN 60079-26:2007. Explosion proof GRLM-70Xi(XiT) is verified FTZÚ – AO 210 Ostrava – Radvanice: FTZÚ 13 ATEX 0212X.

Explosion proof GRLM-70Xd(XdT) is provided by conformity with standards EN 60079- 0:2013; EN 60079-31:2014. Explosion proof GRLM-70Xd(XdT) is verified FTZÚ – AO 210 Ostrava – Radvanice: FTZÚ 15 ATEX 0207X.

A declaration of conformity was issued for this device in the wording of Act No. 90/2016 Coll., as amended. Supplied electrical equipment matches the requirements of valid European directives for safety and electromagnetic compatibility.

Special conditions for safe use of variants GRLM-70Xi(XiT)

Level meters GRLM-70Xi (XiT) are designed for connection to intrinsically safe circuits with galvanic isolation. If you use the device without galvanic isolation (Zener barriers) it is necessary to offset a potential between the sensor and the grounding point of the barriers.

Maximum output parameters of intrinsically safe units must correspond with limit input parameters of the level meter. In the evaluation of intrinsic safety of the circuit must be taken into account the

parameters of the connected cable (especially its inductance and capacitance).

The electrode part of the GRLM-70Xi (XiT) can be placed in zone 0, the body with electronics can be placed in zone 1.

Special conditions for safe use of variants GRLM-70Xd(XdT)

Ambient temperature of housing Ta: -30°C to +70°C. Maximum surface temperature – see annex on page 40. When is used variant with sight glass cover, the housing shall be protected against direct sunlight. The electrode part of the GRLM-70Xd(XdT) can be placed in zone 20, the body with electronics can be placed in zone 21.

18. USE, MANIPULATION AND MAINTENANCE

The level meter does not require any personnel for its operation. Follow-up displaying device is used to inform the technological entity operating personnel on the measured substance level height during the operation and in the location of the level meter display.

Maintenance of this equipment consists in verification of integrity of the level meter and of the supply cable. Depending on the character of the substance measured, we recommend to verify at least once per year the measuring electrode of the radar level meter. In case any visible defects are discovered, the manufacturer or reseller of this equipment must be contacted immediately.



The level meter must be installed to prevent tensile overload of the rope electrode, see Technical parameters.



It is forbidden to perform any modifications or interventions into the GRLM-70 level meter without manufacturer's approval. Potential repairs must be carried out by the manufacturer or by a manufacturer authorized service organization only. Installation, commissioning, operation and maintenance of the GRLM-70 level meter has to be carried out in accordance with this instruction manual; the provisions of regulations in force regarding the installation of electrical equipment have to be adhered to.

19. GENERAL CONDITIONS AND WARRANTY

Dinel, s.r.o. guarantees for the period of three (3) years that the product has the characteristics as mentioned in the technical specification.

Dinel, s.r.o. is liable for defects ascertained within the warranty period and were claimed in writing.

This guarantee does not cover the damages resulting from misuse, improper installation or incorrect maintenance.

This guarantee ceases when the user or the other person makes any changes on the product or the product is mechanically or chemically damaged, or the serial number is not readable.

The warranty certificate must be presented to exercise a claim.

In the case of a rightful complaint, we will replace the product or its defective part. In both cases, the warranty period is extended by the period of repair.

20. MARKING OF LABELS

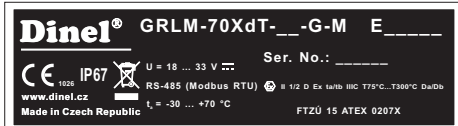
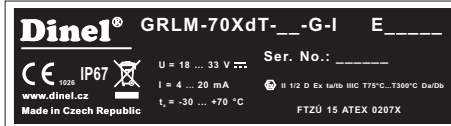
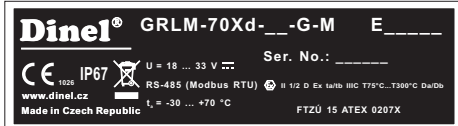
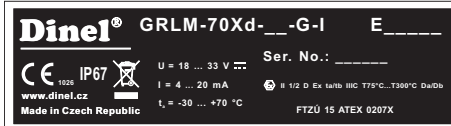
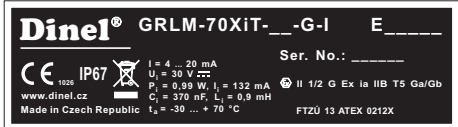
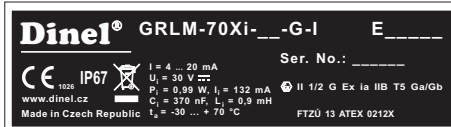
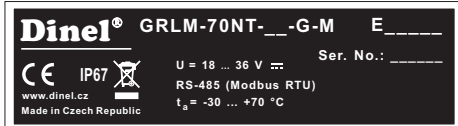
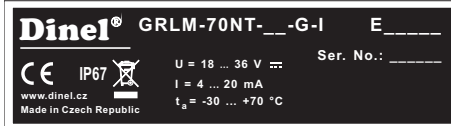
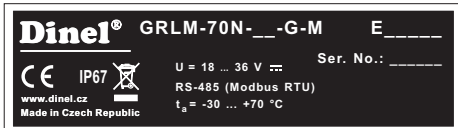
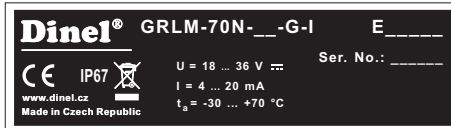

Labels for device of the type **GRLM-70N(NT; Xi; XiT; Xd; XdT)**

- Symbol of producer: logo Dinel®; Internet address: www.dinel.cz; Country of origin: Made in Czech Republic
- Level meter type:
 - GRLM-70N-__-G-I E_____, or GRLM-70N-__-G-M E_____
 - Supply voltage: U = 18...36 V =
 - Output current range: I = 4 ... 20 mA, or data communication RS-485 (Modbus RTU)
- GRLM-70Xi-__-G-I E_____
 - Output current range: I = 4 ... 20 mA
 - Limit operating parameters: U_i = 30 V =, I_i = 132 mA; P_i = 0,99 W; C_i = 370 nF; L_i = 0,9 mH
 - Label of non-explosive device: ; Performance: II 1/2 G Ex ia IIB T5 Ga/Gb
 - Number of certificate of intrinsically safety: FTZÚ 13 ATEX 0212X
- GRLM-70Xd-__-G-I E_____ GRLM-70Xd-__-G-M E_____
 - Supply voltage: U = 18...33 V =
 - Output current range: I = 4 ... 20 mA, or communication: RS-485 (Modbus RTU)
 - Label of non-explosive device: ; Performance: II 1/2 D Ex ta/tb IIC T75°C...T300°C Da/Db
 - Number of certificate of intrinsically safety: FTZÚ 15 ATEX 0207X
- Ambient temperature range: t_a = -30 ... +70 °C
- Serial number: Ser. No.: _____ (from the left: production year, serial production number)
- Protection class: IP67
- Compliance mark: CE, No. of authorized person examining control of system quality: 1026
- Electro-waste take-back system mark:

Size of labels 70 x 20 mm, the size shown does not correspond to reality.

21. TECHNICAL SPECIFICATIONS

TECHNICAL SPECIFICATIONS– LEVEL METER		
Supply voltage	GRLM–70N(T)–__ GRLM–70Xi(T)–__ GRLM–70Xd(T)–__	18 ... 36 V DC 18 ... 30 V DC 18 ... 33 V DC
Output	GRLM–70__-- -I GRLM–70__-- -M	4 ... 20 mA, HART® RS-485 with Modbus RTU
Current consumption	GRLM–70__-- -I GRLM–70__-- -M	4 ... 20 mA / max. 22 mA typ. 10 mA / max. 30 mA
Basic measurement accuracy (for reference reflecting surface ¹⁾)		± 2 mm (Fig. 32 - 35)
Error of current output ⁷⁾		max. 80 µA
Resolution		0,1 mm
Maximal length of measuring electrode	GRLM–70__-10, 13	8 m
	GRLM–70__-11 (12)	2 m
	GRLM–70__-20	3 m
	GRLM–70__-30 (33,34,35)	40 m
	GRLM–70__-32	12 m
Dead zone ²⁾	- measur. sensitivity: low, medium, user (1 - 4)	100 mm / 0 mm ³⁾
	- measur. sensitivity: high, user (5)	150 mm / 50 mm ³⁾
	- measur. sensitivity: user (6, 7)	200 mm / 50 mm ³⁾
	- measur. sensitivity: user (8)	250 mm / 50 mm ³⁾
Adjustable measuring range (SPAN)		min. 200 mm
Electrical parameters for variants Xi (XiT) – max. internal values		U _i =30 VDC; I _i =132 mA; P _i =0,99W; C _i =370 nF; L _i =0,9 mH
Measurement sensitivity (8 degrees)		low (1) - medium (3) - high (5) - user (1 - 8)
Failure indication (echo loss) adjustable in modes:		3,75 mA, 4 mA, 20 mA, 22 mA, LAST ⁴⁾
Damping		1 .. 99 s
Rise time		cca 60 s
Leakage resistance electrode - housing		10 kΩ
Coupling capacity (housing - power) / dielectric strength		5 nF / 500 V AC
Maximal resistance of current output load R _{max} for voltage - 24V DC / 22V DC / 20V DC		270 Ω / 180 Ω / 90 Ω ⁵⁾
Maximum tensile strength of the rope electrode		1400 kg
Tightening torque of cable gland	GRLM–70N(NT,Xi,XiT)	3 Nm (plastic)
	GRLM–70Xd(XdT)	7 Nm (steel)
Protection class		IP67
Recommended cable	GRLM–70__-- -I	PVC 2 x 0,75 mm ²
	GRLM–70__-- -M	PVC 2 x 2 x 0,25 mm ² (twisted pair, shielded)
Weight (without electrode)		cca 0,5 kg (1 kg variant T)

1) Metal round plate 0.5 m2, type with reference pipe GRLM-70_-20 water.

2) This error only applies to the version with current output. Data outputs (HART, MODBUS) are not loaded with this error.

3) Dead zone = blind zone = blocking distance at the beginning and end of the electrode.

4) In the event of an echo failure, the display shows the last measured value and the current is kept at the last valid value.

5) Including 250R resistor when connected to HART.

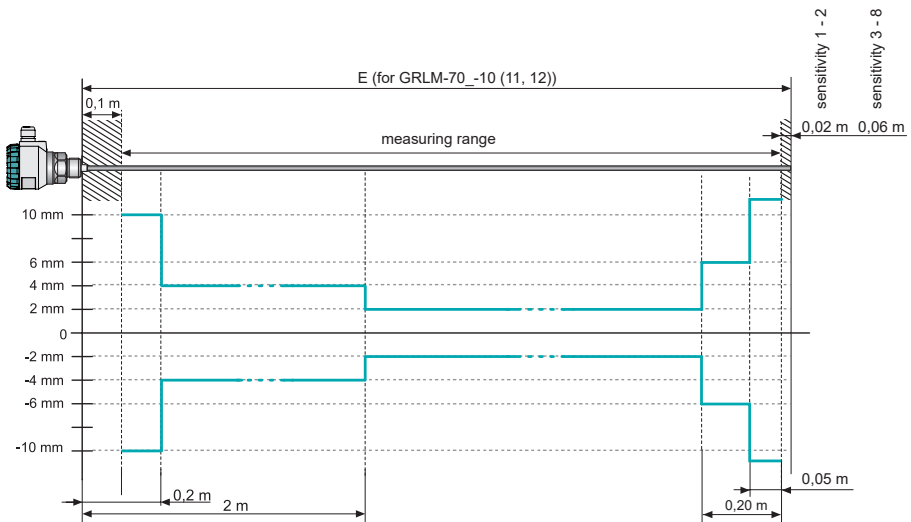

Fig. 32: Graph of the dead zones and measurement errors along the rod electrode with electrode (GRLM-70_-10(11, 12))

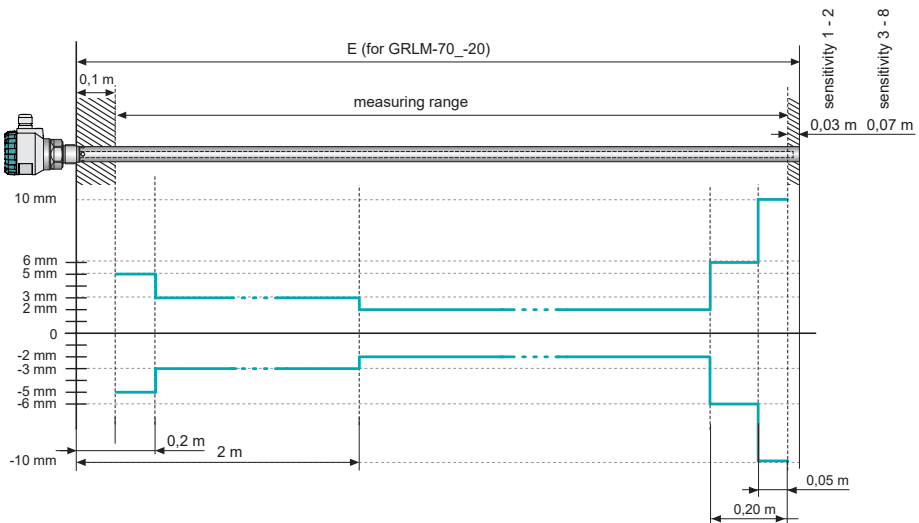

Fig. 33: Graph of the dead zones and measurement errors along the rod electrode with reference tube (coaxial) (GRLM-70_-20)

- hatched place shows dead zone
- measurement deviation depending on the distance of the level from the sensor

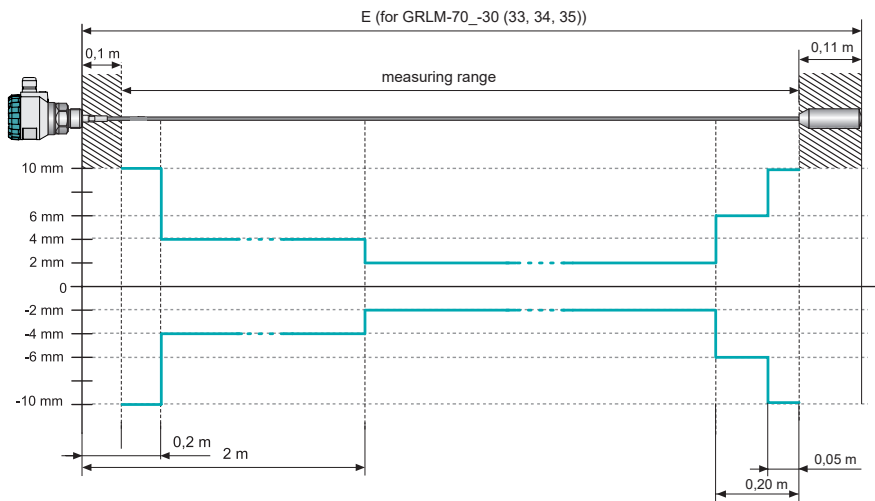

Fig. 34: Graph of the dead zones and measurement errors along the rod electrode with steel rope electrode and weight (GRLM-70_-30 (33, 34, 35))

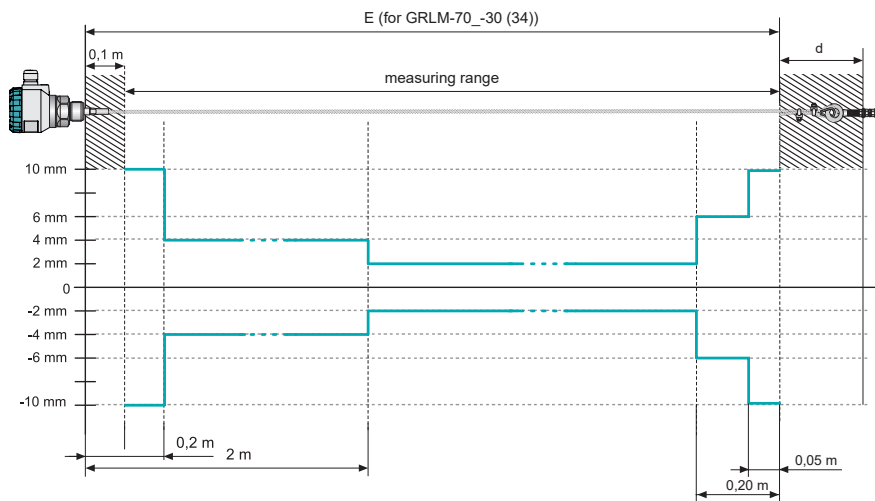

Fig. 35: Graph of the dead zones and measurement errors along the rod electrode with steel rope electrode (GRLM-70_-30(34))

- hatched place shows dead zone
- measurement deviation depending on the distance of the level from the sensor

TECHNICAL SPECIFICATIONS – DISPLAY MODULE

Type of display	matrix OLED, LCD ¹⁾	
Resolution	128 x 64 pixels	
Height of digits / Number of display digits of measured values	9 mm / 5 digits	
Colour of display	OLED	yellow
	LCD	black with white background light
Type of buttons	membrane	
Ambient temperature range	OLED	-30 ... +70 °C
	LCD	-20 ... +70 °C
Weight	46 g	

1) OLED- suitable for indoor and low-light applications. LCD – suitable for outdoor applications particularly with direct sunlight.

USED MATERIALS

Sensor part	Variants	Standard material
Lid	All types	aluminium alloy with powder coating
Glass	All types	polycarbonate
Body	All types	aluminium alloy with powder coating
Housing with thread	All types	St. Steel W. Nr. 1.4404 (AISI 316 L)
Electrode	GRLM-70_-10(11,12,13,20) GRLM-70_-30(32,33,34,35)	St. Steel W. Nr. 1.4404 (AISI 316 L) St. Steel W. Nr. 1.4401 (AISI 316)
Electrode coating	GRLM-70_-11 GRLM-70_-12, 13 GRLM-70_-32 GRLM-70_-34, 35	PFA FEP FEP PA
Reference tube	GRLM-70_-20	St. Steel W. Nr. 1.4301 (AISI 304)
Weight	GRLM-70_-30	St. Steel W. Nr. 1.4301 (AISI 304)
Weight coating	GRLM-70_-32	PTFE
Anchorage	GRLM-70_-33	St. Steel W. Nr. 1.4401 (AISI 316)
Display module	All types	plastic material POM
Cable gland	GRLM-70N(NT, Xi, XiT) GRLM-70Xd(XdT)	plastic - polyamide metal - nickel-plated brass

PROCESS CONNECTION

type	size	marking
Pipe thread	G 1"	G
Pressure thread	NPT 1"	NPT
Jointless connection (Tri-Clamp)	ø 50,5 mm	CI50

DEVICE CLASSIFICATION (according to EN 60079-10-1 and EN 60079-10-2)

Level meter performance	Type of electrode	Device classification
GRLM-70N	All types	Basic performance for non-explosive atmospheres.
GRLM-70NT	All types	High-temperature basic performance for non-explosive atmospheres (max. 200°C).
GRLM-70Xi(XiT)	00, 10, 11, 12, 13 20, 30, 32, 33	Intrinsically safe performance (high-temperature) for use in hazardous areas (explosive gas atmospheres), Ⓜ II 1/2 G Ex ia IIB T5 Ga/Gb with intrinsically safe supply units, electrode part zone 0, housing with electronics zone 1, see Fig. 37.
GRLM-70Xd(XdT)	00, 10, 30, 33, 34, 35	Performance (high-temperature) is protected by "Ex t" lock for hazardous areas (flammable dust areas), Ⓜ II 1/2 D Ex ta/tb IIIC T75°C...T300°C Da/Db, electrode part zone 20, housing with electronics zone 21 see Fig. 37.

TEMPERATURE AND PRESSURE RESISTANCE

Variant performance	temperature tm	temperature tp	temperature ta	Max. operation pressure for temp. tp	
				to 30°C	to 85°C
GRLM-70N(Xi,Xd)-10	-40°C ... +300°C	-40°C ... +85°C	-30°C ... +70°C	15 MPa	10 MPa
GRLM-70N(Xi,Xd)-20	-40°C ... +200°C	-40°C ... +85°C	-30°C ... +70°C	15 MPa	10 MPa
GRIM-70N(Xi)-11(12,13)	-40°C ... +200°C	-40°C ... +85°C	-30°C ... +70°C	4 MPa	2,5 MPa
GRLM-70N(Xi,Xd)-30(33)	-40°C ... +200°C	-40°C ... +85°C	-30°C ... +70°C	15 MPa	10 MPa
GRLM-70N(Xi)-32	-40°C ... +130°C	-40°C ... +85°C	-30°C ... +70°C	1 MPa	0,5 MPa
GRLM-70N(Xd)-34(35)	-40°C ... +95°C	-40°C ... +85°C	-30°C ... +70°C	15 MPa	10 MPa

TEMPERATURE RESISTANCE (high-temperature performance)

Variant performance	temperature tm	temperature tp	temperature ta
GRLM-70NT(XiT,XdT)-10	-40°C ... +300°C	-40°C ... +200°C	-30°C ... +70°C
GRLM-70NT(XiT,XdT)-20	-40°C ... +200°C	-40°C ... +200°C	-30°C ... +70°C
GRIM-70NT(XiT)-11(12,13)	-40°C ... +200°C	-40°C ... +200°C	-30°C ... +70°C
GRLM-70NT(XiT,XdT)-30(33)	-40°C ... +200°C	-40°C ... +130°C	-30°C ... +70°C
GRLM-70NT(XiT)-32	-40°C ... +130°C	-40°C ... +130°C	-30°C ... +70°C
GRLM-70NT(XdT)-34(35)	-40°C ... +95°C	-40°C ... +130°C	-30°C ... +70°C

Note.: For correct function of the level meter must not be exceeded any of the temperature range (tp, tm or ta).

MAXIMAL TEMPERATURES FOR PERFORMANCE Xi(XIT) CATEGORY 1/2G

temp. class (El. device of the group II)	temperature tm	temperature tp	temperature ta
T5 (100 °C)	-40°C ... +98°C	-40°C ... +90°C	-30°C ... +70°C
T4 (135 °C)	-40°C ... +133°C	-40°C ... +125°C	-30°C ... +70°C
T3 (200°C)	-40°C ... +198°C	-40°C ... +190°C	-30°C ... +70°C
T2 (300°C)	-40°C ... +298°C	-40°C ... +200°C	-30°C ... +70°C
T1 (450°C)	-40°C ... +300°C	-40°C ... +200°C	-30°C ... +70°C

MAXIMUM SURFACE TEMPERATURE OF THE DEVICE CONFIGURATION Xd(XdT) CATEGORY 1/2D

variant	device surface temperature	
All variants	in the place of the housing with electronics: in process connection: on the electrode:	ambient temperature $t_a + 5^\circ\text{C}$ max. equal to temperature t_p max. equal to temperature t_m

PRESSURE RESISTANCE (high-temperature performance)

Variant performance	Max. operation pressure for temp. t_p				
	to 30°C	to 85°C	to 130°C	to 160°C	to 200°C
GRLM-70NT(XiT,XdT)-10(20,30,33)	15 MPa	10 MPa	3 MPa ¹⁾	2 MPa ¹⁾	1 MPa ¹⁾
GRIM-70NT(XiT)-11(12,13)	4 MPa	2,5 MPa	2 MPa	1,5 MPa	0,3 MPa
GRLM-70NT(XiT,XdT)-34(35)	15 MPa	10 MPa	3 MPa ¹⁾	-	-
GRLM-70NT(XiT)-32	1 MPa	0,5 MPa	0,1 MPa	-	-

1). The mentioned values are not valid for hot water, water solution and steam, in such cases it is necessary to be consulted with the manufacturer.

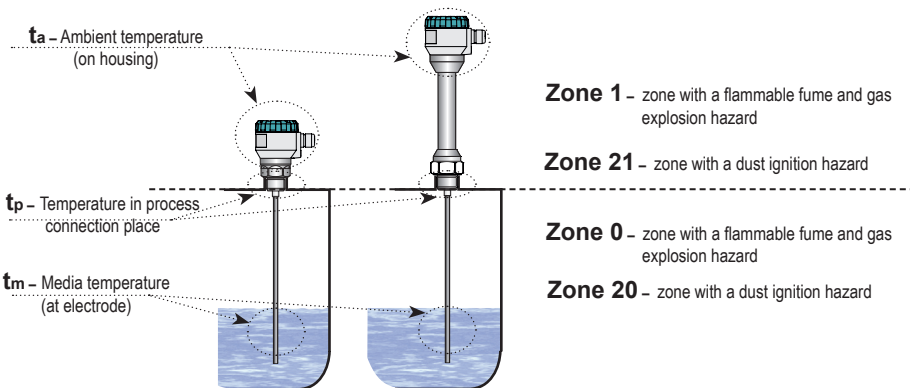

Fig. 36: Places for measurement of temperature and explosive areas

The maximum allowable temperature of the medium, process connection and ambient temperature depends in GRLM-70Xi (XiT) at the desired temperature class (see tab. Maximum temperatures for the performance Xi (XiT) category 1/2G and tab.). Maximal surface temperature at GRLM-70Xd(XdT) depends on ambient temperature, medium operating temperature and own warming device (see tab. Device surface temperature for performance Xd(XdT) category 1/2 D). The temperature value can not be exceeded, because the hot surface of the device could cause ignition of an explosive or flammable atmosphere. At the same time can not exceed the maximum temperature for the different variants of the electrodes (Table of temperature durability).

FACTORY DEFAULT

GRLM-70_ _ _	
MIN LEVEL (Distance to min. level)	according to the length of the rod (rope) electrode
MAX LEVEL (Distance to max. level)	100 mm
UNITS	mm; %; °C
DAMPING	2
SENSITIVITY	MEDIUM
MEDIUM	LIQUID
FAILURE MODE – NO ECHO	4,00 mA
POOLING ADDRESS (HART®)	00
PASSWORD	No password
Version with communication HART	
ADDRESS DEVICE	0
Version with communication MODBUS	
ADDRESS DEVICE	1
BAUD RATE	9 600
PARITY	NONE + 1 STOP Bit

RECOMMENDED SENSITIVITY DEPENDING ON THE DIELECTRIC CONSTANT OF THE MEDIUM

Degrees	Sensitivity	Rel. permittivity of the medium	
		for length of electrode to 20 m	for length of electrode over 20 m
8!	USER (extreme)	≥ 1,6	≥ 2
7!	USER (extreme)	≥ 1,8	≥ 4
6!	USER (extreme)	≥ 2	≥ 6
5	HIGH	≥ 3	≥ 8
4	USER	≥ 4	≥ 10
3	MEDIUM	≥ 6	≥ 13
2	USER	≥ 8	≥ 16
1	LOW	≥ 10	≥ 20



In the event that the measured medium is el. conductive (water, water solutions), then it is recommended to set sensitivity to level 1 - LOW.

22. PACKING, SHIPPING AND STORAGE

The device GRLM-70 is packaged in a polyethylene bag, and the entire consignment is placed into a cardboard box. A suitable filler material is used in the cardboard box to prevent mechanical damage during transport. Remove the device from the packaging only just before using, thereby protecting it from potential damage.

A forwarding company will be used to ship goods to the customer. Upon prior agreement, ordered goods can be picked up in person at company headquarters. When receiving, please check to see that the consignment is complete and matches the order, or to see if any damage has occurred to the packaging and device during transport. Do not use a device clearly damaged during transport, but rather contact the manufacturer in order to resolve the situation.

If the device is to be further shipped, it must be wrapped in its original packaging and protected against impact and weather conditions.

Store the device in its original packaging in dry areas covered from weather conditions, with humidity of up to 85 % without effects of chemically active substances. The storage temperature range is -10 °C to +50 °C.

Dinel[®]

industrial electronics

Dinel, s. r. o.
U Tescomy 249
760 01 Zlín
Czech Republic

phone: +420 577 002 002
e-mail: sale@dinel.cz

www.dinel.cz

valid for firmware version:
level meter 2.7 and higher
display module 4.9 a higher

Find the updated version at www.dinel.cz

version: 04/2019

