



## **FLOW CONTROL UNIT FCU-400**

---

applicable to firmware version 2.0



## TABLE OF CONTENTS

---

1. Measurement principle and application area .....	4
2. Dimension drawings .....	4
3. Put in service procedure.....	5
4. Level meter installation .....	6
5. Face panel and terminal block .....	6
6. Example of FCU-400 unit connection with ULM-53L-M level meters.....	6
7. Electric connection.....	7
8. Level meter setup .....	8
8.1. Device keyboard .....	8
8.2. Switching measurement ranges and menu navigation .....	8
8.3. Lock / unlock .....	10
8.4. Evaluation unit configuration.....	11
8.5. Reading statistical data .....	20
8.6. Other information.....	22
9. Marking method .....	23
10. Examples of correct marking .....	23
11. Protection, safety, and compatibility .....	23
12. Usage, operation, and maintenance .....	23
13. Marking of labels .....	23
14. Specifications .....	24

---

## USED SYMBOLS

In order to provide maximum safety of processes, we have defined the following safety and information instructions. Each of the instructions is marked with an icon.



### **Alert, warning, danger**

This symbol informs about particularly important instructions for installation and operation of equipment or about dangerous situations, which might occur during installation and operation. Failure to comply with the instructions may cause failures, damage, or destruction of the equipment, or may cause injuries of persons.



### **Information**

This symbol informs about particularly important characteristics of equipment.



### **Note**

This symbol identifies useful additional information.

## SAFETY



Any operations described in this user's guide may only be performed by trained worker, or by assigned person. Warranty and post-warranty repairs shall be performed exclusively at the manufacturer.

Incorrect usage, installation, or setup of the flow meter may result in accidents in application.

Manufacturer is not responsible for any incorrect usage, work losses resulting from direct or indirect damage, and expenses rising from the installation or usage of the flow meter.

Do not disassemble, repair, or modify the unit. The unit has no serviceable parts. In case you detect a failure, disconnect the unit from power supply voltage, and contact authorized service centre.

Do not use the unit in explosive environment.

Avoid unauthorized persons to contact with power supply terminals.

## 1. MEASUREMENT PRINCIPLE AND APPLICATION AREA

**Flow control unit FCU-400** is used to measure and display volume flow rate in open channels and drains. The unit forms an assembly with ULM-53L ultrasonic level meter with RS485/Modbus RTU communication output where the power supply for sensors is provided directly from the unit with output voltage of 24V DC. The unit can measure immediate flow rates in up to 4 channels simultaneously. The unit is integrated in an instrument box intended for wall mounting. Connection terminal block is positioned inside of the bottom part of the unit. On the front panel, there are four buttons used to set all functions. The units can be equipped with either two or four relay outputs. They also include RS485/Modbus RTU - Master communication interface for connection of sensors and RS 485/Modbus RTU - Slave interface for the communication with the master. On the front panel, there is a USB input for transmission of archived data from the unit to a flash disc in csv format. Customer can also select a web server, or 0/4 - 20 mA current output. Binary input is included in the basic configuration. Particular types can be ordered in two power supply versions.

## 2. DIMENSION DRAWINGS

FCU-400

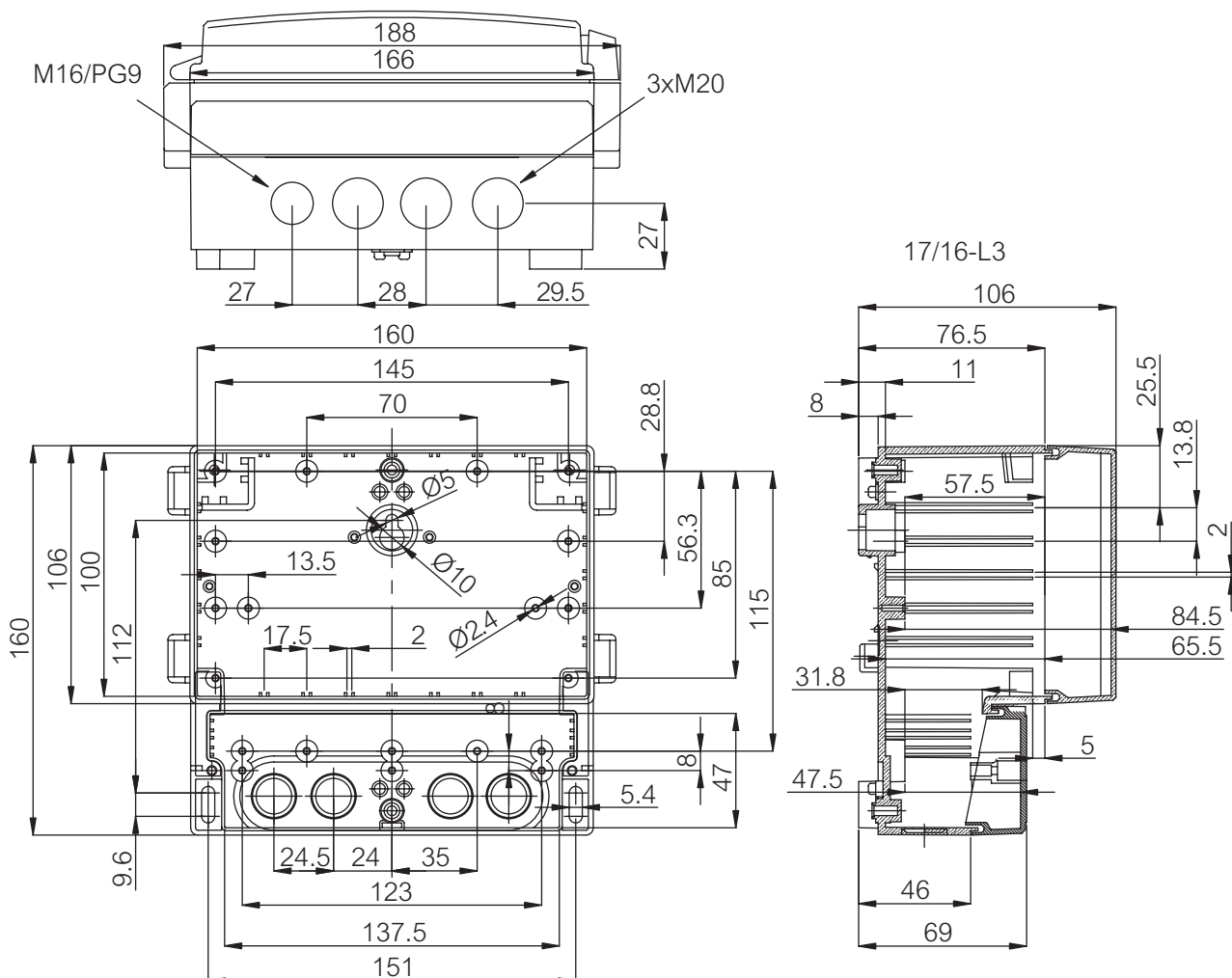

### 3. INSTALLATION AND PUTTING INTO OPERATION

This procedure includes the following three steps.

- **INSTALLATION**
- **ELECTRIC CONNECTION**
- **SETTING**

### 4. INSTALLATION



**Any assembly and installation work shall be done with disconnected power supply.**

- Both the measuring level meter and the control unit are designed for outdoors installation, and do not require any special construction and structure modifications of measuring profiles.
- The probed is designed for installation above flow profile.
- The values of flow rate and flown volume accuracy provided in specifications include an error due to the level measurement and conversion to the flow rate based on a consumption curve, however, they do not include error of specific flow rate profile.
- The measurement quality may be influenced by very high layer of foam on the water level.
- In case of measuring flumes, such a size must be selected to use its range well - it is inadmissible when the real flow rate value is only within the lower half of measuring range of the flume.
- In case of Thomson's overfall, units with small vertex angle should preferably be used so that the measured level is as high as possible.
- On case of flow at the upper limit of the working interval of the given measuring point, the level must be at least 30 cm, otherwise, the measurement accuracy is significantly lower.
- The control unit requires power supply of 230 V AC / 10 VA, or 24 V DC / 8 VA, the ultrasound probe is powered from the control unit.



**After the lower cover is unscrewed, L1, N, PE power supply terminal block is accessible. At this place, the equipment can only be operated by skilled person**

**with higher qualification (see decree no. 50/1978 Coll. on expert qualification in electrical engineering).**

**The measuring set accuracy depends on correct alignment of the probe, and setup of the unit operating parameters.**

- The unit is hash-proof and complies with safety standards. The installation should be done in compliance with local regulations.
- Before installation, learn about basic safety requirements provided on page 4.
- Make sure the power supply voltage in the grid complies with the nominal voltage indicated on the identification label of the unit.
- Load shall comply with requirements provided in specifications.
  
- Final assembly, commissioning, and programming of internal (non-user) parameters are done by a service group, or properly trained persons, if applicable!
- Before installation, disconnect the power supply source.
- Before the first startup, check the cables for correct connection to the unit.
- The measuring set accuracy depends on correct alignment of the probe, and setup of the unit operating parameters.

## 5. FACE PANEL AND TERMINAL BLOCK

terminal no.	all types of FCU-400
1	L / + (230 / 24 V)
2	N / - (230 / 24 V)
3	PE
4	RE 1 (100 mA / 250 V AC)
5	RE 1 (100 mA / 250 V AC)
6	RE 2 (100 mA / 250 V AC)
7	RE 2 (100 mA / 250 V AC)
8	RE 3 (24 V DC)
9	RE 3 (24 V DC)
10	RE 4 (24 V DC)
11	RE 4 (24 V DC)
12	Cable shielding (RS 485 - Master)
13	A (RS 485 - Master)
14	B (RS 485 - Master)
15	Cable shielding (RS 485 - Slave)
16	A (RS 485 - Slave)
17	B (RS 485 - Slave)
18	+U <sub>s</sub>
19	- U <sub>s</sub>
20	Bi (binary input for zero reset)
21	Bi (binary input for zero reset)

terminal no.	types FCU-400-R_-0(W)	type FCU-400-R_-I
22	RJ45/Ethernet	active current output (+ 24 V)
23	-	active current output (0 V)
24	-	passive current output (+)
25	-	passive current output (-)

FRONT PANEL

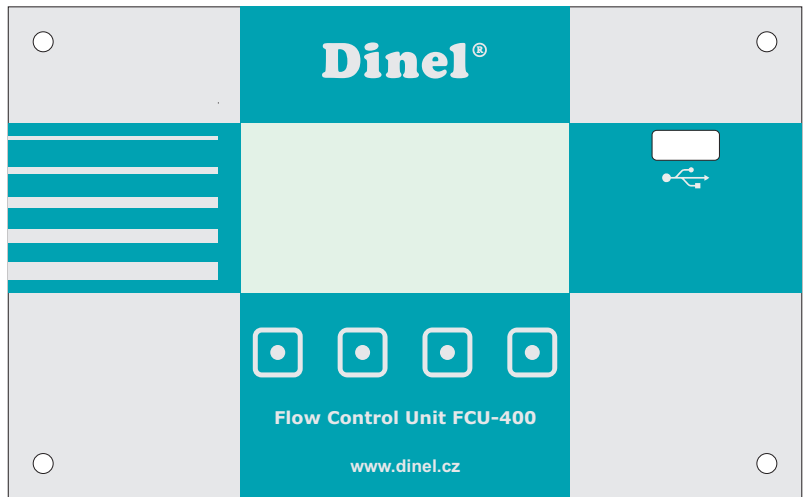

TERMINAL BLOCK FCU-400-R\_-0(W)

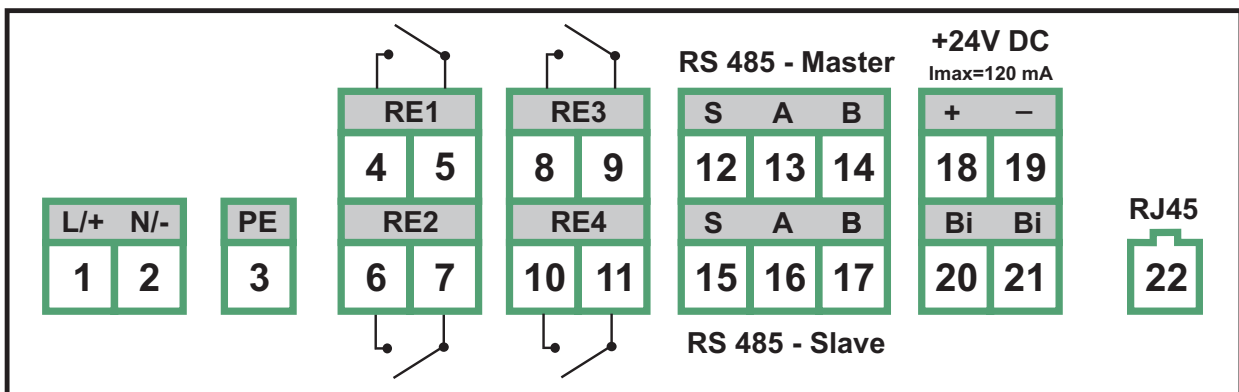

TERMINAL BLOCK FCU-400-R\_-I

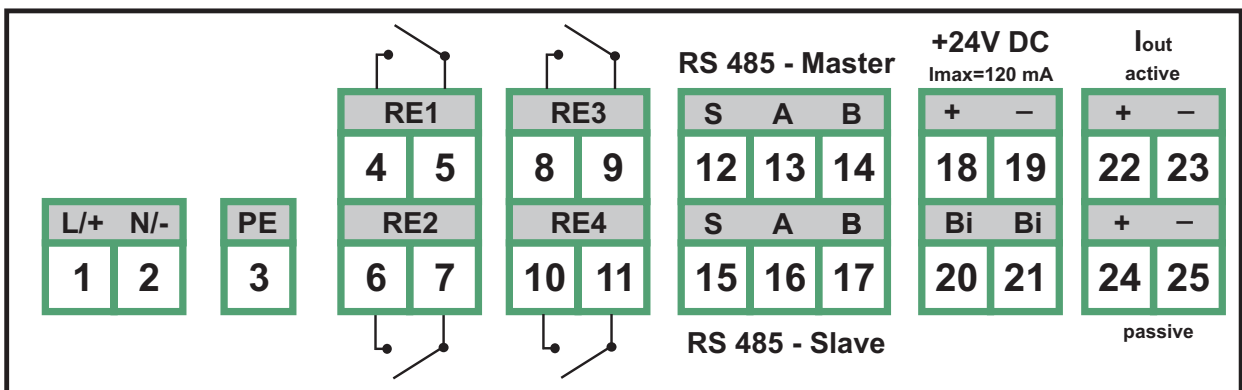

## 6. EXAMPLE OF FCU-400 UNIT CONNECTION WITH ULM-53L-M LEVEL METERS

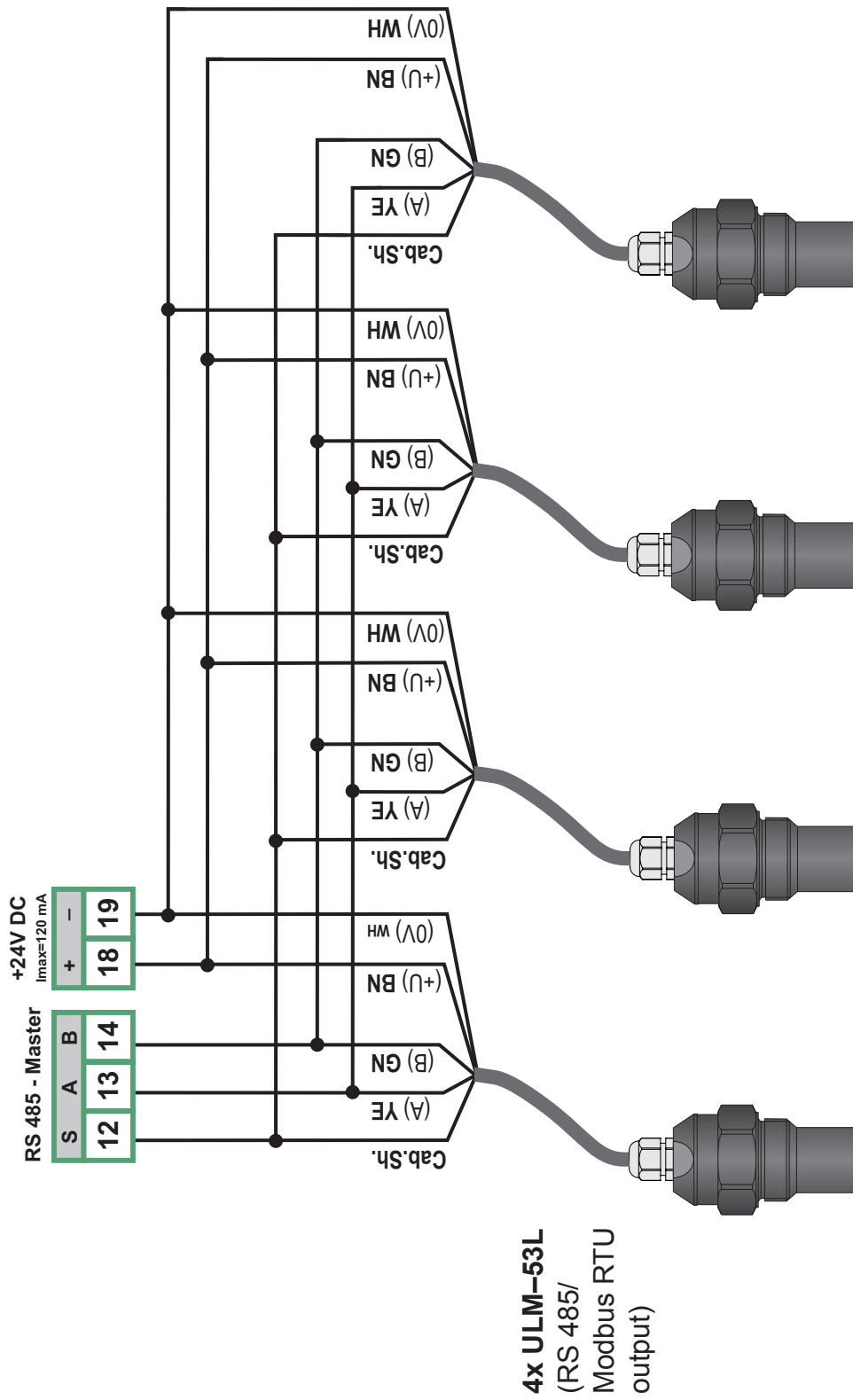

**legend:**

BN – brown    WH – white  
 YE – yellow    GN – green  
 Cab.Sh. – cable shielding

## 7. ELECTRIC CONNECTION



Electric connections shall be made without voltage.

- A terminal block is accessible after unscrewing the lower cover on the front part of the unit.
- The power supply voltage (terminals 1 and 2) can be connected to the grid **only using a fuse or breaker** (max. 16A)!
- Terminals 12, 13, and 14 (RS 485 - Master) are only used for the connection of approved level meters with Modbus (ULM-53L-M) output, see chapter 6.
- These level meters are powered from terminals 18 and 19, see chapter 6.
- The output of the equipment are working contacts (4, 5, and 6, 7, and 8,9, and 10,11).
- Terminals 15, 16, and 17 (RS 485 - Slave) are used as an interface for the Modbus communication with higher layer.

## 8. SETTING OF THE EVALUATION UNIT

Flow control unit FCU-400 can be operated using 4 buttons and OLED matrix display with resolution of 128x64 pixels. The buttons have various functions depending on their current position in menu. Actual functions of buttons are displayed in the lower part of the display above particular buttons.



After the unit setup completion, it is recommended to RESET (CONFIGURATION / RESET), and verify correctness of preset parameters!

### 8.1. DEVICE KEYBOARD

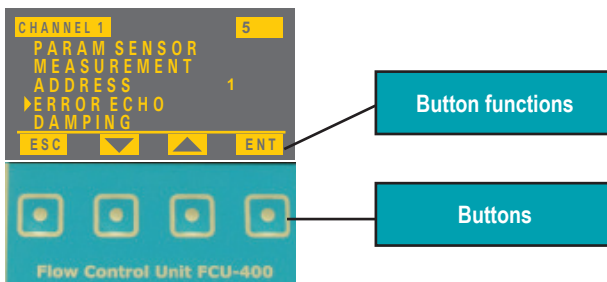

### 8.2. SWITCHING OF MEASURING CHANNELS AND MENU NAVIGATION

Actual measured flow rate is displayed on the main screen. The main screen type can be set in DISPLAY MODE menu. (see chapter 7.4.7. a)).

On the FLOW+TOTALIZER main screen, actual flow rate is shown with physical unit, its graphical representation, state of totalizer, state of output relays, and state of communication with sensor. The main screen is displayed just after the power supply is connected, and its graphical appearance is as follows:

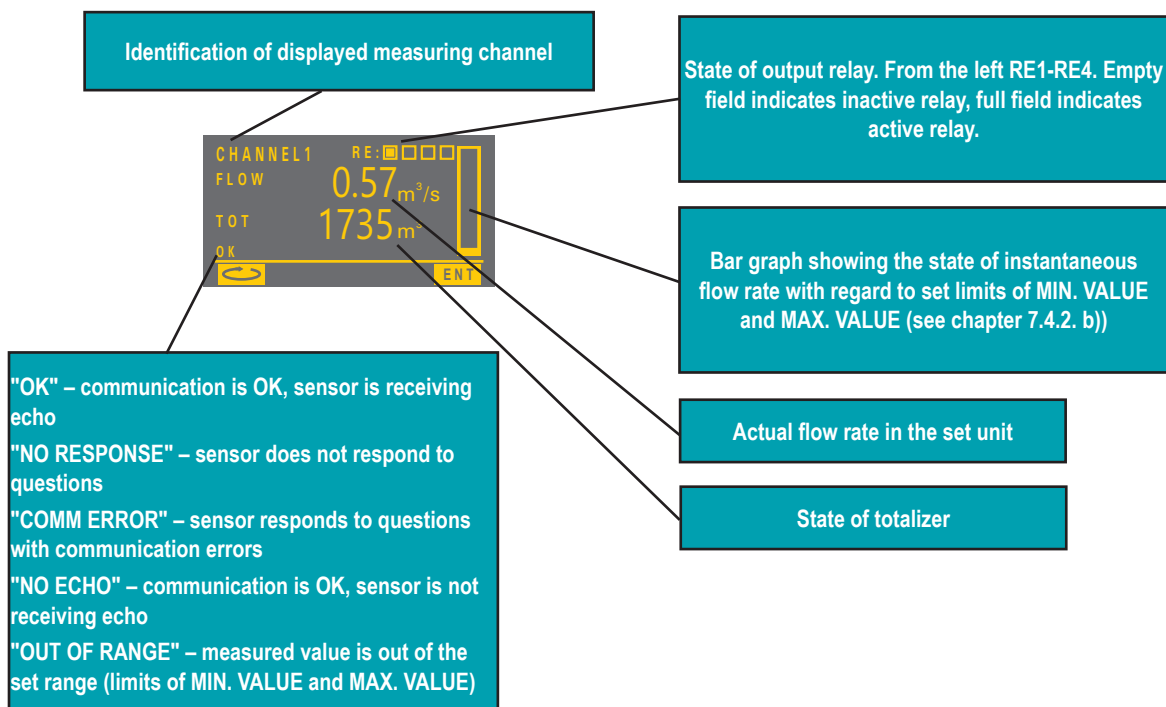









On the FLOW type screen, only the actual flow rate is shown. Graphical appearance of this screen is as follows:

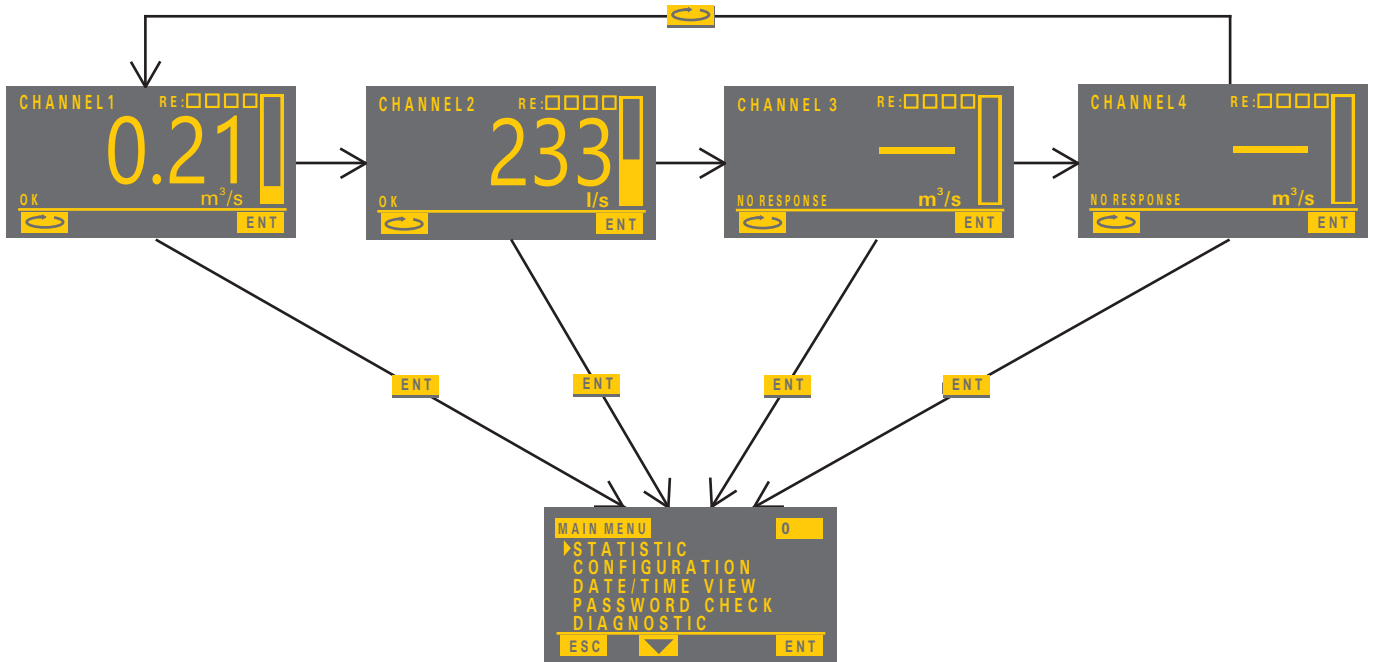

By pressing the button  repeatedly, measuring channels with enabled visualisation can be switched (see chapter 1.2.2h).

By pressing the button , you will return to the basic menu of the equipment. By pressing the button  you will return to the main screen.



You can navigate in menu using buttons  and . By pressing the button , you enter to a submenu, and by pressing the button  you will return to the previous menu.

In menu in the upper part of the screen, name of superior item is displayed, including the menu identification number. Each menu has its unique identification number.

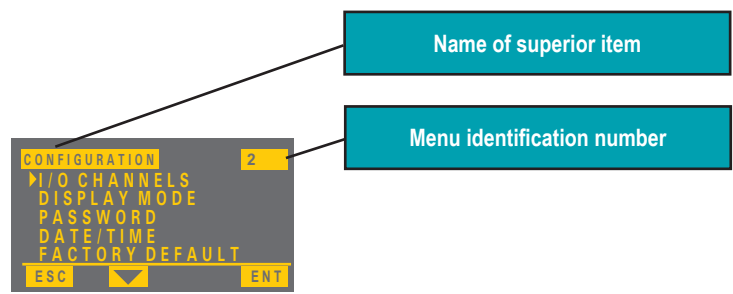

### 8.3. LOCKING / UNLOCKING CONFIGURATION MENU OF THE EVALUATION UNIT

Complete configuration of the evaluation unit can be made in the CONFIGURATION menu within the main menu (MAIN MENU). Access to this menu is only allowed to authorized persons, and therefore, this menu is protected by a 4-digit user password. In production, this password is set to a default "1234".

#### 8.3.1. UNLOCKING CONFIGURATION MENU OF THE EVALUATION UNIT

The configuration menu can be unlocked using a valid access password. The password can be entered right at the time of entering to the CONFIGURATION menu from the main menu, or in the PASSWORD CHECK item in the main menu. For the purpose of entering the password, "INSERT PASSWORD?" text is displayed on the display.

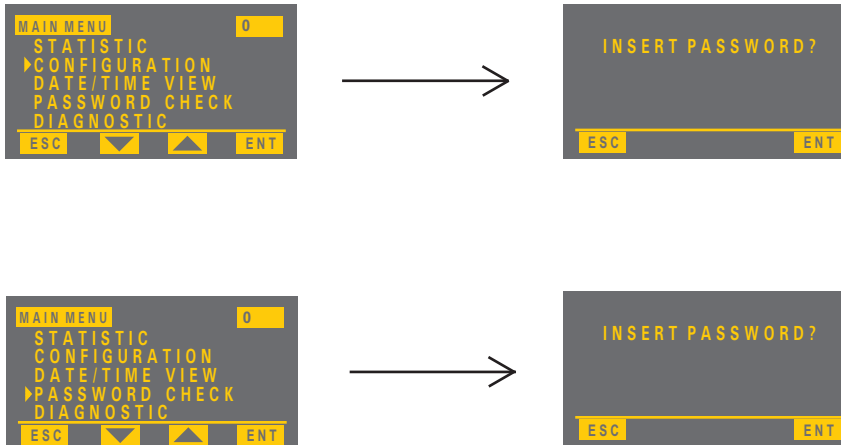

By pressing the button **ESC** you return to the previous menu, and by pressing the button **ENT**, the access password screen is displayed. The default password is "0000". By pressing the button **↔**, positions can be browsed. Current position is highlighted. By pressing the button **↵**, numbers to the current position can be entered in the range of 0 to 9. By pressing the button, the password is confirmed.



When the password is entered incorrectly, "INCORRECT" text is displayed, and by pressing the button **ESC** the text "INSERT PASSWORD" is displayed again to enter the password or return to the previous menu.



When the entered password is correct, by pressing the button **ENT** the configuration is unlocked. When the password was entered at the time of entering to the CONFIGURATION menu, this menu will be accessed. When the password was entered in the PASSWORD CHECK item, you will return to the main menu. Then, for the access to the CONFIGURE menu, you will not need to enter the password. If the device is inactive for 10 minutes, it will automatically return to the main screen lock the unit.

### 8.3.2. LOCKING CONFIGURATION MENU OF THE EVALUATION UNIT

The configuration menu can be locked in PASSWORD CHECK item in the main menu. For the purpose of entering the user password, "INSERT PASSWORD?" text is displayed on the display. By pressing the button **ESC** you will return to the previous menu, and by pressing the button **ENT**, a field to enter the password will show. To lock the configuration menu, leave the value of "0000" and confirm using the button **ENT**. "INCORRECT" text shows on the display, and access to the unit's configuration menu is locked.

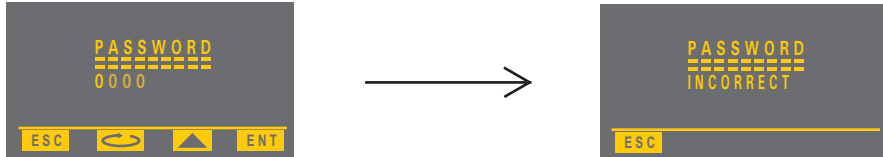

By pressing the button **ESC** you will return to the main menu.

### 8.4. CONFIGURATION OF THE EVALUATION UNIT

In the CONFIGURATION menu, you can completely configure particular measuring channels, change user's password, set internal date and time, and restore the device to the factory default.

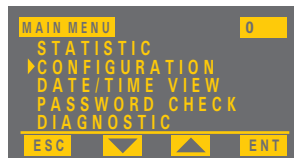

#### 8.4.1. PAIRING MEASURING SENSORS WITH THE EVALUATION UNIT

The following description is applicable to sensor configuration in the measuring channel 1. Configuration of other channels is identical. When connecting multiple sensors, they must be connected one by one. At first, connect the first sensor and configure it. Then, connect another sensor and configure it, etc. When connecting all the sensors at once, there is a risk for the sensors to have identical default address, resulting in communication collisions. In the CONFIGURATION/IO CHANNELS/INPUT CHANNELS/CHANNEL 1 menu, select ADDRESS, and set the measuring channel address identical with the sensor address (in the factory default setting, the ULM-53L sensor has address 0x01).

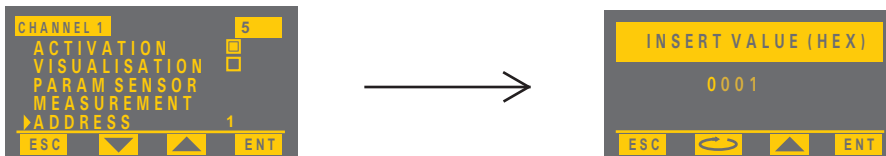

In the same menu, you can activate the ACTIVATION item by pressing the button **ENT**. If the item is active, there is a symbol  shown next to it. Otherwise, only the symbol  is shown next to it. By activation of this item, communication between the evaluation unit and sensor is established. Channels with no connected sensors shall remain inactive.



a) Automatic parametrization of sensor

Automatic parametrization of the sensor is used to set basic sensor parameters for its correct operation with the evaluation unit. In the CONFIGURATION/IO CHANNELS/INPUT CHANNELS/CHANNEL 1/PARAM SENSOR menu, select the AUTOSET item.



After activation of this item, the sensor is automatically set. The configuration in progress is indicated with the "WRITING" text. After the configuration is successfully completed, "WRITE OK" is displayed.





In case the communication was not successful, "WRITE ERROR" is displayed.



By pressing the button **ESC** you will return to the previous menu. The communication error may be caused by wrong connection of the sensor, or by wrong setting of the sensor address.

b) Sensor to flume bottom distance setup

In the CONFIGURATION/IO CHANNELS/INPUT CHANNELS/CHANNEL 1/PARAM SENSOR menu, select SENSOR DISTANCE, and set the distance of the sensor from the measuring flume bottom. The distance is set in meters with four decimal digits. By pressing the button , positions can be browsed. Current position is highlighted. By pressing the button , numbers to the current position can be entered in the range of 0 to 9. By pressing the button **ENT**, set distance to sensor is confirmed and saved.

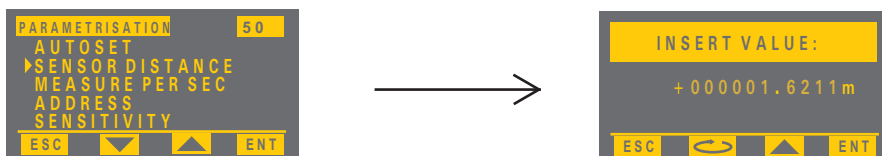

After the write operation is successfully completed, "WRITE OK" is displayed. By pressing the button **ESC** you will return to the previous menu.



### c) Setup of number of sensor measurements per second

Then, in the CONFIGURATION/IO CHANNELS/INPUT CHANNELS/CHANNEL 1/PARAM SENSOR menu, select MEASURE PER SEC item, and set the number of sensor measurements per second (1-5).

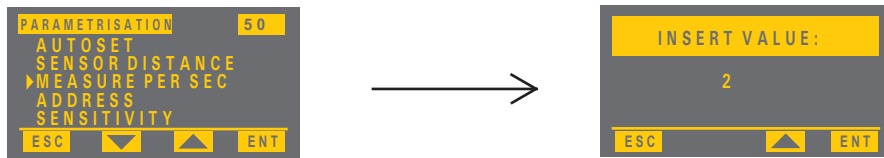

After the write operation is successfully completed, "WRITE OK" is displayed. In case any values out of range are entered (1-5 allowed), "WRITE ERROR" is displayed. By pressing the button **ESC** you will return to the previous menu.

### d) Sensor internal address setup

In the CONFIGURATION/IO CHANNELS/INPUT CHANNELS/CHANNEL 1/PARAM SENSOR menu, select ADDRESS, and set the new address of the sensor. Set the address in the range of 0x01 to 0xF7 (247 in decimal system). After the successful write operation completion, "WRITE OK" is displayed again. By pressing the button **ESC** you will return to the previous menu.

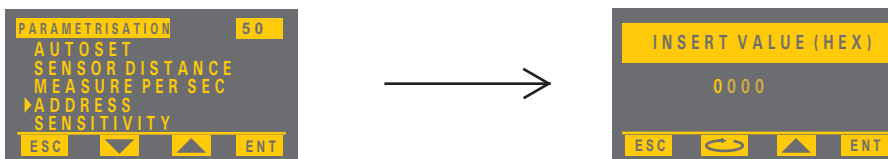

Since the internal address of the sensor is changed, the measuring channel address must be changed, too. In the CONFIGURATION/IO CHANNELS/INPUT CHANNELS/CHANNEL 1 menu, select ADDRESS, and set the address.



Thus, the sensor parametrization is finished.

### e) Sensor sensitivity setup

Then, in the CONFIGURATION/IO CHANNELS/INPUT CHANNELS/CHANNEL 1/PARAM SENSOR menu, select SENSITIVITY, and select HIGH or LOW sensitivity.

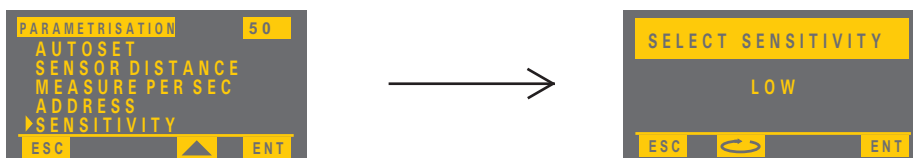

### f) Communication with sensor state check up

Check the communication and measurement state in the DIAGNOSTIC item in the main menu.

Select required channel using button **↶**, and check the sensor for its communication with the evaluation unit.

The communication state is expressed by one of five messages in the left lower corner of the display:

- OK... communication is OK, sensor is receiving echo
- COMM ERROR...sensor responds to questions with communication errors
- NO RESPONSE... sensor does not respond to questions
- NO ECHO...communication is OK, sensor is not receiving echo
- OUT OF RANGE... measured value is out of the set range (limits of MIN. VALUE and MAX. VALUE)

In case of multiple connected sensors, repeat the procedure in chapter 7.4.1. for each of the connected sensors (CHANNEL 1 to CHANNEL 4).



## 8.4.2. FLOW RATE MEASURING CHANNEL SETUP

The following description is applicable to the evaluation unit configuration in the measuring channel 1. Configuration of other channels is identical.

### a) Flow rate unit of measure setup

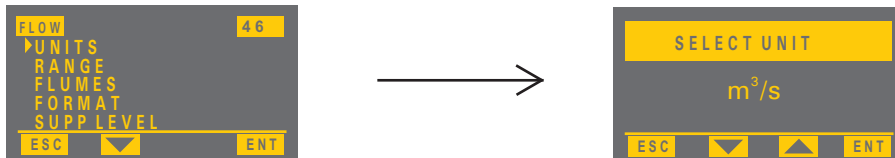
In the CONFIGURATION/IO CHANNELS/INPUT CHANNELS/CHANNEL 1/MEASUREMENT/ FLOW menu, select UNITS, and set the required flow rate unit of measure.



Using  and  buttons, required unit of measure can be selected. When the  button is pressed, the set unit of measure is saved, and you will return to the previous menu.

### b) Measured flow rate range setup

In the same menu, select RANGE, and in the MIN.VALUE and MAX.VALUE menu, set the minimum and maximum value for the flow rate. The value is set in the physical unit of measure set in the previous item a).

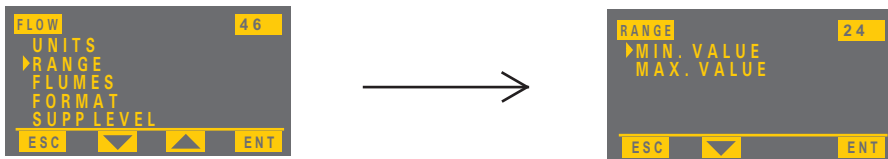

These values are used to graphically show the flow rate in the bar graph (see chapter 7.2) and to verify the limits of the measured flow rate. In case these limits are exceeded, the measurement is stopped and an error is indicated by "OUT OF RANGE" message (see chapter 7.2)

### c) Consumption curve setup

In the CONFIGURATION/IO CHANNELS/INPUT CHANNELS/CHANNEL 1/MEASUREMENT/ FLOW menu, select FLUMES.



The measured height of the level can be recalculated to the flow rate using a pre-defined P1 to P9 consumption curves for Parshall's flumes, or by user defined consumption curve based on a formula.

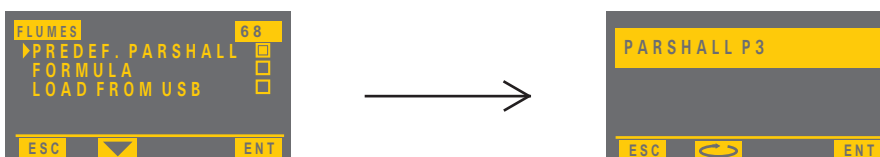

In case of pre-defined Parshall's flumes, select PREDEF. PARSHALL.

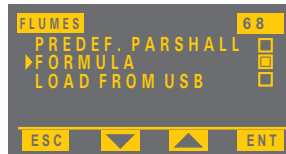

Using  button, select required flume type, and using  button, confirm, and return to the previous menu.

In case of user defined curve, select FORMULA.



Then, using  button, select required formula for the consumption curve the SELECT FORMULA menu, and by pressing the  button, confirm and return to the previous menu.

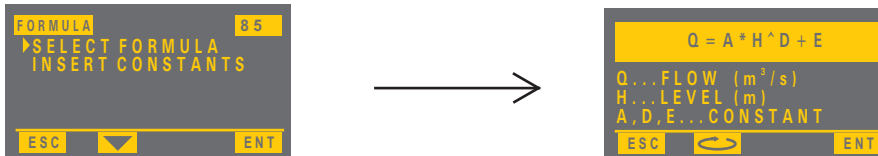

In the INSERT CONSTANTS menu, define constants for the selected formula.

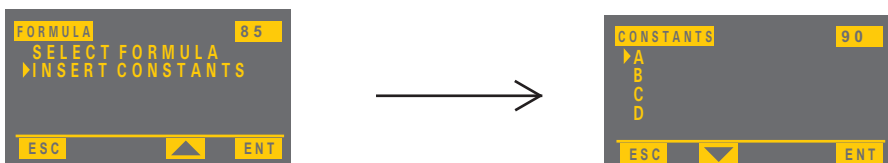

In case of user defined curve using a table, select LOAD FROM USB.

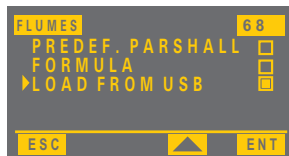

When the  button is pressed, a table is loaded to the internal memory of the evaluation unit.

Table definition:

- File name and format: data.csv
- Column delimiter: semicolon
- Left column: level height in meters
- Right column: flow rate in m³/s
- Format of values: decimal number, decimal part separated with point
- Maximum number of curve points (table rows): 128

d) Measured flow rate format setup (number of decimal points)

In the CONFIGURATION/IO CHANNELS/INPUT CHANNELS/CHANNEL 1/MEASUREMENT/ FLOW menu, select FORMAT.

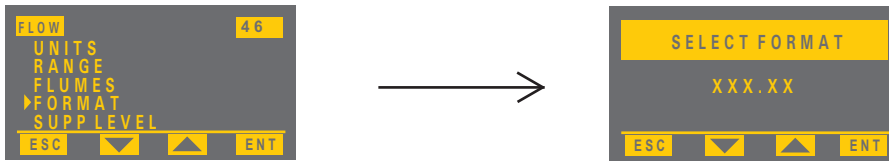

Using  buttons, select required number of decimal points. Using this format, the measured value will be displayed on the main screen (see chapter 7.2). In case the range is exceeded, "-----" symbols are displayed.

e) Small flow suppression setup

Select SUPP LEVEL in the same menu. This item is used to suppress small flow rate values. Until the set level height is not reached, zero flow rate will be indicated. The level height is set in meters with four decimal digits.

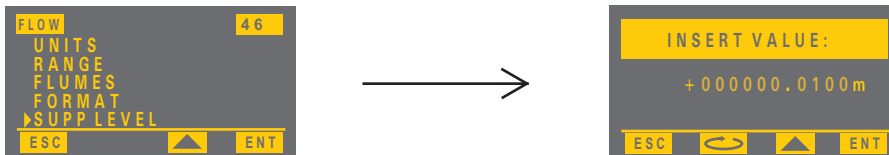

f) Echo loss maximum time setup

In the CONFIGURATION/IO CHANNELS/INPUT CHANNELS/CHANNEL 1 menu, select ERROR ECHO and set the maximum time of the loss of echo (0-99 s).

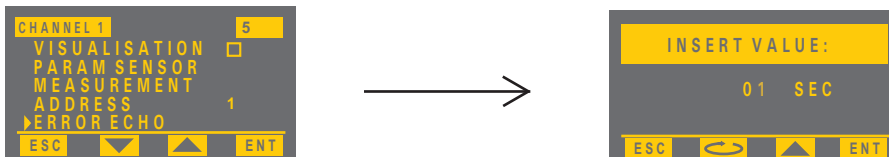



In case the sensor fails to receive echo for a longer time than the set time, this loss is evaluated as a failure state. This state is indicated on the main screen.

g) Measurement response time setup

This function is useful for the suppression of variations during fast or step changes in the level height (turbid level). The consequent measurement response time will be longer, and the evaluation unit will respond to fast changes with defined delay in seconds.

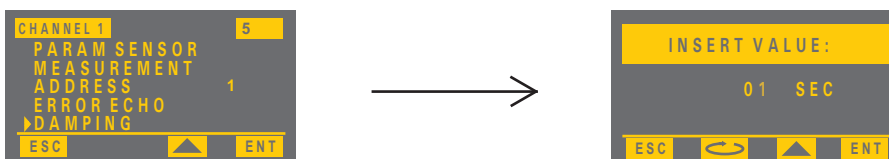

Select DAMPING in the same menu, and set required measurement response time (0.0 – 9.9 s).



When the  button is pressed, the set unit of measure is saved, and you will return to the previous menu.



#### h) Enabling visualisation of the measuring channel on the main screen

When the measuring channel visualisation is enabled, the channel can be displayed on the main screen (see chapter 1.1). The channel visualisation on the main screen can be enabled using **ENT** button next to the VISUALISATION. If the item is active, there is a symbol  shown next to it. Otherwise, only the symbol  is shown next to it.



### 8.4.3. RELAY OUTPUT SETUP

Relay outputs can be set in CONFIGURATION/IO CHANNELS/RELAYS menu.



Select RELAY1 to RELAY4 items to set the configuration of relays.

Each relay can work in several modes:

- Direct manual control
- Alarm function
- Pulse output function

Using the DIRECT MANUAL item, the relay can be controlled manually.

If you set maximum flow rate value in the ALARM item, you enter to the alarm function. When this value is exceeded, appropriate relay is activated.

When you set WIDTH PULSE and QUANTITY values in the PULSE OUTPUT item, you enter to the pulse output mode. In the WIDTH PULSE item, you can set the pulse width from 0.1 to 9.9 s. In the QUANTITY item, you can set flow amount to generate the pulse.

In the INVERT item, you can select whether the relay is in normal mode (active relay – switched on, inactive – switched off), or in the inverse mode (active relay – switched off, inactive – switched on).

In the SOURCE item, you can select a channel the relay function is associated with.

### 8.4.4. NETWORK INTERFACE SETUP

The network interface setup is only for FCU-400-R\_-W version. The network interface setup can completely be done using a web interface.

### 8.4.5. BINARY INPUT SETUP

Binary inputs can be set in CONFIGURATION/IO CHANNELS/BINARY INPUT. In this menu, you can select a user totalizer to be reset to zero during the activation of the binary input. Make the selection by pressing the **ENT** button next the required item. See more about totalizers in chapter 7.5.2

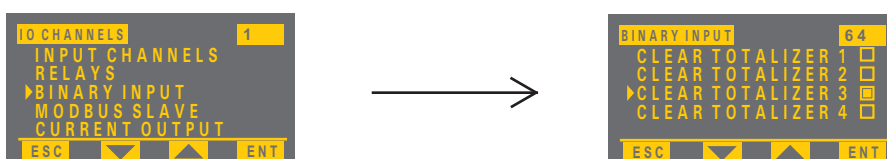

### 8.4.6. COMMUNICATION PARAMETERS SETUP FOR MODBUS RTU / RS-485 SLAVE

Complete setup of RS-485 line communication parameters and device address in the Modbus RTU(Slave) protocol can be made in the CONFIGURATION/IO CHANNELS/MODBUS SLAVE menu.

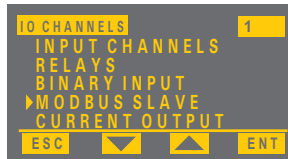

#### a) Communication rate setup

The communication rate can be set in the BAUD RATE menu.

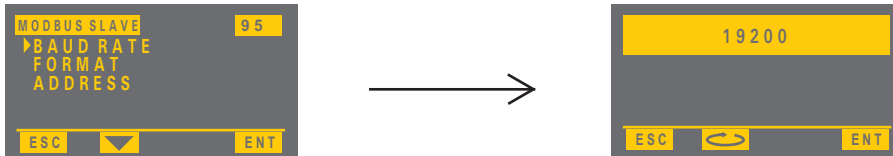

Select the required communication rate using button from values of 4200, 9600, 19200, and 38400 Bd/s. When the button is pressed, selected communication rate is saved, and you will return to the previous menu. When you press button, you will return to the previous menu without saving the setup.

#### b) Communication format setup

The communication format can be set in the FORMAT mode.

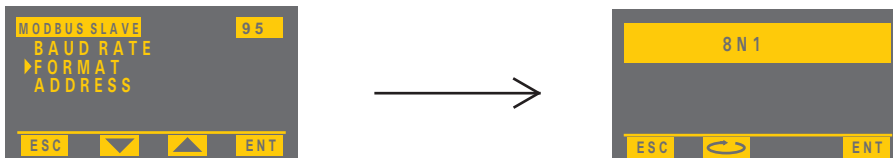

You can select required format using button from 8N1, 8N2, 8E1, 8E2, 8O1, and 8O2 types. When the button is pressed, selected communication format is saved, and you will return to the previous menu. When you press the button, you will return to the previous menu without saving the setup.

#### c) Device Modbus address setup

The Modbus address of the device can be set in the ADDRESS menu.

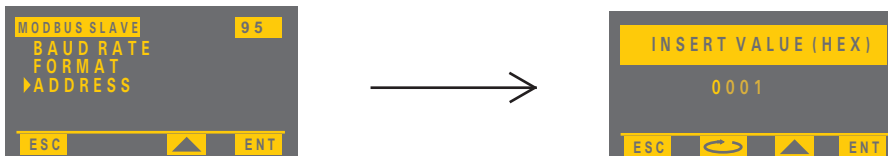

You can select required address from 0x01 to 0xF7(247 dec). When the button is pressed, the set address is saved, and you will return to the previous menu. When you press the button, you will return to the previous menu without saving the setup.

### 8.4.7. CURRENT OUTPUT PARAMETERS SETUP

Complete current output parameters can be set in CONFIGURATION/IO CHANNELS/CURRENT OUTPUT menu.



#### a) Minimum flow rate setup

Minimum flow rate corresponding to the minimum current at the output can be set in the MIN FLOW item.

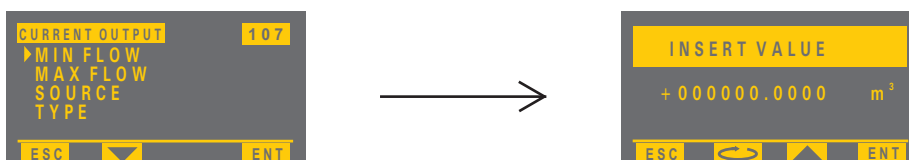

a) Maximum flow rate setup

Maximum flow rate corresponding to the maximum current at the output can be set in the MAX FLOW item.

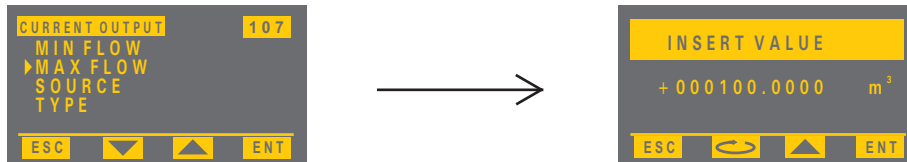

c) Source channel setup

The SOURCE item is used to set the source channel, the current output is associated with.

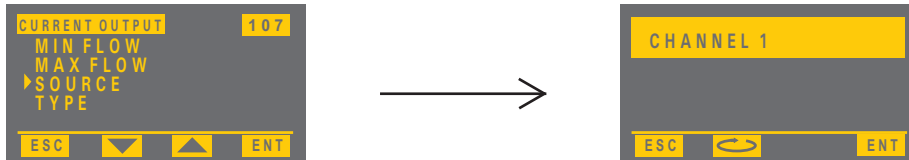

d) Current output type setup

The current output type can be selected in the TYPE item. You can select between the scope of 0-20 mA, and 4-20 mA, with current error of 3.75 mA or 22 mA.

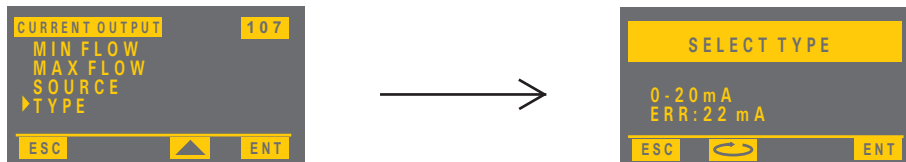

**8.4.8. GENERAL SETTINGS**

a) Main screen type setup

The main screen type can be set in CONFIGURATION/DISPLAY MODE menu.

When you access this item, you can select from two displays: FLOW, or FLOW+TOTALIZER.

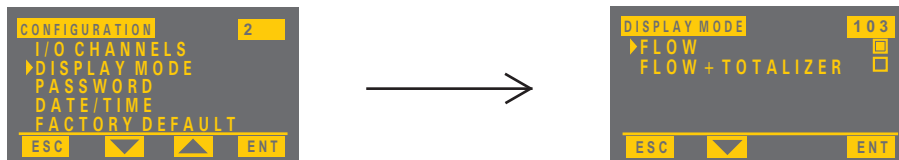

When you select the FLOW item, actual flow rate is displayed on the screen.



When you select the FLOW+TOTALIZER item, actual flow rate is displayed on the screen together with the totalizer state.



b) Access password change

The access password can be changed in the CONFIGURATION/PASSWORD menu.

When you enter this item, you are asked to re-enter your user password.

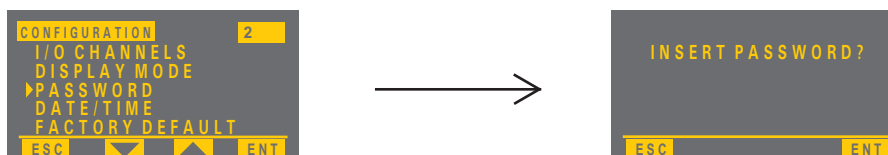

When the password is entered incorrectly, "INCORRECT" text is displayed, and by pressing the button **ESC** "INSERT PASSWORD" text is displayed again to enter the password or return to the previous menu. When you enter correct password, a field for the access password change shows up with the existing password as its default. By pressing the **↶** button, numbers can be browsed. Current position is highlighted. By pressing the **▼** button, numbers to the current position can be entered in the range of 0 to 9. By pressing the button **ENT**, the password is confirmed.



### c) Date and time setup

Date and time can be changed in the CONFIGURE/DATE-TIME menu. When you access this item, current date and time are displayed. By pressing the button **↶**, positions can be browsed. Current position is highlighted. By pressing the **▼** button, number to the current position can be set. By pressing the button **ENT**, date and time are confirmed. At the moment you press the button, second counter is reset to zero.

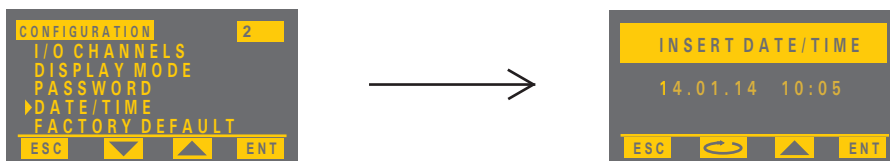

### d) Restoring the evaluation unit to the factory default

The factory defaults can be restored in the CONFIGURE/FACTORY DEFAULT menu. When you access this item, "ARE YOU SURE?" shows on the display. By pressing the button **ESC** you will return to the previous menu. By pressing the button **ENT**, the factory defaults will load, and you will return to the previous menu.

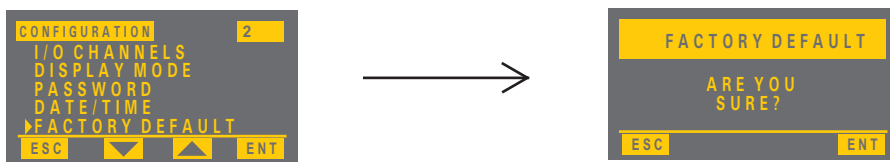

After the activation of this function, all parameters of the unit are restored to the default state (including access password). Records of statistics, totalizers and operating hours remain unchanged!!!

## 8.5. READING STATISTICAL DATA

The FCU-400 evaluation unit is equipped with internal FLASH memory for storing average 5-minute flow rate values regularly from all channels. In addition to these average flow rate values, each channel's operating hours are stored in the FRAM memory as well as zero non-resettable counters of the total flown amount in each channel, so called totalizers.

### 8.5.1. RECORDING AVERAGE 5-MINUTE FLOW RATE VALUES

Each record of average 5-minute flow rate values includes date and time of the record, flow rate value with corresponding set unit and, measurement time within the relevant 5-minute section (in seconds). These values are stored for all channels. Thus, evaluation unit allows for browsing flow history up to the last 15 months.

These records can be read in three ways:

#### a) On the display

In the STATISTIC/VIEW STATISTIC menu, select 5-MIN FLOW item. After you access this item, enter required record date and time, you want to show on the display. Time can only be entered as a required hour.



After you press the **ENT** button, required record is searched for. During the search, the upper part of the display shows text "LOADING...". When the required record is found, it is shown on the display. Then, the first found record for the set hour shows on the display.

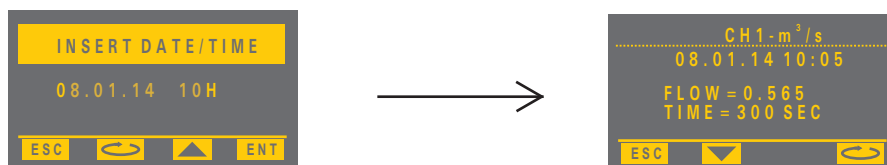

The record mentioned above had the following meaning:

On January 8 2014, within the period of time 10:00 – 10:05, the average flow rate in channel 1 was 0.565 m<sup>3</sup>/s. The measurement took place for 300 s, i.e. 5 minutes. During this 5-minute record, no measurement error occurred.

To move to the next record, please, use the **▼** button. To display recorded data for other channels, please, use the button **↶**.

When no record is found, "NOT FOUND" shows on the display.



By pressing the button **ESC** you can return to the previous menu.

#### b) Copying all records to USB Flash Disk

In the STATISTIC menu, select COPY STAT. TO USB item. When you access this item, you are prompted to insert the USB Flash Disk to USB connector.

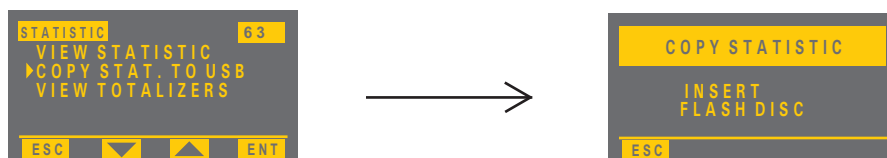

When the disk is inserted, all records are copied to the portable medium. During copying, per cent progress is shown on the display.



This action can be cancelled any time by pressing the button **ESC**. When the copying is completed, "COMPLETED" shows on the display.



When you remove the USB disk without proper completion, the stored file may be damaged. Copied data is stored in the CSV format file named FCU400.csv.

#### c) Reading records using RS-485 Modbus RTU-Slave communication channel

Any recorded data can be read using the RS-485 communication interface with Modbus RTU-Slave protocol.

## 8.5.2. FUNCTION OF TOTALIZER AND OPERATING HOURS

For each measuring channel, the evaluation unit includes two flown amount counters - totalizers. The first (factory) totalizer is used to count flown amount during the device lifetime, and cannot be reset to zero. The second totalizer (user) is used to count the flown amount, and can be reset to zero. These user totalizers can be reset to zero directly in menu, or by a connected button to binary input (see chapter 7.4.5)

Totalizers and operating hours can be displayed in the STATISTIC/IEW TOTALIZERS menu. When you access this menu, channel 1 factory totalizer and channel 1 operating hours are displayed.

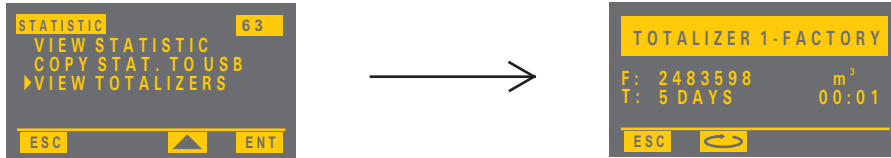

By pressing the  button, channel 1 user totalizer is shown, resettable to zero using the  button.

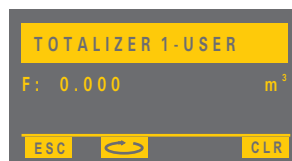



By pressing the  button again, you can browse all totalizers for all channels.

## 8.6. OTHER INFORMATION

### 8.6.1. DISPLAYING CURRENT DATE AND TIME

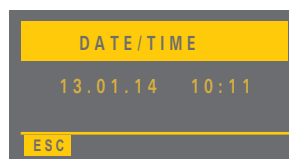
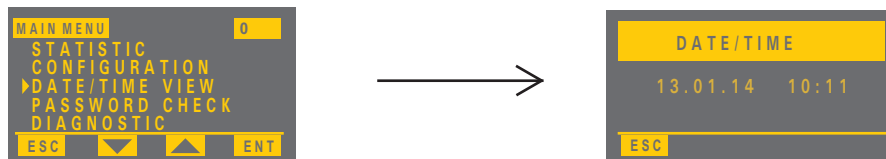
Current date and time can be displayed in the main menu under the DATE/TIME VIEW item.



By pressing the  button, you will return to the main menu.

### 8.6.2. DISPLAYING INFORMATION ABOUT THE EVALUATION UNIT

Information about the FCU-400 evaluation unit can be displayed in the main menu under the INFO item.

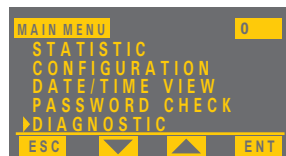

When you access this item, the evaluation unit type, serial number, and firmware version number are displayed. By pressing the button  button, you will return to the main menu.



**After the unit setup completion, it is recommended to RESET (CONFIGURATION / RESET), and verify correctness of preset parameters!**

## 9. MARKING METHODS

FCU-400-R  -  -

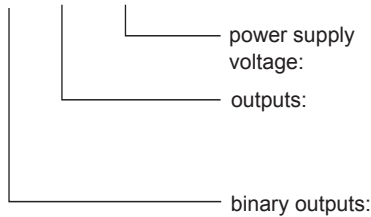

**230V** – 100 .. 240V AC

**24V** – 9.. 36V DC

**0** – without web server and without current output

**W**– web server

**I** – current output

**0** – 0x without relay outputs

**2** – 2x SSR relay outputs (RE 1 and RE 2)

**4** – 4x SSR relay outputs (RE 1 to RE 4)

## 10. EXAMPLES OF CORRECT MARKING

FCU-400-R4-W-24

(R4) SSR relay outputs; (W) including web server; (24V) power supply voltage 9 .. 36V DC.

FCU-400-R0-0-230

(R0) without relay outputs; (0) without web server, and without current output; (230V) power supply voltage 100 .. 240V AC.

## 12. PROTECTION, SAFETY, AND COMPATIBILITY

Both power supply version of the unit are protected with internal fuse.

Electric equipment of protection class II. Electric safety as per ČSN EN 61010-1.

Electromagnetic compatibility (EMC) is ensured in compliance with ČSN EN 55022 a ČSN EN 61000-4-2, -3, -4, -5, -6 -11 standards

## 11. USAGE, OPERATION, AND MAINTENANCE

The flowmeter does not require any operating personnel. During operation, the technological part operating personnel is informed about the liquid flown amount using a consequent display device and at the place of the flowmeter installation.

The maintenance of the device is based on the flowmeter and supply cable undamaged state inspection. Depending on nature of measured liquid, it is recommended every one year to inspect cleanliness of internal measuring electrodes, and clean them as needed. When any visible defects are detected, promptly contact manufacturer or dealer of the equipment.



No modifications or interventions to the FCU-400 flowmeter are allowed without the manufacturer's approval. Repairs, if any, shall only be done at the manufacturer or authorized service organization.

Assembly, installation, commissioning, and maintenance of the FCU-400 flowmeter shall be performed in compliance with this user's guide, and applicable standards for the installation of electric equipment shall be observed.

## 13. MARKING LABELS

Flowmeter sensor label data **FCU-400-R\_-\_-230V**

manufacturer mark: Dinel® logo

internet address: www.dinel.cz

flowmeter type: FCU-400-R\_-\_-230V

product serial number: Ser. No.: xxxxx – (from the left: year of production, consequential serial number)

power supply voltage: U = 100 .. 240 V AC / 50 .. 60 Hz

nominal input power: P = 10 VA

working temperature range: t<sub>a</sub> = -30 ... +50 °C

sensor coverage: IP65



double insulation mark (protection class II device):

conformity mark: **CE**

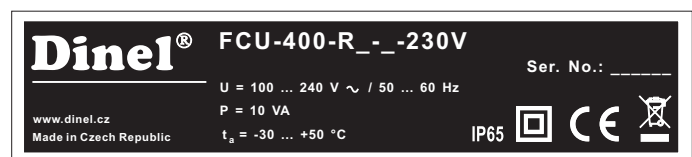
electric waste return mark:



## Flowmeter sensor label data FCU-400-R\_-\_-24V

manufacturer mark: Dinel® logo  
 internet address: www.dinel.cz  
 flowmeter type: FCU-400-R\_-\_-24V  
 product serial number: Ser. No.: xxxxx – (from the left: year of production, consequential serial number)  
 power supply voltage:  $U = 9 \dots 36 \text{ V DC}$   
 nominal input power:  $P = 8 \text{ VA}$   
 working temperature range:  $t_a = -30 \dots +50 \text{ °C}$   
 sensor coverage: IP65  
 double insulation mark (protection class II device):   
 conformity mark:   
 electric waste return mark: 

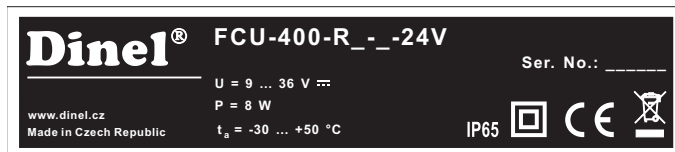

## 14. SPECIFICATIONS

BASIC SPECIFICATIONS		FCU-400
Case - material		ABS
Dimensions		160x166x106 mm
Protection class		IP65
Working temperature		-30 ... +60°C
Power supply voltage	230 V option 24 V option	100 - 240V AC 9 - 36V DC
Nominal input power	230 V option 24 V option	max. 10VA max. 8VA
Outputs		0, 2 or 4 SSR relays, max. 250 V AC / 100mA (24 V DC / 100mA) (alarm function, pulse output, manual control) RS 485 / Modbus RTU - Slave, galvanic separation Ethernet / RJ45 (optional) Current output 0/4 - 20 mA (optional)
Inputs		RS 485 / Modbus RTU - Master, galvanic separation (max. 4 sensors) Binary input for resetting user flow rate counter to zero (for voltage free contact) USB
Internal power supply source for sensors		$U_s = 24 \text{ V DC} / I_{max.} 120 \text{ mA}$
Type of display		Matrix OLED display, 128x64 pixels
Controls		Foil keyboard - 4 buttons
Internal memory capacity for data archiving		Continuous archiving of average 5-minute flow rate values for at least 15 month
Display functions		Display actual flow rate value with graphical representation in bar graph Simultaneously display actual flow rate, state of relay outputs and state totalizer
Totalizer function		2 counters of total flown amount in each channel (1x resettable, 1x non-resettable)



# **Dinel**<sup>®</sup>

industrial electronics

**Dinel, s.r.o.**

U Tescomy 249  
760 01 Zlín  
Czech Republic

Tel.: +420 577 002 003  
Fax: +420 577 002 007  
E-mail: [sale@dinel.cz](mailto:sale@dinel.cz)

**[www.dinel.cz](http://www.dinel.cz)**

The latest version of this instruction manual can be found at [www.dinel.cz](http://www.dinel.cz)

Version:6/2015