



PROGRAMMABLE CONTROL UNIT PCU-100

Firmware version 2.0.2. or higher



Before the first use of the unit, read the instructions in this manual and keep it carefully. The manufacturer reserves the right to do alteration without prior notice.

CONTENT

1. Basic description	4
2. Range of application	5
3. Variants of sensors	5
4. Dimensional drawings	5
5. The front panel and terminal block	6
6. Installation and putting into operation	6
7. Mechanical mounting	6
8. Electrical connection	7
9. Settings	10
9.1. Setting of the input channel in the unit	11
9.2. Display configuration	16
9.3. Conversion Rules	19
9.4. Output Relay	25
9.5. The archiving and data export configuration	27
9.6. Parametrization of connected measuring devices using the HART® protocol	28
9.7. Other settings of the control unit	37
9.8. Menu Structure	40
10. Functions of the device	44
10.1. Description of the front panel	44
10.2. Signalling functions	45
10.3. Export of data	45
10.4. Displaying Functions of the User Menu	46
10.5. Unit firmware updates	47
11. Order code	48
12. Correct specification examples	49
13. Safety, protection and compatibility	49
14. Use, manipulation and maintenance	49
15. General, conditions and warranty	50
16. Marking of labels	50
17. Technical specifications	51
18. Packing, shipping and storage	52

SYMBOLS USED

In order to ensure maximum safety of control processes, we have defined the following safety and information instructions. Each instruction is marked with a corresponding pictogram.



Caution, warning, danger

This symbol informs about particularly important instructions for the installation and operation of the device or dangerous situations that may occur during installation and operation. Ignoring these instructions may be the cause of the fault, damage to or destruction of the device or may cause damage to health.



Information

This symbol indicates particularly important device characteristics and recommendations.



Note

This symbol indicates the useful additional information.

SAFETY



All the operations described in these operating instructions must be made only by trained personnel or by an authorised person. Warranty and post-warranty repairs must be carried out exclusively at the manufacturer. Incorrect sensor use, assembly or configuration may cause accidents in the application (tank overfilling or damage to the system components).

The manufacturer is not responsible for the improper use, working losses incurred by either direct or indirect damage and the expenditure incurred during the installation or the use of the sensor.

1. BASIC DESCRIPTION

Programmable control unit PCU-100 is used for measurement, displaying and archiving of the physical value (liquid level, pressure, flow, temperature, etc.). One transducer of physical magnitude with an analogue 4-20 mA output can be connected to the unit.

Different types of conversion (converting) characteristics (linear, square, root and user defined), may be selected, also the tank dimensions for conversion to the volume of the media may be specified. The unit is also available in the version without graphic LCD display that is replaced with the status LEDs. The unit has a battery backed real-time circuit. Archiving with user-defined period takes place on the internal flash memory with a capacity sufficient for more than 500,000 samples. Data can be exported to a micro SD card for additional processing.

User configuration is possible through a regular desktop application after connecting a PC via a micro USB connector located on the front panel of the unit. For the version fitted with an LCD display the configuration is also possible using the graphical menu and four membrane keys.

The unit is equipped with one input settings in the hardware configuration according to the type of unit. One relay output is fully user-configurable, including the possibility of two-state control. The functionality of the unit is expandable with optional modules. The units are built into the ABS / PC instrument boxes intended for wall mounting. Connection terminal is located inside the device.

2. RANGE OF APPLICATION

Programmable control unit can be used as a universal industrial data logger for monitoring of a measured value. Thanks to a relay output, it is also possible to use the unit for the control of the process of measured value using two-state control.

3. VARIANTS OF SENSORS

The unit is available in two versions. The makes are different by the front panel appearance. Both versions have a micro USB connector to connect a computer to configure the unit via the configuration application and micro SD card slot for the purposes of exports of the recorded data.

- **PCU-100-D** **Front panel with a graphic LCD display and a membrane keypad.** The entry depending on configuration (for connecting one sensor), one relay output.
- **PCU-100-L** **The front panel without an LCD display with status LEDs.** The entry depending on configuration (for connecting one sensor), one relay output

4. DIMENSIONAL DRAWINGS

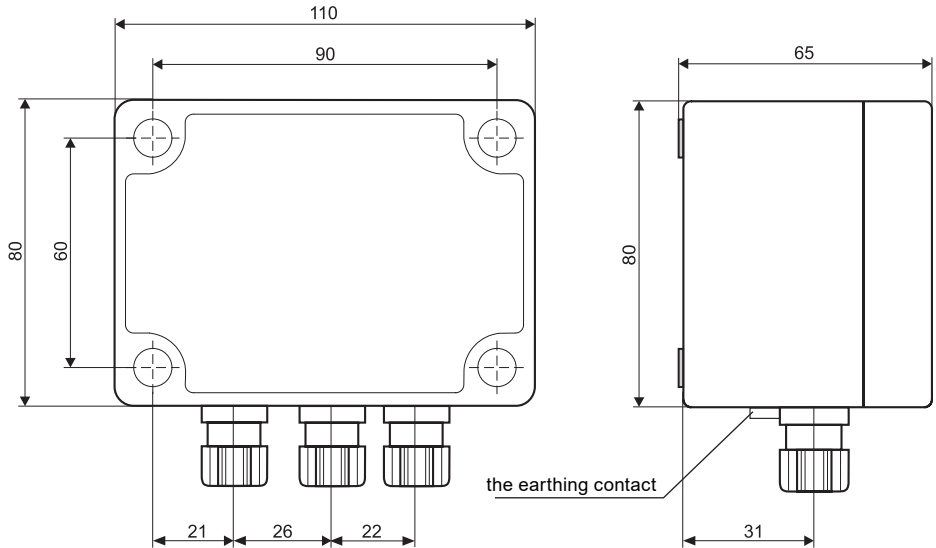

5. THE FRONT PANEL AND TERMINAL BLOCK

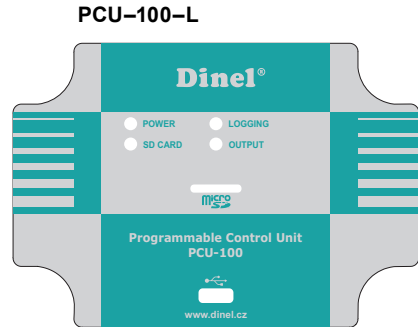
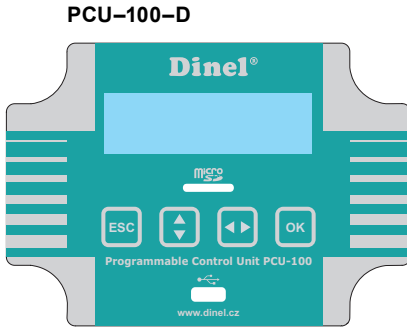

Terminal Block: PCU-100-_-I:

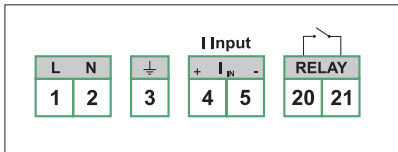

No. of terminal	
1	L (85 - 253 VAC)
2	N (85 - 253 VAC)
3	↕ Functional earthing
4	Current input +
5	Current input -
20	RE 1 (100 mA / 250 VAC)
21	RE 1 (100 mA / 250 VAC)

6. INSTALLATION AND PUTTING INTO OPERATION

This procedure has the following three steps:

- **MECHANICAL MOUNTING - SEE CHAPTER 7**
- **ELECTRICAL CONNECTION - SEE CHAPTER 8**
- **SETTINGS - SEE CHAPTER 9**

7. MECHANICAL MOUNTING

- A number of evaluation units PCU-100-_-I is designed to be installed on a wall using four mounting screws or bolts (hereinafter referred to as “the screws”).
- When installing the device, it is first necessary to withdraw the transparent polycarbonate housing of the front panel that is held in place by 4 plastic screws. The mounting holes designed for screws for attaching to the wall are located under the plastic screws. Using the screws, the unit is fixed in the required position on the wall. Now, it is possible to connect the cables to the terminals.
- Then, return the transparent cover to the place on the front panel and its plastic screws are sufficiently tightened to achieve full coverage.
- The prescribed tightening torque is 3 Nm.



Be extremely careful when placing the cover in place. It is not possible to settle the front cover arbitrarily, there are located protrusions on the bottom of the housing and on the body of the boxes. At bad settlement, these protrusions may prevent the full engagement of the seal and the achievement of full coverage.

8. ELECTRICAL CONNECTION

The electrical connection is made to the terminal block of the device. For an access to the terminal block, it is required:

1. Remove the transparent front polycarbonate housing (see chapter Mechanical assembly)
2. Grip the front panel on the sides by the grips intended for this purpose (see figure below)
3. Pull evenly on both sides to eject the front panel from the connector.

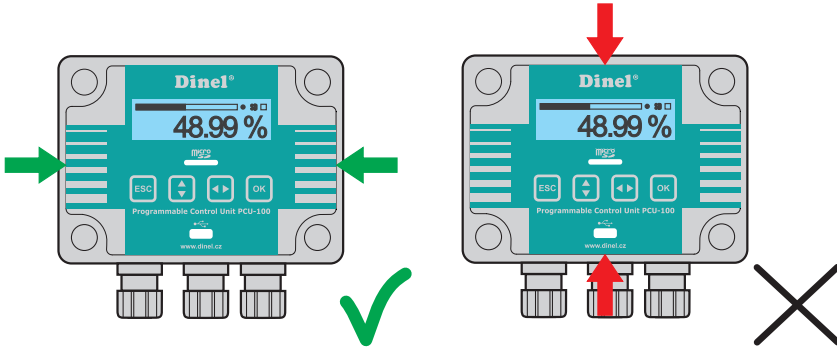

Electrical connection can only be made in a voltage-free state!

The temperature of the internal components of the unit may under specific conditions exceed a temperature of 60°C after a longer period of time in service. Take care when handling.

- The device may only be connected to the power supply via an easy to reach switch with marked turned off/on positions and must be protected by a fuse or circuit breaker with a value of max. 16 A!



The switch or circuit breaker used as the disconnect device must be in accordance with the IEC60947-1 and IEC60947-3, must be marked and must not be in the network inlet.

- The used connecting cables must be of circular cross-section of the prescribed diameter (2.5 - 6.5 mm). The connection cable must be according to the specifications of the manufacturer rated to the operating voltage (85 - 253 VAC) and the current load corresponding to the rated wattage (6 VA) at this voltage. The insulation material must comply with the operating voltage and endure the ambient temperatures of up to 70 °C. In the case, there is no cable in the penetration, the penetration must be fitted with a plug. Cable grommets must be tightened to the specified torque (3 Nm).

WIRING CONNECTIONS

Power supply inlet	power supply AC lead "L" to the terminal No.1 and lead "N" to the terminal No.2.
Connections of input device	current loop "+" to terminal No. 4 and "-" to No. 5
Relay output (galvanically separated solid state relay - SSR)	the connection to the terminals No.6 and No.7.



The external power supply is not connected

Grounding wire connected to the unit serves always as the functional ground to improve the assembly resistance against EM interference and does not fulfil the protective function. Connection of a functional earth to the unit is possible in one of the two ways while we are choosing the way that allows connection the ground wire on a shorter route:

1. We will connect the grounding wire inside the unit to the terminal number three where it is assumed to bring the earthing wire to the unit within the power cable.
2. The grounding wire will be connected to the external earth terminal of the device, which is located on the bottom of the box together with outlets.



The grounding wire is always attached only in one place by using the method 1 or 2. It is never attached in both places at the same time.

Example connection:

An example of the PCU-100-_-I unit connection with the level sensor ULM-53-_-I is shown here.

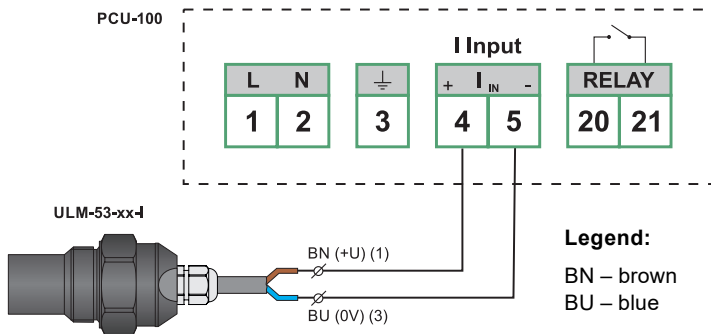

The level transmitter ULM-53-_-I may be replaced by any other measuring device with current output.

Example of a circuit with shielded cable:

An example of the PCU-100-_-I unit connection with the level sensor -HLM-35N-_K is shown here.

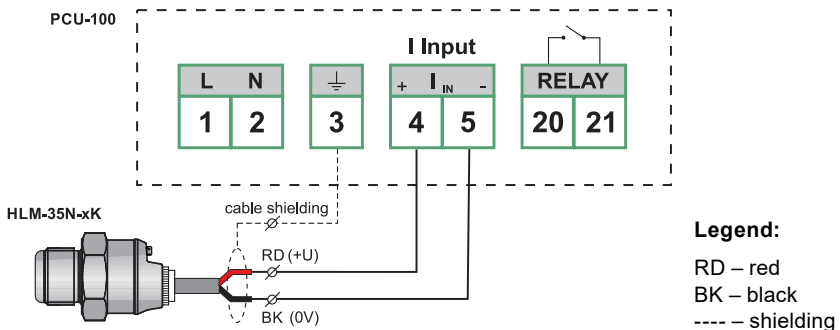

The example of several level meters connection with the HART® protocol support:

The example of the PCU-100-_-H unit connection with several ULM-70-N-_-_-I level meters is shown here.

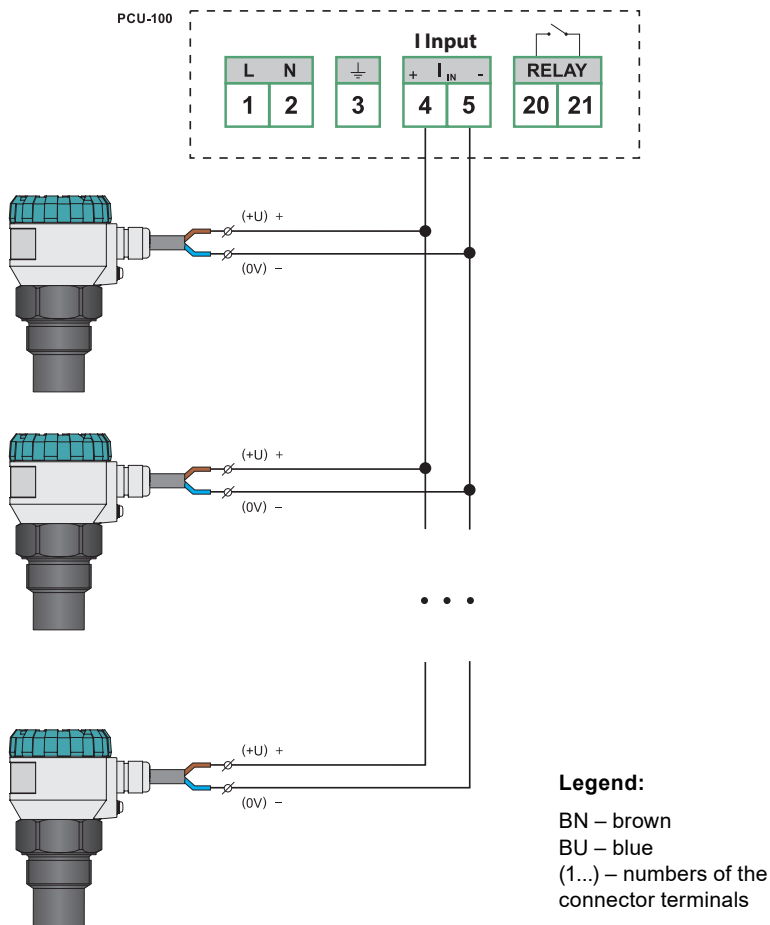

The ULM-70-N-_-_-I level meter can be replaced by any other measuring device with current output and the HART® protocol support (such as GRML-70 or CLM-70 from Dinel s.r.o.). The devices can also be combined and do not have to be of the same type.

It is important that the measuring devices are in the so-called multi drop mode. For level meters from Dinel s.r.o., this mode is set by changing the HART® polling address to other than 0. Regardless of the measured value, a constant current of 4 mA flows through the level meter and communication then proceeds only via the HART® protocol.



For correct functionality it is also necessary that all connected devices have different polling addresses (see chapter [reference to chapters 9.1.1 and 9.6.1]).

9. SETTINGS

The units in the version PCU–100-D with LCD display can be set using the graphical menu controlled by four membrane keys. For access to the control buttons and USB connector, it is necessary to withdraw first the transparent polycarbonate housing of the front panel that is held in place by 4 plastic screws. (see Chapter Mechanical mounting).



Be extremely careful when placing the cover back in place. It is not possible to settle the front cover arbitrarily, there are located protrusions on the bottom of the housing and on the body of the boxes. At bad settlement, these protrusions may prevent the full engagement of the seal and the achievement of full coverage.

The basic functions of buttons and their symbols



The symbol used in the manual: [ESC]

Functionality:

- The procedure in the menu one level up
- Change cancelling when editing



The symbol used in the manual: [↑↓]

Functionality:

- The shift in the menu
- Increase of the highlighted character value on the screen for entering the values



The symbol used in the manual: [←→]

Functionality:

- The shift in the menu
- Shift between the characters on the screen for entering the values
- Change the value of the check mark at the menu item
- Change the value on the screen with the values selection



The symbol used in the manual: [OK]

Functionality:

- Entering the main menu
- Entering the sub-menu
- Confirming changes when editing



If no key is pressed within 5 minutes in the menu, the unit automatically switches back to the display mode.

Entry to the menu and scrolling through the menus

The entry to the menu is performed by pressing the **[OK]** button. By pressing briefly the button **[↑]** we are moving in the sub-menu, we get to the next level by pressing **[OK]**. The edited data can be changed using the arrows **[↑]** **[↔]**. The changes are saved with the **[OK]** button, back to the main menu, we get by pressing the button **[ESC]**.

The unit can also be fully set up using a PC configuration application. To connect the unit to your computer, a micro USB connector on the front panel of the unit is used. PCU-100-L units that are not equipped with a display can only be parametrized using this application.



The Micro USB cable must be connected to the unit on the fly; it must not be connected before connecting the unit to the power supply.

The layout of the application is intuitive and respects the layout of the graphical menu of the unit (user manual). A more detailed description can be found in the user manual for the application.



The application is free to download at www.dinel.cz/download-1



9.1. SETTING OF THE INPUT CHANNEL IN THE UNIT

9.1.1. Measuring range setting of the input channel

For a correct display of bar graph and for the purpose of the transfer characteristics configuration it is necessary to specify the limits of the measuring range of the unit, thus, minimum value of the input magnitude (corresponds to 0 %) and its maximum value (corresponds to 100 %).



The measuring range can be also configured inversely, when minimum of the range corresponds to a greater level of the input value than the maximum of the range.

Deviation of values outside the measuring range is indicated on the display of the unit by the text "Below the range"/"Above the range". However, the conversion of the value for display and archiving takes place also within the limits of the extended measuring range, if configured. Outside the extended measuring range is logged and displayed the value -N/A (below the minimum) or +N/A (above the maximum).



The extended measuring range can be configured identically as the measuring range. In this way the unit behaves even if the limits of the extended measuring range of the configured senselessly (in the area of the measuring range or inverted).

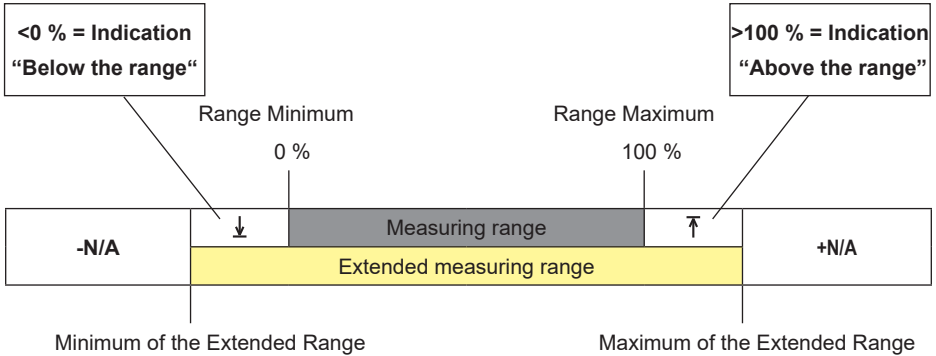

THE DEFAULT CONFIGURATION OF THE MEASURING RANGE ACCORDING TO THE UNIT'S INPUT

Type of unit inlet	Measuring range minimum	Measuring range maximum	Extended measuring range minimum	Extended measuring range maximum	Limits of the user configuration
Menu ID	028	029	030	031	–
Current	4 mA	20 mA	3.85 mA	20.55 mA	0 – 24 mA
HART®	4 mA / [-]	20 mA / [-]	3,85 mA / [-]	20,55 mA / [-]	neomezený

By factory default settings, HART® communication units (PCU-100-_-H-_-) operate with an analogue current value in the loop in mA (see chapter 9.1.3.). When the input is changed to a digital value, the measuring range limits are entered in the relevant physical units. Which were set on the measuring device.

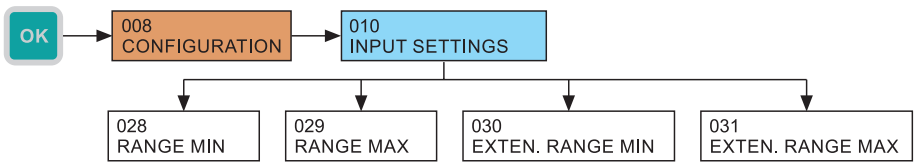

Example: The level meter GRLM-70N-10-_-I-_-E2000 is connected to the unit PCU-100-_-H-_-_. In case that we want to read the distance digitally to the level in millimetres, we set the MIN RANGE = 100 and MAX RANGE = 2000.

9.1.2. Filtration of the input channel

It is suitable to use the filtration function for suppression of the fluctuations in view at fast or jump changes of the input value. The subsequent speed of change of the input value will be dependent on an exponential course. Filtration with defined delay in seconds indicates the time that the exponential curve reaches 2/3 of its maximum value.



To turn off the filtration, it is necessary to configure the value to 0 seconds.

- **Menu: FILTRATION (ID 032)**
- **Default value: 20 sec**
- **Configuration range: 0-999 sec**
- **[↔] - Movement between the characters [↑] - Change of Value**



9.1.3. Type setting of the input channel



This setting is only available for units with the HART® input (PCU-100-_-H-_-).

Control units with the HART® communication input (PCU-100-_-H-_-) make it possible to work with a current value in the loop measured analogously or a digital value of the measured quantity read out using the HART® protocol. This communication is described in chapter (see chapter 9.6).

The following types of the input channel can be set for this unit:

- **Analogue**
The measured magnitude is read from the value of current in the current loop.
- **HART® – primary variable**
The measured magnitude is determined by the primary variable received from the measuring device.
- **HART® – secondary variable**
The measured magnitude is determined by the secondary variable received from the measuring device.
- **HART® – tertiary variable**
The measured magnitude is determined by the tertiary variable received from the measuring device.
- **HART® – quaternary variable**
The measured magnitude the quaternary variable received from the measuring device.



Primary, secondary, tertiary and quaternary variables are terms defined in the HART® protocol standard. Their values depend on the type of connected level meter. For ULM-54, ULM-70, GRLM-70, and CLM-70 level meters from Dinel s.r.o., the individual variables are described in chapter.

- **Menu: INPUT TYPE (ID 054)**
- **Default: Analogue**
- **[↔] - Selection of the measurement input source**



9.1.4. Type Setting of master (HART®)



This setting is only available for units with the HART® input (PCU-100-_-H-_-).

If the control unit is required to read the input magnitude digitally using the HART® protocol, it is necessary to check the configuration in which the PCU-100-H is connected to the other connected devices. The following 2 states can occur:

1. **The unit is connected only to measuring devices (flow meters, level meters, etc.) and no other HART® communicator is connected to the network.**
In this case, the unit should be set as the primary master.
2. **The unit is connected to measuring devices (flow meters, level meters, etc.) and another HART® communicator is connected to the network as well.**
In this case, it is necessary to set the PCU to the opposite master type than the HART® communicator. This means that if the connected HART® communicator is set as the primary master, the PCU must be set as the secondary master and vice versa.



Primary and secondary masters are terms defined in the HART® protocol standard. These are the devices that initiate communication with measuring devices. They actively query by commands and process the responses from measuring devices. The PCU-100-H unit is always in the master (primary or secondary) position, while the measuring devices are always in the slave position.

- **Menu: MASTER TYPE (ID 055)**
- **Default: Primary**
- **[↔] - The type selection of the master**



9.1.5. Polling address setting of the measuring device in the unit PCU



This setting is only available for units with the HART® input (PCU-100-_-H-_-).

By factory default settings, the polling address of the sensor with the HART® protocol support is set to 0. This setting is intended for the operation of the only sensor connected to the input of the unit (or any other master device in general). All digital communication then proceeds with this only sensor and the sensor also sets the loop current to its full extent depending on the measured quantity.

If several sensors are required to be connected to the unit (or any other master device in general), then these sensors must have polling addresses set in the range 1–15. In this setting, the sensor communicates just at this address, the current in the loop is fixed to 4 mA and the measured value is read only digitally using the HART® protocol.



Each of the connected devices must have a unique polling address

By setting the device's polling address to the unit, you specify the sensor with which the device should communicate. The sensor with the relevant polling address can then be parametrized (procedure in chapter 9.6.) or the digitally measured value can be read from it, see chapter 9.1.3.

- **Menu: DEVICE POLLING ADDRESS (ID 056)**
- **Default: 0**
- **Configuration range: 0-15**
- **[↑] - Value change**



9.2. DISPLAY CONFIGURATION

9.2.1. Types of the main screen display

The configuration of the main screen graphical style showing the measured value according to the user configuration. The configuration will affect the size of the digits, possible display of the bar graph, date and time. Detailed view is intended more as a diagnostic and, therefore, it shows the value of the input as well as user value with a fixed number of decimals.

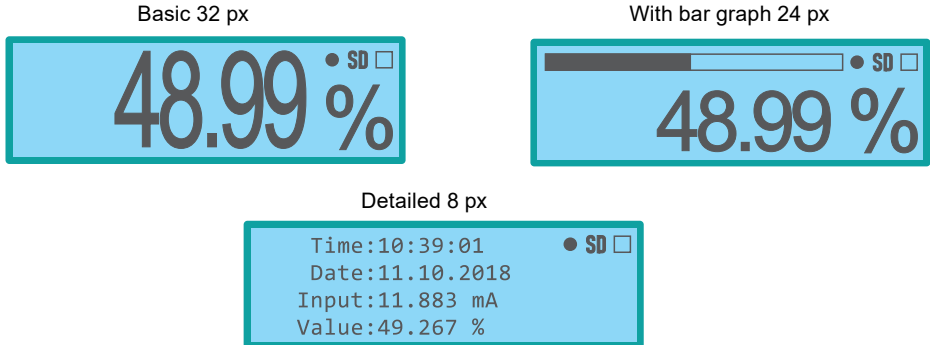

- **Menu: Main screen type (ID 020)**
- **Default: Basic 32 px**
- **[↔] - Change the display type**



9.2.2. Configuration of the display of decimal places' number

The configuration of a preferred number of decimal places on the main screen. The display takes place with a specified number of decimal places, if the amount of the value of the to display allows it with regard to the number of positions on the display. If there is not enough positions available for display, automatic reduction of the number of decimal places takes place.

The detailed display mode works with a fixed number of decimals and this configuration is not reflected.

- **Menu: DECIMAL PLACES ID (021)**
- **Default value: 2**
- **Configuration range: 0-5**
- **[↑↓] - Change of value**



9.2.3. Zeroes supplementation from the left-hand side of the displayed values

Causes displaying of zeros in free positions in front of the displayed value on the main screen.

- **Menu: ZEROES FROM LEFT (ID 022)**
- **Default value: prohibited**
- **The check mark - change by using [↔] directly in the menu (ID 009)**



9.2.4. Displayed physical unit

The physical unit for display on the main screen, the unit is not stored into the memory, to the head of the file with the exported data, there is given only the unit configured at the time of export. It can be selected out of seventeen predefined units + user-defined units.

PREDEFINED UNITS					
Dimensionless	[-]	Decimetres	dm	Cubic metres	m ³
Milliamperes	mA	Metres	m	Gallons	gal
Volts	V	Inches	in	Barrels	bbbl
Percentage	%	Feet	ft	Centigrades	°C
Millimetres	mm	Litres	l	Degree Fahrenheit	°F
Centimetres	cm	Hectolitres	hl	User-defined unit	????

- **Menu: DISPLAYED UNIT (ID 023)**
- **Default: Percentage**
- **[↔] - Changing the unit**



9.2.5. Defining the user unit

It is possible to enter any 4 characters. The here defined unit is then offered the selection of displayed physical units.

- **Menu: USER UNIT ID (024)**
- **[↔] - Movement between characters [↑] - Change of the character**



9.2.6. Menu language

The control unit allows to select a language mutations of the menu. Czech or English are available.

- **Menu: MENU LANGUAGE (ID 025)**
- **Default: English**
- **[↔] - Change of value**



9.2.7. Backlight level of the LCD display

Configuration of the LCD backlight level. It is possible to select from nine levels backlight and its full turn-off (0 value).

- **Menu: BACKLIGHT LEVEL (ID 026)**
- **Default value: 3**
- **Configuration range: 0 - 9**
- **[↑] - Change of value**



9.2.8. LCD display contrast

Configuration of LCD display contrast: Control electronics of the display uses automatic contrast correction according to the ambient temperature, therefore, in most cases there is no need of adjusting this configuration. However, in extreme cases, it is possible for the user to increase (positive values configuration) or decrease the contrast (negative value settings). The value can be configured in the range from -9 to +9.

- **Menu: CONTRAST (ID 027)**
- **Default value: 0**
- **Configuration range: -9 to 9**
- **[↑] - Change of value**



9.3. CONVERSION RULES

The control unit can convert the input value according to a mathematical curve, to a mathematical model of the tank with the specified dimensions or to a user-defined table. There are 3 types of curves and 8 types of tanks.

All types of transfer characteristics work with the value of the input magnitude as a percentage according to the settings of the input channel of the unit (see section 9.1. Setting of the input channel at the unit). The resulting value given by the conversion rules according to user configuration is displayed on the display and stored with the configured period in the internal memory.



If the extended measuring range is configured, conversion takes place also for the negative percentage value entry and values greater than 100 %.

The first step is to configure the desired conversion type and then the parameters of the selected transfer characteristics that are involved in the following sections.

TYPES OF CONVERSION CHARACTERISTICS		
Transfer characteristics	Name in the menu	Parameter menu
Linear curve	LINEAR CURVE	CURVE PARAMETERS (ID 034)
Quadratic curve	QUADRATIC CURVE	
Square root curve	SQUARE ROOT CURVE	
Vertical rectangular tank with a hopper	VERT. RECT. TANK	TANK DIMENSIONS (ID0 35)
Vertical cylindrical tank with a tapered termination	VERT. CYL. TANK TAPERED	
Vertical cylindrical tank with spherical terminations	VERT. CYL. TANK SPHER.	
Vertical cylindrical tank with ellipsoidal terminations	VERT. CYL. TANK ELLIP.	
Horizontal cylindrical tank with flat terminations	HOR. CYL. TANK FLAT	
Horizontal cylindrical tank with ASME type terminations	HOR. CYL. TANK ASME	
Horizontal cylindrical tank with ellipsoidal terminations 2:1	HOR. CYL. TANK E2:1	
Horizontal cylindrical tank with half spheric type terminations	HOR. CYL. TANK K1/2	
User defined table	USER TABLE	USER TABLE (ID 036)

- **Menu: CONVERSION TYPE (ID 033)**
- **Default: Linear curve**
- **[↔] - Change of value**



9.3.1. Transfer by the transfer characteristics

If linear, square or square root characteristics is selected as the conversion type, the resulting value of the conversion is the given by two points. The zero value of input magnitude (I_n) corresponds to the value of the "User minimum" (U_{min}) and the value of 100% input value (I_n) corresponds to the value of the "User maximum" (U_{max}). The resulting user value "W" is throughout the extended user range given by the mathematical dependence given below at the graphical display depending on the input value.



The value of the parameter "User minimum" may be greater than the value of the parameter "User maximum". When you increase the input values then the displayed and logged value decreases.

User minimum (U_{min})

- Menu: MIN. INPUT VALUE (ID 037)

Default: 0

User maximum (U_{max})

- Menu: MAX. INPUT VALUE (ID 038)

Default: 100

- [\leftrightarrow] - movement between characters [\updownarrow] - The increase of value of the marked digits (at marked decimal comma, a shift by an order occurs)

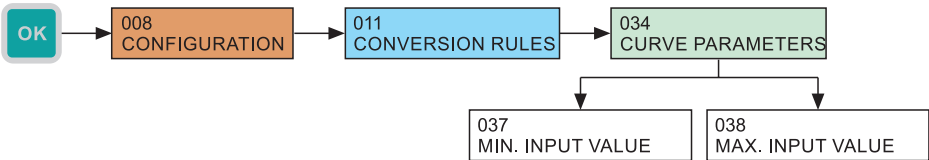

a). The linear characteristics

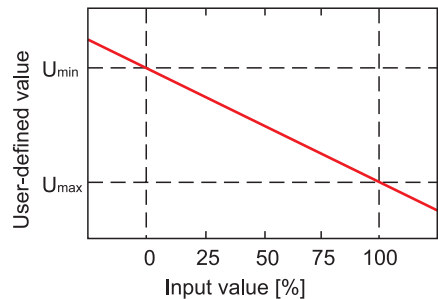
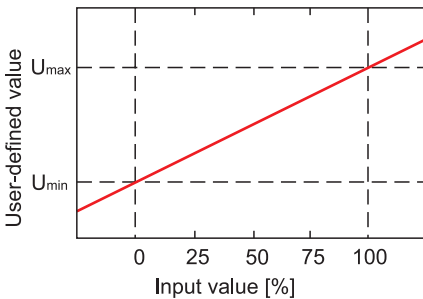

$$W = \frac{I_n[\%]}{100} \times (U_{max} - U_{min}) + U_{min}$$

b). The quadratic characteristics

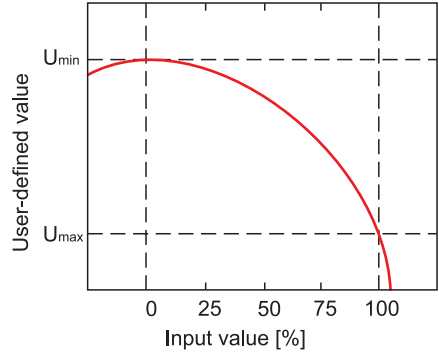
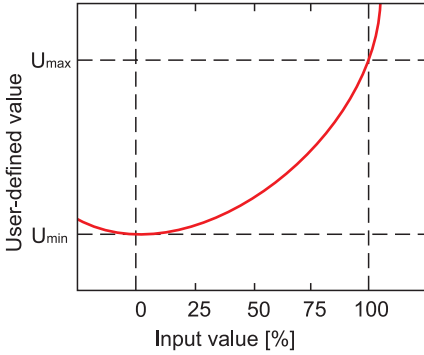

$$W = \left(\frac{I_n[\%]}{100} \right)^2 \times (U_{max} - U_{min}) + U_{min}$$

c). The square root characteristics

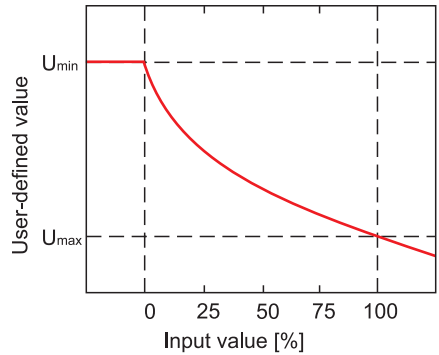
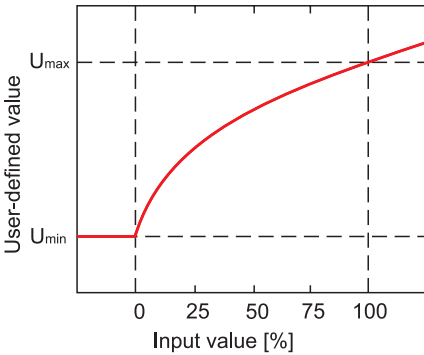

$$W = \sqrt{\frac{I_n[\%]}{100}} \times (U_{max} - U_{min}) + U_{min}$$



The above formula is valid only for non negative value of the input magnitude. If the input value is less than 0, the resulting user value "W" corresponds to the value of the "User minimum".

9.3.2. The tank mathematical model

The unit calculates the volume of the media in the tank according to the selected type and specified dimensions depending on the input value representing the level. Zero level of input (I_n) in per cents match the zero level in the tank. The input value at the level of 100 % represents the full tank.

The relationship between the level height and the input value:

$$h = \frac{I_n[\%]}{100} \times \text{Tank height}$$

If an extended measuring range is specified, then a mathematical model of the tank for the values of input value <0% keeps the zero value of volume and for values >100 % then the total volume of the tank (the value does no more increase).



If invalid dimension values are entered for the mathematical model of the tank, the model output value is zero regardless of the input value.

For each type of fuel tank, it is necessary to specify its width and height. Furthermore, it is necessary to specify up to three specific dimensions of the given tank as parameters A, B and C. The drawings of individual types of tanks with the specific dimensions are shown at the end of this chapter.

- **Menu: TANK DIMENSIONS (ID 035)**
- **[↔] - Movement between the characters [↑] - Change of Value**

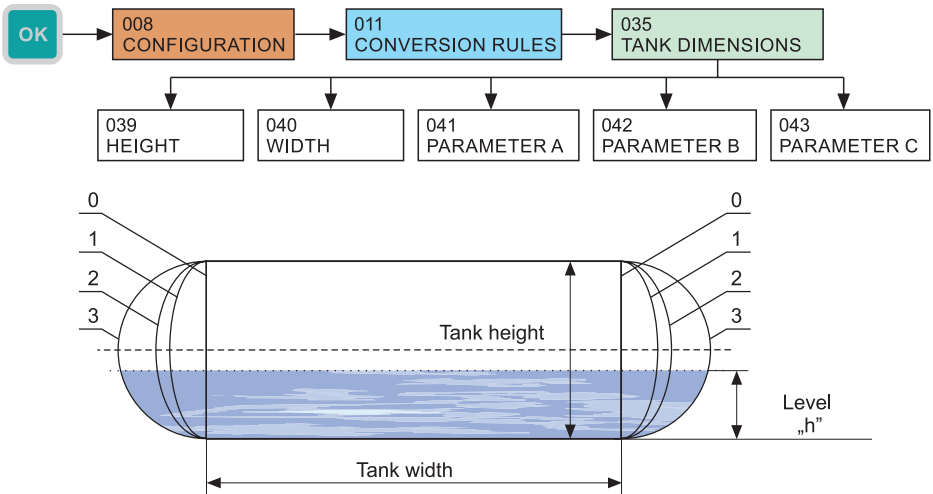

Fig. 1: Horizontal cylindrical tank - adjustable termination

- 0 ... Horizontal cylindrical tank with flat terminations
- 1 ... Horizontal cylindrical tank with ASME type terminations
- 2 ... Horizontal cylindrical tank with ellipsoidal terminations 2:1
- 3 ... Horizontal cylindrical tank with half spheric type terminations

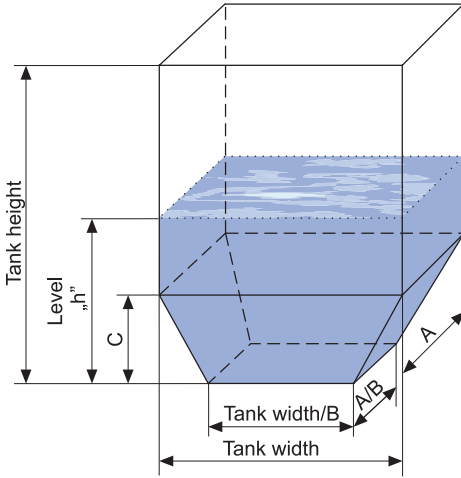

Fig. 2: Vertical rectangular tank with a hopper

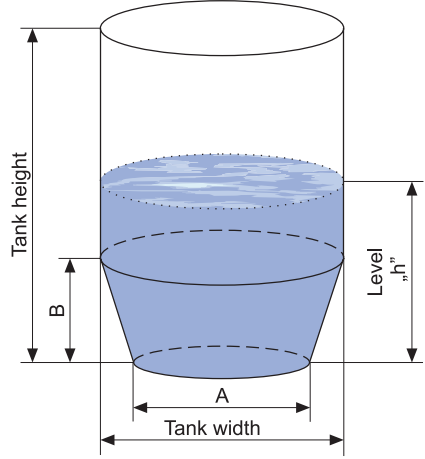

Fig. 3: Vertical cylindrical tank - tapered bottom termination

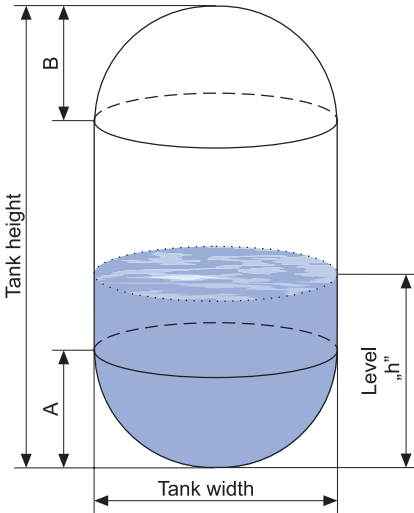

Fig. 4: Vertical cylindrical tank - spherical termination (ball)

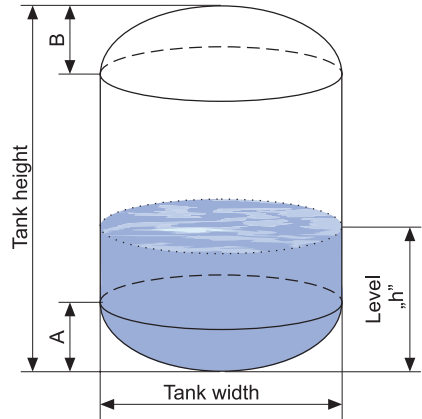
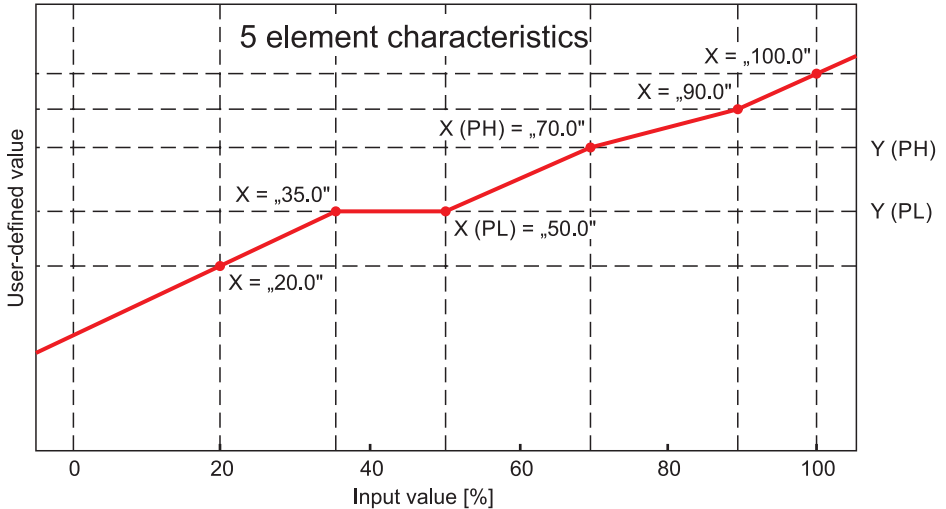

Fig. 5: Vertical cylindrical tank - ellipsoidal termination

9.3.3. User table

User defined characteristics is given as a set of points with coordinates X-Y, where the x coordinate is the value entry in percentages and the y coordinate of the required user value. The number of points is variable and can be configured from 2 to 32 points that make up linear segments. The conversion of the value of the input values less than x coordinate of the first point and greater than x coordinate of the last point is on the line of the two closest coincident points (see chart).



Considering any point of the curve “PL” (low) and the following point “PH” (high), while their x coordinates to describe as X (PL), X(PH) and y coordinates as Y(PL), Y(PH), then the user value “W” in the area between the two points is given by the relation:

$$W = \frac{I_n[\%] - X(PL)}{X(PH) - X(PL)} \times [Y(PH) - Y(PL)] + Y(PL)$$

a). Display of table points

The unit allows to view stored user points. The individual points are numbered from zero to 31. The x coordinate (input value in percent) and the y coordinate (user value) are always displayed.

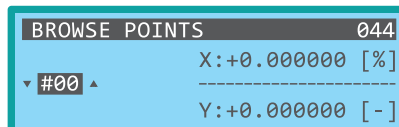

- **Menu: BROWSE POINTS (ID 044)**
- **[↑] - Display of the next point**



b). Adding a point to the user table

Specifying a point into the user table takes place in two steps. In the first step, the X coordinate of the point is specified whose value is continuously updated to the currently measured value of the input magnitude until its manual change or its confirmation. In the second step, the y coordinate of the point is specified.

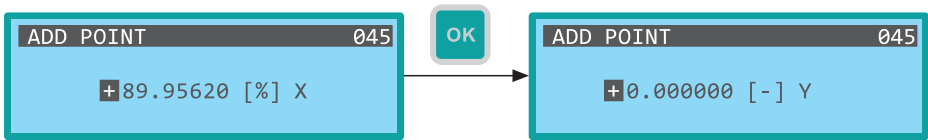

- **Menu: ADD POINT (ID 045)**
- [\leftrightarrow] - movement between characters [\updownarrow] - The increase of value of the marked digits (at marked decimal comma, a shift by an order occurs)



c). Deleting the last point of the table

The unit allows for deleting the last point added to the table. The unit requires a confirmation of this option by means of a dialogue

- **Menu: DELETE LAST POINT (ID 046)**
- [\leftrightarrow] - Change of selection YES/NO



d). Deleting the complete table

Another alternative is the deleting of the entire user table (all points). The unit requires confirmation of this option by means of a dialogue.

- **Menu: DELETE TABLE (ID 047)**
- [\leftrightarrow] - Change of selection YES / NO



9.4. OUTPUT RELAY

The unit processes the user value in accordance with the selected processing type. The user has the choice of five options listed in the table below. The evaluation works with the desired value specified by the user. The control process also requires specification of the hysteresis.

9.4.1. Selection of the processing type

- **Menu: PROCESSING TYPE ID (048)**
- **Default value: turned off**
- **[↔] - Change of value**



PROCESSING TYPES OF USER VALUES FROM THE POINT OF VIEW OF RELAY OUTPUT	
<i>Evaluation turned off</i>	TURNED OFF
<i>Alarm - signalling of exceeding the desired value</i>	ALARM - OVER
<i>Alarm - signalling of fall under the desired value</i>	ALARM - UNDER
<i>Two-state control by the desired value and hysteresis</i>	2-POS REGULATION
<i>Two-state control by the desired value and hysteresis and inverse output</i>	2-POS REGULATION INV.

The behaviour of the relay output depending on the user value and on the selected processing type is shown on the following graph. If the evaluation is turned off, the output relay is permanently open.

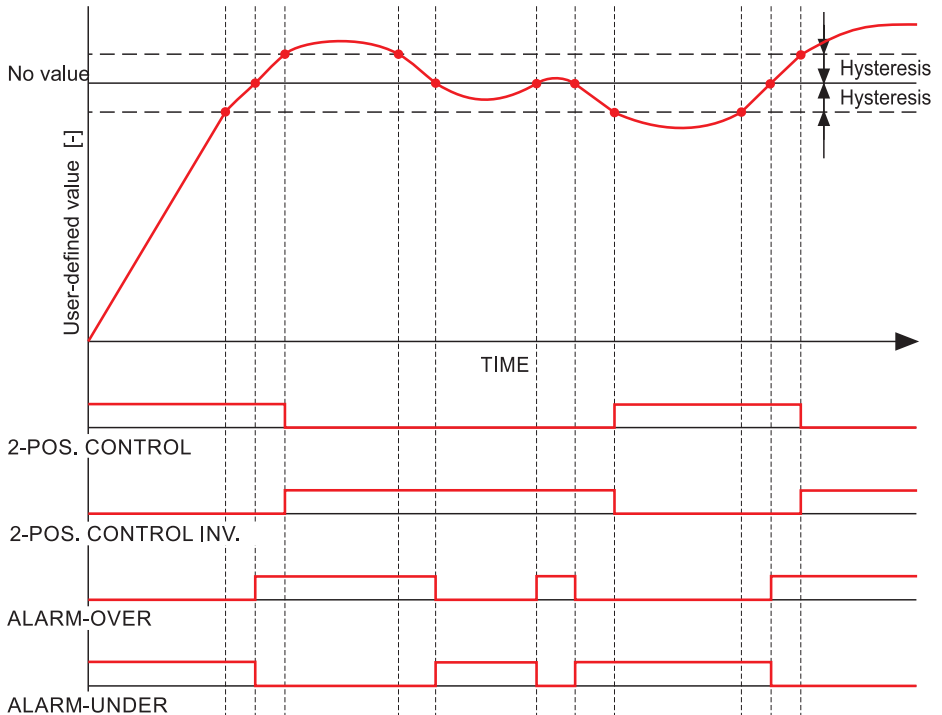

9.4.2. Configuration of the desired value

- **Menu: SETPOINT (ID 049)**
- [\leftrightarrow] - movement between characters [\updownarrow] - The increase of value of the marked digits (at marked decimal comma, a shift by an order occurs)

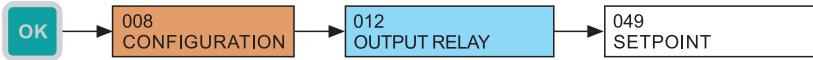

9.4.3. Hysteresis configuration

- **Menu: HYSTERESIS (ID 050)**
- [\leftrightarrow] - movement between characters [\updownarrow] - The increase of value of the marked digits (at marked decimal comma, a shift by an order occurs)

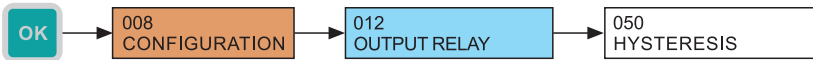

9.5. THE ARCHIVING AND DATA EXPORT CONFIGURATION

9.5.1. Archiving period

The unit stores the data on an internal FLASH memory with a period that the user can configure. The configuration can be in the range 1 second to 8 hours. The value is always entered in seconds. The beginning of this period is always the start of the unit, when the first value is stored after the start.

- **Menu: ARCHIV. PERIOD (ID 013)**
- **Default value: 2**
- [\leftrightarrow] - Movement between the characters [\updownarrow] - Increase of the marked digit value



9.5.2. The automatic data export to the SD card

The unit in default configuration exports internal memory to a file on an SD card immediately after its inserting into the unit's slot. This function can be disabled in the unit's menu. If the automatic export is prohibited, it can be called up in the unit's menu (see chapter 10.3. Data Export).

- **Menu: WHEN INSERTED ID (051)**
- **The check mark - change using [\leftrightarrow] directly in the menu.**

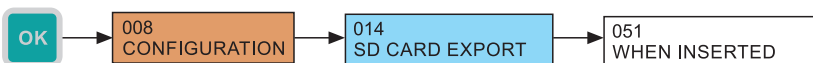

9.5.3. Backup mode configuration

The unit is equipped with an automatic backup function to the internal memory. At the selected events or at the specified time, the data export takes place from the internal memory to an SD card. In the default configuration, the backups are set to automatic mode when the export is made at complete filling of the internal memory, i.e. at the time, when the oldest values will be overwritten by the new ones. This function is only available if there is an SD card inserted in your device. Capabilities of automatic backup are given in the following table.

MODES OF THE AUTOMATIC BACKUP OF THE INTERNAL FLASH MEMORY	
Automatic backup turned off	DISABLED
Export at filling up the internal FLASH memory	AUTO (FULL FLASH)
Periodic daily export (at midnight)	DAILY (MIDNIGHT)
Periodic weekly export of data (at midnight from Sunday to Monday)	WEEKLY (MIDNIGHT)

- **Menu: BACKUP MODE (ID 052)**
- **Default value: AUTO (FULL FLASH)**
- **[↔] - Change of value**

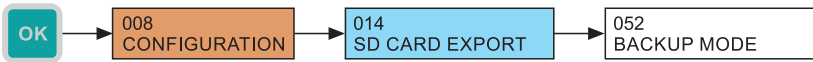

9.6. PARAMETRIZATION OF CONNECTED MEASURING DEVICES USING THE HART® PROTOCOL

The unit in PCU-100-H version makes it possible to communicate with measuring devices / level meters using the HART® protocol. HART® (Highway Addressable Remote Transducer) is a communication protocol used for setting up, reading measured data, and measuring device diagnostics. Communication proceeds via a 4–20 mA current loop and no additional wires are required. The unit allows communication via the HART® protocol with ULM-54, ULM-70, GRML-70, and CLM-70 level meters from Dinel s.r.o. It also allows you to communicate with third-party measuring devices that comply with the HART® Protocol Revision 5 to 7 as defined in the protocol standard.

The menu for communication with the measuring probe using the HART® protocol is accessible only after successful connection to this device.

If the display shows 'DEVICE SEARCH', periodic attempts are made to establish communication with the measuring device.

9.6.1. Basic parametrization of measuring devices using the HART® protocol

The PCU-100 unit with the HART® input (PCU-100-_-H-_-_) allows parametrization of basic parameters of the measuring device according to the HART® standard specification. These parameters are common to all measuring devices that support the HART® protocol. Therefore, they can also be set up for third-party devices if they comply with the relevant HART® standard specification.

The polling address setting in the measuring device

In this menu, the so-called polling address setting is carried out on the device in the range from 0 to 15. This address identifies the connected device. In order to continue communication between the device and the PCU-100, it is necessary to set the same polling address in the PCU-100 when such a change is made (see chapter 9.1.5).

- Menu: **POLLING ADDRESS (ID 063)**
- [↑] - Selection of the polling address 0 to 15

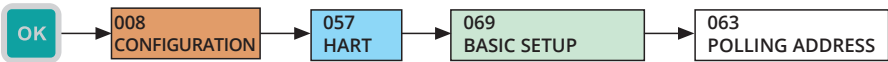

Setting of a lower range value in the measuring device

The lower range value is the minimum value that the measured magnitude can acquire.

- Menu: **BEGINNING OF RANGE (ID 065)**
- [↔] - Movement between characters, [↑] - Increase in the value of the marked digit (at marked decimal point, a shift by one order occurs)

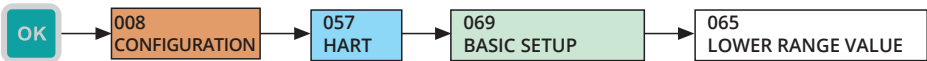

Setting of the upper range value in the measuring device

The upper range value is the maximum value that the measured magnitude can acquire.

- Menu: **END OF RANGE (ID 064)**
- [↔] - Movement between characters, [↑] - Increase in the value of the marked digit (at marked decimal point, a shift by one order occurs)

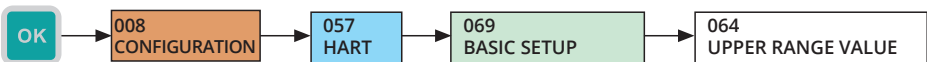

Averaging setting of the measured magnitude in the measuring device

Changing the averaging value makes it possible to suppress unwanted fluctuations at fast or jump changes in the measured quantity. It is entered as a number with a floating comma.

- **Menu: DAMPING (ID 066)**
- [**↔**] - Movement between characters, [**↑**] - Increase in the value of the marked digit (at marked decimal point, a shift by one order occurs)

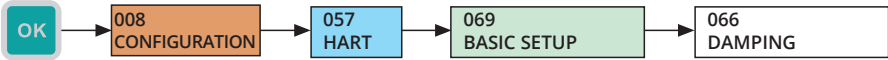

Restarting of measuring device

Restarts the measuring device.

- **Menu: RESET (ID 067)**
- [**↔**] - Change of the YES / NO option

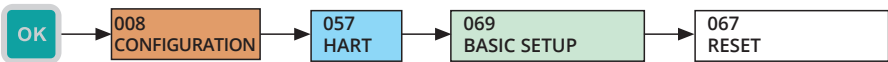

9.6.2. Parametrization of Dinel level meters with the HART® protocol support

This part of the menu is intended only for setting the ULM-54, ULM-70, GRLM-70, and CLM-70 level meters from Dinel, s.r.o. It is not displayed when a different device is connected. The basic settings for these probes can also be carried out in the BASIC PARAMETRIZATION (see chap. 9.6.1.). In the mentioned menu, however, it is possible to set, in addition to the basic parameters, also some other parameters that are specific for the mentioned devices. The individual items in this menu correspond to same items in the ULM-54, ULM-70, GRLM-70, and CLM-70 level meters menu. The PCU-100 automatically detects these types of level meters.



More detailed information on this setting is always available in the user manual for the relevant level meter.

Lower range setting of the measured magnitude in the level meter

The value of the measured magnitude at which the level meter output will be at the minimum (4 mA) is entered here.

For level meters using the reflex method (ULM-54, ULM-70, and GRLM-70), the value is entered in millimetres and it represents a distance of the level from the transducer face or from the beginning of the electrode. For level meters using the capacitance method for measurement (CLM-70) the measured capacity is entered directly in picofarads. The value is always a floating comma number.

- Menu: **MIN LEVEL (ID 072)**
- [↔] - Movement between characters, [↑] - Increase in the value of the marked digit (at marked decimal point, a shift by one order occurs)

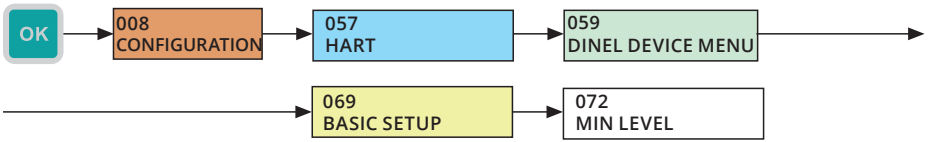

Upper range setting of the measured magnitude in the level meter

The value of the measured magnitude at which the level meter output will be at the maximum (20 mA) is entered here.

For level meters using the reflex method (ULM-54, ULM-70, and GRLM-70), the value is entered in millimetres and it represents a distance of the level from the transducer face or from the beginning of the electrode. For level meters using the capacitance method for measurement (CLM-70) the measured capacity is entered directly in picofarads. The value is always a floating comma number.

- Menu: **MAX LEVEL (ID 073)**
- [↔] - Movement between characters, [↑] - Increase in the value of the marked digit (at marked decimal point, a shift by one order occurs)

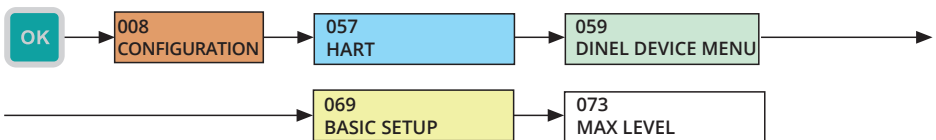

Physical units setting of the measured magnitude in the level meter

One of the following units can be set for the ultrasonic and radar level meters (ULM-70, ULM-54, GRLM-70):

- mm – distance in millimetres
- cm – distance in centimetres
- m – distance in meters
- in – distance in inches
- ft – distance in feet
- pf - distance in picofarad

Capacitive level sensors (CLM-70) supports following units only:

- pf - capacitive in picofarads

- Menu: **UNITS (ID 074)**
- [↑] - Changing the unit

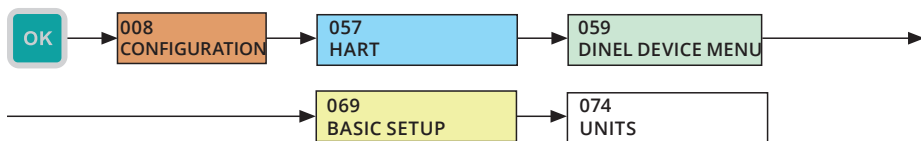

Averaging setting of the measured magnitude in the level meter

Setting of measurement response rate. It is useful to use the function for the suppression of fluctuations on the display at fast and jump changes in the level (whirling level). The subsequent reaction time will depend on the exponential curve. Damping with defined delay in seconds indicates the time that the exponential curve reaches 2/3 of its maximum value. The value is always a floating comma number.

- Menu: **DAMPING (ID 075)**
- [↔] - Movement between characters, [↑] - Increase in the value of the marked digit (at marked decimal point, a shift by one order occurs)

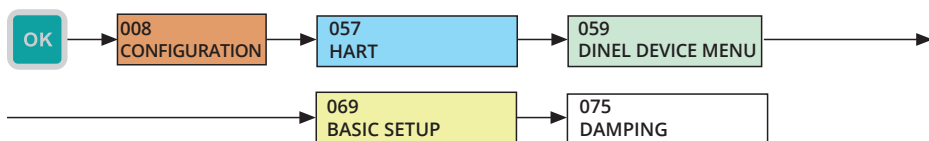

Reset of the level meter

This function restarts the measuring device. The option must be confirmed with "YES".

- Menu: **RESET (ID 083)**
- [↔] - Change of the YES / NO option

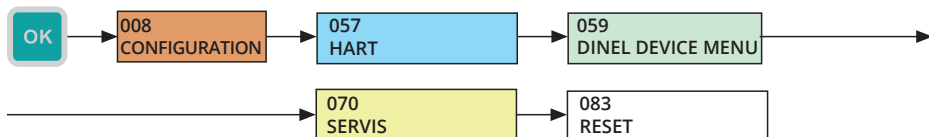

Sending a message to the level meter

Sending a message to the measuring device. The type and contents of supported messages depend on the connected device.

- Menu: **MESSAGE (ID 068)**
- [**↔**] - Movement between characters, [**↑↓**] - Character change

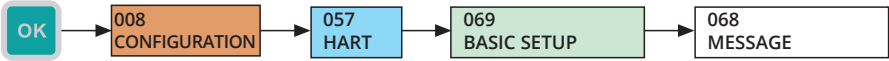

Sensitivity setting of the level meter

Preset sensor sensitivity levels are LOW (1), MEDIUM (3), and HIGH (5). To change the sensor sensitivity, select the appropriate item and confirm it.

i *The sensor sensitivity settings affect measurement properties and other parameters (such as dead zone size). Always read the instruction manual for the level meter before changing the setting.*

- Menu: **SENSITIVITY (ID 076)**
- [**↑↓**] - Sensitivity change

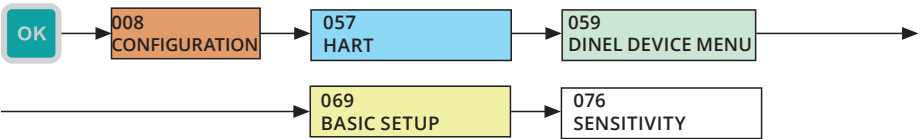

Sensitivity setting of the level meter defined by user

It is possible to set full sensitivity by entering a numerical value from one to eight. Preset sensor sensitivity levels are LOW (1), MEDIUM (3), and HIGH (5). Setting parameters outside these values is recommended only for experienced users or after consultation with the manufacturer.

i *This menu is only accessible after connecting the GRLM-70 radar level meter.*

i *The sensor sensitivity settings affect measurement properties and other parameters (such as dead zone size). Always read the instruction manual for the level meter before changing the setting.*

- Menu: **USER SENSITIVITY (ID 077)**
- [**↑↓**] - Sensitivity change

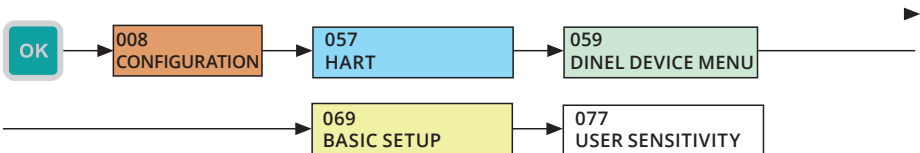

Start teaching in the level meter



This menu is only accessible after connecting the ULM-54, ULM-70 and GRLM-70 level meters.

A more detailed description is given in the instruction manual for each level meter. The indication of teaching that is running is shown in the DEVICE INFO menu in the STATUS line, where the TEACHING RUNNING text is displayed. After teaching is complete, the text changes to TEACHING ACTIVE.

- Menu: **TEACHING (ID 078)**
- [↔] - Change of the YES / NO option

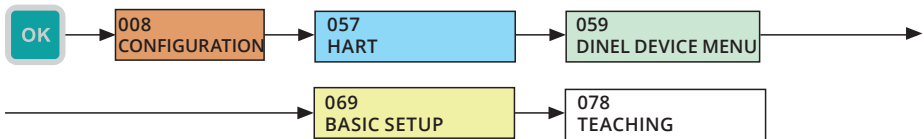

Setting of the medium temperature in the level meter



This menu is only accessible after connecting the ULM-54 or ULM-70 level meters.

In this part of the menu, the medium temperature is set. A more detailed description is given in the user manual for the level meter.

- Menu: **MEDIUM TEMPERATURE (ID 080)**
- [↔] - Movement between the characters; [↑] - Change of value

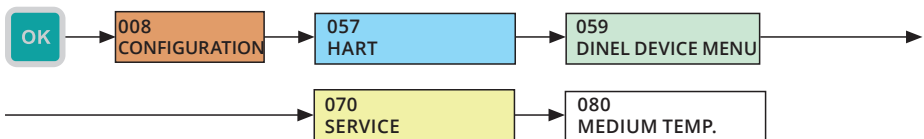

Setting of the electrode type in the level meter



This menu is only accessible after connecting the GRLM-70 radar level meter.

In the above-mentioned menu it is possible to set the measuring electrode type and its length in millimetres for the GRLM-70 level meters. GRLM-70 can be used with different electrode types. A more detailed description is given in the user manual for this level meter.

- Menu: **ELECTRODE (ID 079)**
- [↔] - Movement between characters indicating the type of electrode and its length. The type is represented by two digits following “E:” and the length by 5 digits following “L:” and is entered in millimetres; [↑] - Change of value

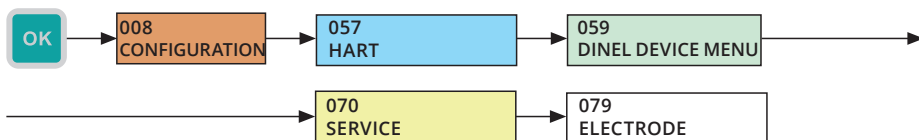

Factory default of the level meter

It allows you to delete all user-set changes and return the level meter to the factory default settings.

- Menu: **FACTORY DEFAULT (ID 082)**
- [↔] - Change of the YES / NO option

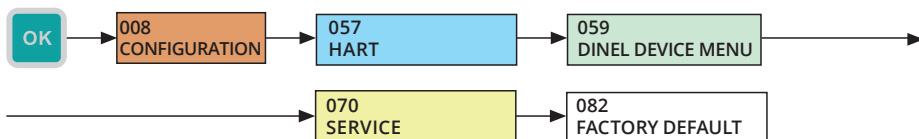

- **POLLING ADDRESS**
The numerical address of the device in the range of 0–15, serving for identification and recognition of individual level meters connected to the PCU.
- **TAG**
Device text identifier.
- **DESCRIPTION**
Additional text description of the connected device.
- **STATUS**
Information on the actual status of the connected device. It is displayed only in Dinel s.r.o. products. (ULM-54, ULM-70, GRLM-70, and CLM-70). It can acquire the following values:
 1. **ECHO OK:** The echo (reflection) was captured in the last measurement.
 2. **LEVEL_ABOVE_RANGE:** The measured level is above the measuring range or within the dead zone.
 3. **LEVEL_BELOW_RANGE:** The measured level is below the measuring range.
 4. **TEACHING_RUNNING:** TEACHING is running (an empty tank curve is created) or electrode is changed.
 5. **TEACHING_ACTIVE:** TEACHING: is active (a newly created empty tank curve is used).
 6. **LOW_VOLTAGE:** Low supply voltage.

- **CURRENT**
Current in loop in mA.
- **PV**
Primary measured value. For the ULM-54, ULM-70, and GRLM-70 level meters it is a distance to the level, for CLM-70 it is a capacity.
- **SV**
Secondary value. This value is shown on the display of the level meter.
- **TV**
Tertiary value. For the ULM-54 and ULM-70 probes it is the temperature in °C. Not used for the GRLM-70 and CLM-70 probes.
- **QV**
Quaternary value. For the GRLM-70, ULM-54 and ULM-70 level meters, it is a height of level. For the CLM-70 level meters, this value and the primary value are identical.
- **UPPER LIMIT**
The highest possible primary value that the level meters can measure.
- **LOWER LIMIT**
The lowest possible primary value that the level meters can measure.
- **END OF RANGE**
The actual maximum possible value of the primary quantity measured. It can be changed in the menu [link to menu 9.6.2] in the range given by the LOWER LIMIT and UPPER LIMIT values.
- **START OF RANGE**
The actual minimum possible value of the primary quantity measured. It can be changed in the menu [link to menu 9.6.2] in the range given by the LOWER LIMIT and UPPER LIMIT values.
- **DAMPING**
An averaging value that allows you to suppress unwanted fluctuations at fast and jump changes in the measured quantity. It can be changed in menu [link to menu 9.6.4]
- **SERIAL NUMBER**
Device serial number.

Info about device

From the connected measuring device it is possible to display information about the level meter type, measured quantities, serial number, etc.

- **Menu: (ID 060)**
- **[↑] - Changing of the display of individual info about device.**

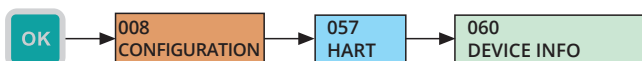

9.7. OTHER SETTINGS OF THE CONTROL UNIT

9.7.1. Date-time change

Actual date and time settings for the inner real time circuit can be made on one of the screens shown below. Active digit is represented by two arrows.



If a loss of actual information about the date and time takes place, check the internal battery (see Chapter 14. Use, manipulation and maintenance)



If the date is modified later, it is recommended clearing the internal Flash memory in the unit. Searching for values when browsing the saved data in the unit's menu may not work properly in this case.

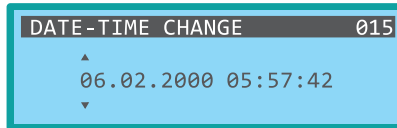

- Menu: DATE-TIME CHANGE (ID 015)
- [↔] - Movement between the characters, [↑] - Increase in the marked digit value

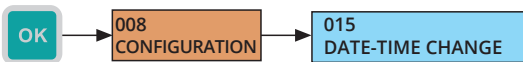

9.7.2. Password change

To change the password for the unit configuration, the actual valid password must be re-entered and then the new password. The password may have up to 9 digits.

The default password for entry into the configuration part	000012345
--	-----------



It is strongly recommended that you change the default password in the operated units.

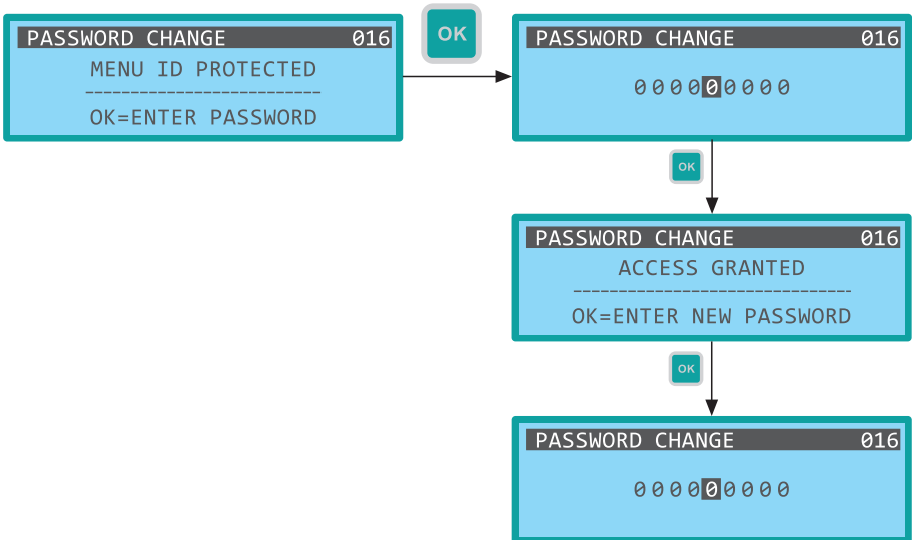

- Menu: **PASSWORD CHANGE (ID 016)**
- [↔] - Movement between the characters, [↑] - Increase in the marked digit value

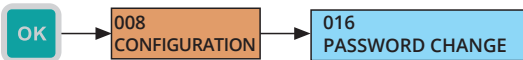

9.7.3. Default settings

Restoring the unit into the factory default settings is possible through the below shown menu item after agreement to the confirmation dialogue.

 The action will not affect the data saved in the internal FLASH memory.

 This action is irreversible.

- Menu: **FACTORY DEFAULT SETTINGS (ID 017)**
- [↔] - Change of the YES / NO option

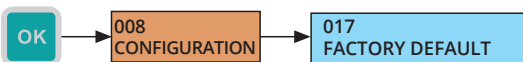

9.7.4. Delete internal FLASH memory

The user can delete the internal FLASH memory in the unit. This action is particularly suitable for the reduction of the data file exported to the SD card if the data was already archived or is no longer needed. For the memory clearing, approval of the confirmation dialogue is necessary.



This action is irreversible.

- Menu: **ERASE FLASH MEM. (ID 053)**
- [↔] - Change of the YES / NO option

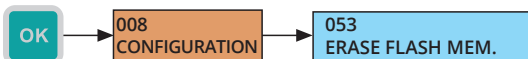

9.7.5. Restart of the control unit

To restart the device, the user can use the below shown item in the menu. Restart is performed after approval of the confirmation dialogue.



The action will affect neither the unit's settings nor the data saved in the internal FLASH memory.

- Menu: **RESTART DEVICE (ID 018)**
- [↔] - Change of the YES / NO option

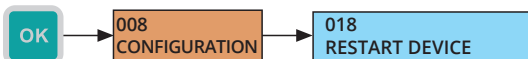

9.7.6. Lock the control unit

For the immediate abolition of the access to the adjustment part of the menu, the user can use the following item in the menu. After selecting the item, exiting of the menu takes place and, at the next entry into the menu, the password will be again required for the adjustment part.

- Menu: **EXIT SETUP (ID 019)**

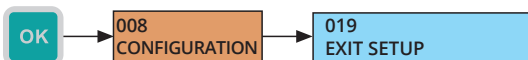

9.8. MENU STRUCTURE

Entering the menu:

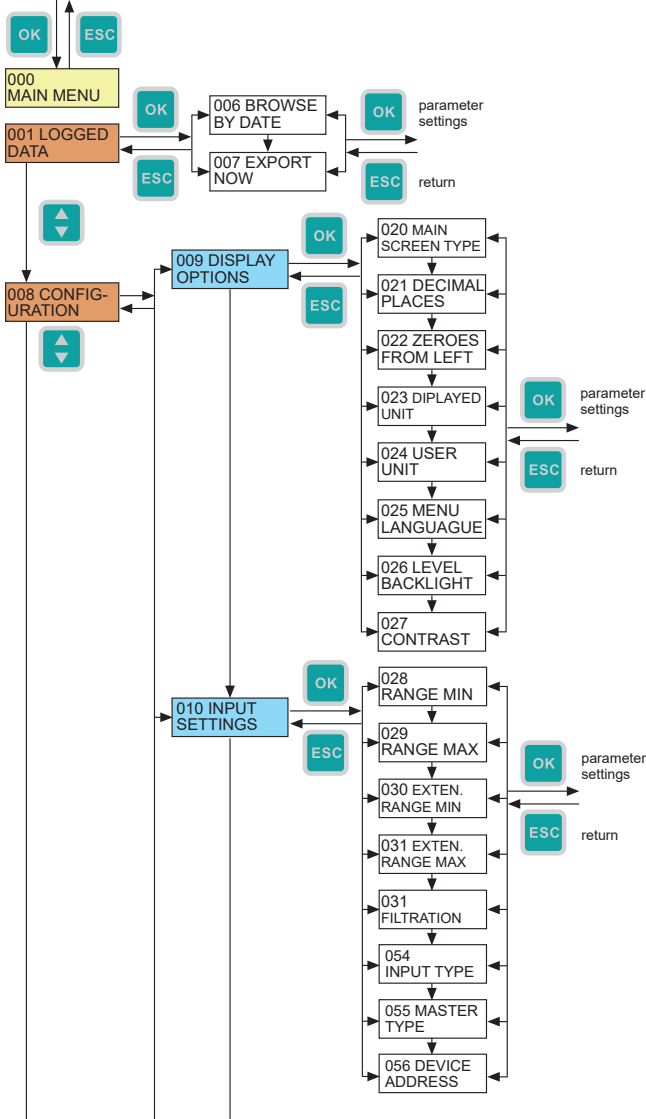

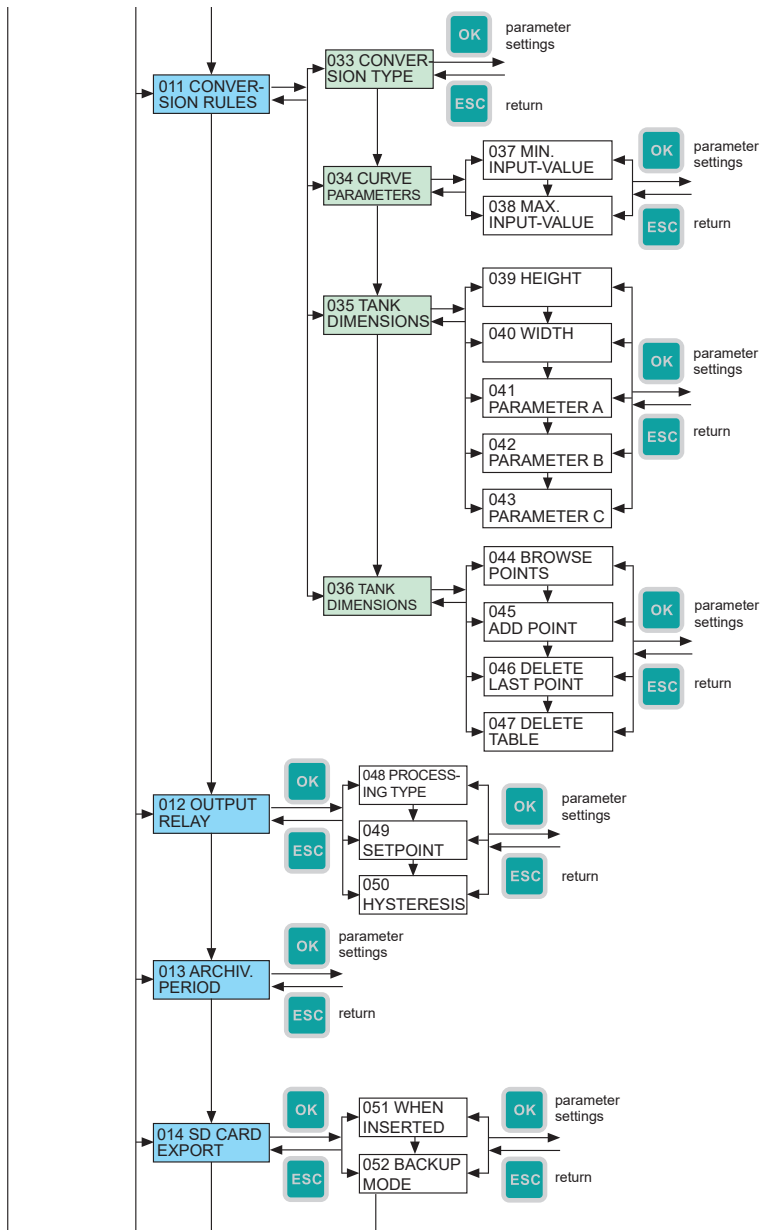

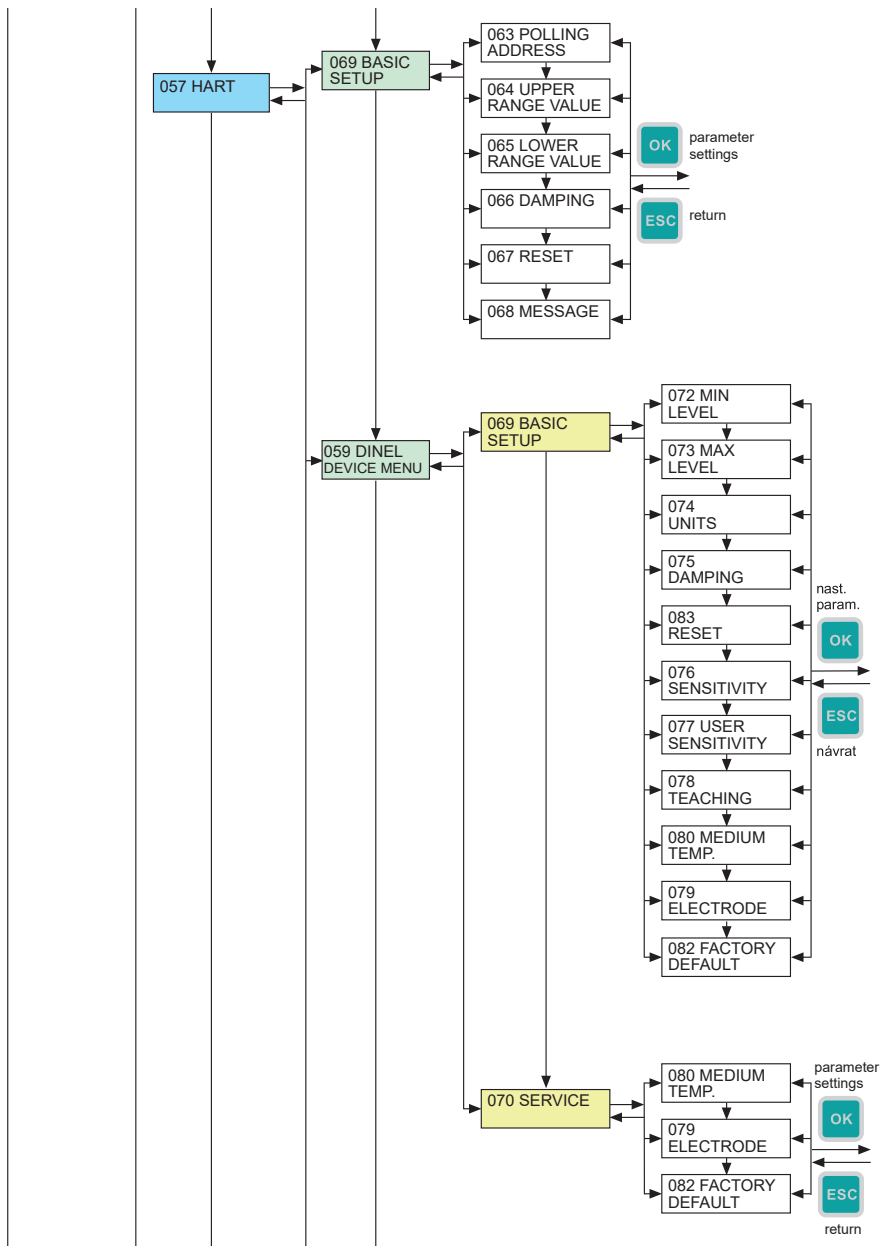

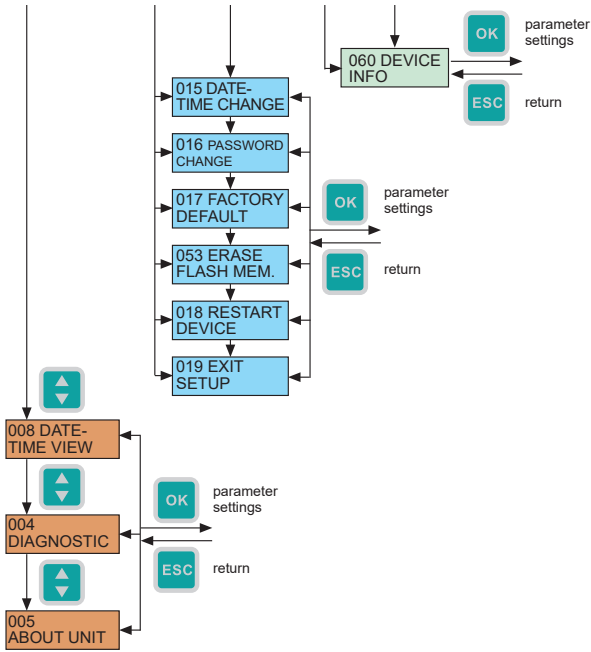

10. FUNCTIONS OF THE DEVICE

10.1. DESCRIPTION OF THE FRONT PANEL

PCU-100-D

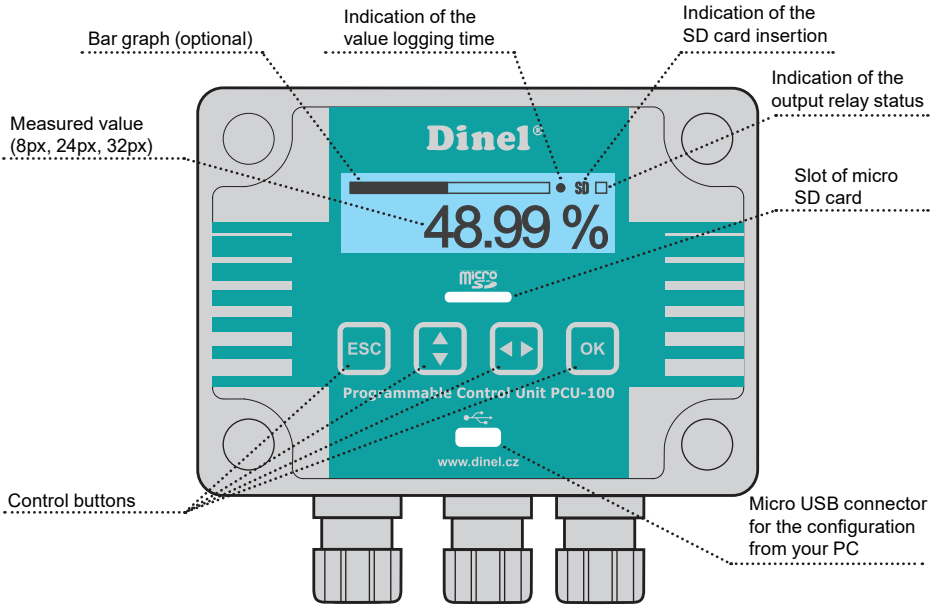

PCU-100-L

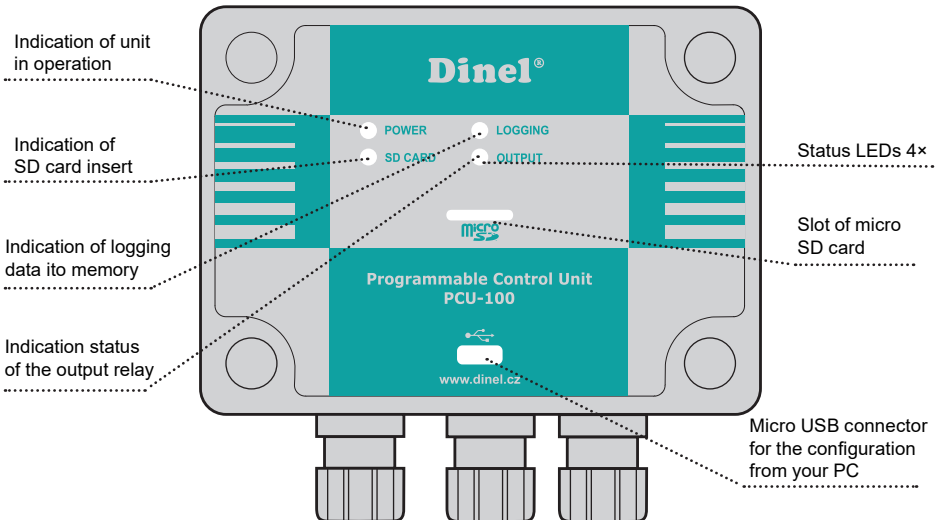

10.2. SIGNALLING FUNCTIONS

PCU-100-L

LED POWER:

- Flashing: Unit in operation
- Lit: Initialization

LED LOGGING:

- Indication of the instant of logging data into memory (blinking for 500ms)

LED SD CARD:

- Flashing: Data entry to the SD card
- Lit: SD card inserted
- Information on the threshold configuration of individual relays

LED OUTPUT:

- Status of the output relay

PCU-100-D - Error Values (instead of the measured value)

- + N/A Input value is below the minimum level of the extended range.
- - N/A Input value is above maximum of the extended range.
- N/A Entry error or inadmissible conversion parameters
- +Over Value to display greater than 999999
- -Over The Value to display less than -99999.9

10.3. EXPORT OF DATA

- The logged data from the internal memory of the unit can be exported to a micro SD card for additional processing. For access to the slot for memory card insertion, it is necessary to withdraw first the transparent polycarbonate housing of the front panel that is held in place by 4 plastic screws (see chapter Mechanical Assembly).
- In the default configuration export of data to the SD card will take place immediately after inserting a memory card into your device. This behaviour is possible to modify in the configuration and run data export manually through the menu (see chapter 9.5.2 Automatic export of data on the SD card) or configuration application of the unit.
- The unit can also be configured for automatic export of the data to the SD card, whether periodically or when the internal memory is full (see chapter 9.5.3 Configuration of the backup mode). For the functioning of these automatic backups, it is necessary to keep the memory card inserted in the unit. After the completion of the work with the data, it is necessary to return the transparent polycarbonate housing of the front panel back on its place and properly tighten the screws to achieve full coverage.



Be extremely careful when placing the cover in place. It is not possible to settle the front cover arbitrarily, there are located protrusions on the bottom of the housing and on the body of the boxes. At bad settlement, these protrusions may prevent the full engagement of the seal and the achievement of full coverage.

The data are stored on a memory card in CSV format. Path to the stored file will be as follows: /PCU-100/SNXXXXXX/DATA_YYY.CSV, where XXXXXX is the serial number of the unit and YYY sequence number of the file. Up to 999 files with exported data can be saved for each unit of the PCU-100 without overwriting the previous file.



The delimiter in a CSV file is dependent on the selected menu language. EN: “,” CZ: “;”

- **Menu: EXPORT NOW (ID 007)**



10.4. DISPLAYING FUNCTIONS OF THE USER MENU

The function of the user menu in the version with the display (PCU-100-D) are not restricted only to the configuration of the unit. Additional functions for data management and diagnostics are described in this chapter.

10.4.1. Browsing through the data saved in the FLASH memory

This unit enables displaying the values stored in the internal FLASH memory. First, date is specified by means of the interface, to which the user requires to view the values. The unit then searches for a saved location closest to this date and displays the value. Then, the user can move in memory from this position in the time forward or backward by pressing the appropriate button. The search for the requested date may be any time repeated.

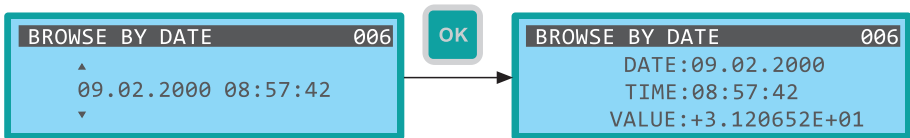

- **Menu: BROWSE BY DATE (ID 006)**

Time Specification

- [↔] - Movement between the characters [↑] - Increase of the marked digit value

Move to the requested position

- [↔] - A shift by a position back, [↑] - A shift by a position forward



10.4.2. Display of the real date and time of the unit

Even without entering the password for the unit configuration, it is possible to display the current real date and time of the unit on the screen. Its change is possible only in the configuration (see chapter 9.6.1).

- **Menu: DATE-TIME VIEW (ID 003)**



10.4.3. The diagnostic options

Particularly, when installing the unit into operation and its initial configuration, the information displayed on the physical value input values and the corresponding user value according to the current configuration can be useful at the same time. Therefore, the user has available the screen, where there is also displayed the input value in the appropriate units and its conversion into the percentage value and the resulting user value for viewing and archiving. All values are displayed in real time without filtration (dumping).



The value of the input magnitude in percentage is important for all user conversion types. The correct configuration of the input range is therefore crucial for the correct function of the conversion.

- **Menu: DIAGNOSTIC (ID 004)**



004
DIAGNOSTIC

For determination of the basic production data about the unit, the specified screen can be used. This screen shows the unit type, its serial number and the firmware version.

- **Menu: ABOUT UNIT (ID 005)**



005
ABOUT UNIT

10.5. UNIT FIRMWARE UPDATES



Firmware updates should always be consulted with the manufacturer. The firmware update application will be delivered individually including a new program.

The PCU-100 unit allows the user to upgrade the unit firmware using a PC application. The computer is connected to the unit using a micro USB cable. The USB cable must be connected to the unit before applying power to the unit to enter the firmware upgrade mode.



For units with a display, the firmware update mode will be visually indicated by the maximum brightness of display backlight, whereas nothing is displayed. For units without a display, all status LEDs are permanently lit.

11. ORDER CODE

PRODUCT	
PCU-100	
DISPLAY TYPE	
D	with LCD display
L	without LCD display
UNIT'S INPUT	
I	current input
H	current input (with HART® communication)
OPTIONAL EXPANDABLE MODULE	
0	without the expanding I/O module
SUPPLY VOLTAGE	
230 V	AC power supply 85 + 253V AC / 50 + 60Hz
PCU-100 - D - I - 0 - 230V	AVAILABLE PRODUCT ALTERNATIVES

12. CORRECT SPECIFICATION EXAMPLES

PCU-100-D-I-0-230V

(D) version with display; (I) current entry; (0) without the expanding I/O module; (230V) power supply voltage 230 V.

13. SAFETY, PROTECTIONS AND COMPATIBILITY

The PCU-100 unit is protected by an internal blow fuse. The current unit input is protected against short circuit.

The electrical device of the protection class II. Electrical safety according to EN 61010-1.

The electromagnetic compatibility is ensured by compliance with standards EN 55011, EN 61326-1, EN 61000-3-2, EN 61000-3-2, -3-3, -4-2 (4 kV/8 kV), -4-3 (10 V/m), -4-4 (1 kV /2 kV), -4-5 (2 kV), -4-6 (10 V) and -4-11.

14. USE, MANIPULATION AND MAINTENANCE

The operator can do the control of the unit function (displayed data) and of the device operator through the MENU that is not protected by password and, also, copy the archived data to the Micro SD card.

The device contains the user-replaceable battery for backup of the real time circuit in the bracket on the bottom side of the unit's front panel. For the access to it, it is necessary to remove the front panel (see section 8. Electrical connection). Then, we move the battery out of the bracket to the side and replace it with a new one. The battery must be replaced if the unit is not able to store the configured real time without a connected power supply.



Battery Type: coin cell CR2032, 3V, operating temperature range at least -25 to 70 °C.

The maintenance of the device consists of removing dust from the surface of the device and checking of the box integrity. In the case of detection of any visible defects, immediately inform the manufacturer or reseller of the device. The spaces, in which you can use the power unit are determined in the Article 2 of these technical specifications.



Any changes or interventions without the permission of the manufacturer are forbidden to be performed on the PCU-100. Any repairs must be carried out only at the manufacturer or by his authorized service organization.

The assembly, installation, commissioning, operation and maintenance of the PCU-100 must be carried out in accordance with this manual and must comply with the provisions of the standards in force for the installation of electrical device.

15. GENERAL, CONDITIONS AND WARRANTY

The manufacturer guarantees from the supply that this product will have established properties given in the technical conditions for a period of 3 years.

The manufacturer is responsible for the faults that have been identified during the warranty period and were claimed in writing.

The warranty does not apply to defects resulting from improper handling or failure to comply with the technical specifications.

The warranty shall expire if the customer or a third party carries out changes or modifications of the product, if the product is mechanically or chemically damaged, or if the production number is not legible.

For the application of a claim, it is necessary to submit the certificate of warranty.

In the event of justified complaint, we repair the defective product, or replace it with a new one. In both cases, the warranty period shall be extended by the time of the repair.

16. MARKING OF LABELS

Data on the plate of the unit of **PCU-100** series

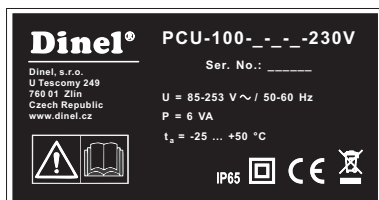

The manufacturer's mark: Dinel® logo

Contact: Dinel, s.r.o., U Tescomy 249, 760 01 Zlín, Czech Republic, www.dinel.cz

Unit type: PCU-100-_-_-_-230V

Serial number of the product: Ser. No.: _____ - (from the left: production year, serial production number)

Supply voltage: U = 85 - 253 V / 50 - 60 Hz

Rated power consumption: 6 VA

Operating temperature range: $t_a = -25$ to $+50$ °C

Degree of protection: IP65

The character of double insulation (device of protection class II):

The conformity mark: **CE**

The symbol for the return of WEEE -:



Plate size 50 × 26 mm, the size displayed does not correspond to reality.

17. TECHNICAL SPECIFICATIONS

BASIC TECHNICAL DATA	
Supply voltage	85 - 253 V AC
Rated power consumption	6 VA
Outlet	1 × SSR relay, max. 250 V AC / 100 mA
Inlet	active current loop (4 - 20 mA) power supply 24 V +/- 10%, serial impedance <110 Ω
Measuring accuracy	+/- 0,1 %
Display type	graphical LCD 132 × 32 px with backlight
Control	Foil keypad - 4 buttons, PC program - connect the micro USB
Internal memory size	min. 500,000 records
Archiving Period	user adjustable (1 sec to 8 hours)
The menu language	Czech, English
Dimensions	110 × 80 × 65 mm
Weight	320 g
Housing - material	ABS/PC
Protection class	IP 65
Ambient working temperature	-25°C to +50°C

ELECTRICAL PARAMETERS OF THE RELAY OUTPUT	
Maximum switched voltage	±50 V DC / 230 V AC
Max. switched current	±120 mA DC / 80 mA AC
Maximum resistance is in the closed state	30 Ω
The maximum current flowing through the opened contacts	1 μA (U = 100 V)
Insulating Voltage	5 kV AC (RMS)

18. PACKING, SHIPPING AND STORAGE

The PCU-100 is wrapped in a polyethylene bag and the whole consignment is placed in a card box. In the carton box, appropriate padding is used to prevent mechanical damage during transport.

Remove the device from the packaging just before its use, you may avoid possible damage.

The transport to the customer is realized by means of a forwarding company. After a prior agreement, personal taking of the ordered goods from headquarters is also possible. When taking over, please make sure that the consignment is complete and corresponds to the extent of the order, and that no damage occurred to the device when transporting. Do not use a device obviously damaged during transport, but contact the manufacturer in order to address the situation.

If the device is to be transported further, then only wrapped in the original packaging and protected against shocks and weather conditions.

Store the device in the original packaging in dry areas covered from the weather conditions, with a moisture up to 85 % without any effects of Chemically active substances. Storage temperature range is -10 °C to +50 °C.

Dinel[®]

industrial electronics

Dinel, s.r.o.
U Tescomy 249
760 01 Zlín
Czech Republic

phone: +420 577 002 002
email: obchod@dinel.cz

www.dinel.cz

The current version of the manual can be found on www.dinel.cz

Version:



QMS
ISO 9001

