



HIGH-FREQUENCY LIMIT LEVEL SENSOR RFLS-35



CONTENTS

1. Basic description.....	4
2. Variants of sensors	5
3. Dimensional drawing	5
4. Installation and putting into operation	7
5. Installation instructions	8
6. Electrical connection.....	10
7. Control elements.....	11
8. Settings.....	12
9. Function and status indication	15
10. Order code.....	16
11. Correct specification examples.....	16
12. Accessories	16
13. Safety, protections, compatibility and explosion proof	17
14. Use, manipulation and maintenance	17
15. General, conditions and warranty.....	18
16. Marking of labels.....	18
17. Technical specifications.....	20
18. Packings, shipping and storage.....	22

USED SYMBOLS

To ensure maximum safety of control processes, we have defined the following safety instructions and information. Each instruction is labelled with the appropriate pictogram.



Alert, warning, danger

This symbol informs you about particularly important instructions for installation and operation of equipment or dangerous situations that may occur during the installation and operation. Not observing these instructions may cause disturbance, damage or destruction of equipment or may cause injury.



Information

This symbol indicates particularly important characteristics of the device.



Note

This symbol indicates helpful additional information.

SAFETY



All operations described in this instruction manual have to be carried out by trained personnel or by an accredited person only. Warranty and post warranty service must be exclusively carried out by the manufacturer.

Improper use, installation or set-up of the sensor can lead to crashes in the application.

The manufacturer is not responsible for improper use, loss of work caused by either direct or indirect damage, and for expenses incurred at the time of installation or during the period of use of the level sensors.

1. BASIC DESCRIPTION

The **high-frequency level sensor RFLS-35** is designed for industrial use for limit sensing of the level of liquid and paste-like media. The high-frequency level sensor may be a direct replacement of a vibrating level sensor, or of a capacity level sensor in case of more demanding applications. The media may be electrically conductive or non-conductive with any permittivity. It can be installed in metal or plastic tanks, pipes, filling tanks, sumps, etc.

It is mainly designed for mounting into the wall of a tank or pipe, in which the actual detection of the level will take place. The sensor works in the high frequency band, enabling reliable detection of the level of media, and eliminating deposits or foam on the electrode. The sensor suppresses the influence of deposits of viscous media (ketchup, yoghurt, pastes, syrups, jams and jellies, creams, soap) as well as electrically conductive adhesive products (detergents, alkalis, chemicals).

Likewise, it is possible to utilize it to differentiate a specific media from others - the "Medium window" function. E.g. it can differentiate oil from water and air, detect only beer foam and ignore beer and air, etc.

The sensor is made from a stainless steel housing at one end terminated by a sensing electrode, and terminated at the other and by an ending with a status indicator, control elements and electrical connection.

There are next performances available: **N** – For normal atmospheres, **Xi** – Explosion proof – intrinsically safe for hazardous (explosive) areas. and **XiM** – Explosion proof – intrinsically safe for use in mines with methane or flammable dust presence danger (see technical specifications).

2. VARIANTS OF SENSORS

- **RFLS-35_-1B** **Insulated electrode (PEEK) with sealing O-ring NBR**, for sensing various liquid, mashed and paste-like materials, appropriate also for fuel, oil or methanol, use from minimum temperature of -40 °C
- **RFLS-35_-1E** **Insulated electrode (PEEK) with sealing O-ring EPDM**, for sensing various liquid, mashed and paste-like materials, appropriate also for acids, bases or alcohol, ammonia, acetone, chlorine, from minimum temperature of -40 °C
- **RFLS-35_-1V** **Insulated electrode (PEEK) with sealing O-ring Viton**, for sensing various liquid, mashed and paste-like materials, appropriate also for fuel, oil, acids, bases or asphalt, tar, toluene, use from minimum temperature of -20 °C
- **RFLS-35_-2** **Insulated electrode (PTFE) without O-ring**, for sensing various liquid, mashed and paste-like materials, especially suitable for aggressive liquids, use from minimum temperature of -40 °C.

3. DIMENSIONAL DRAWING

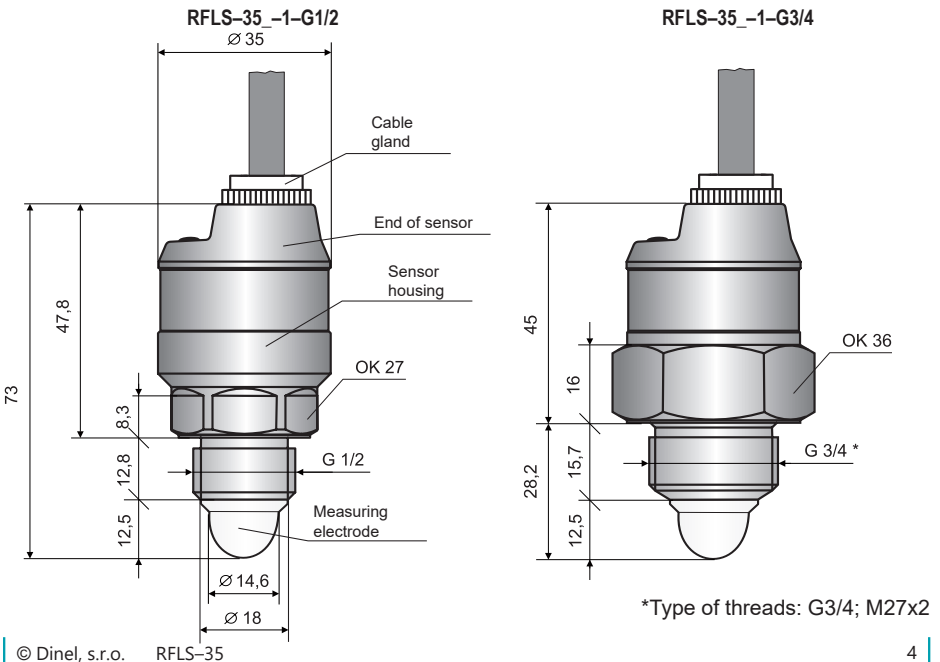

RFLS-35_-2-G1/2

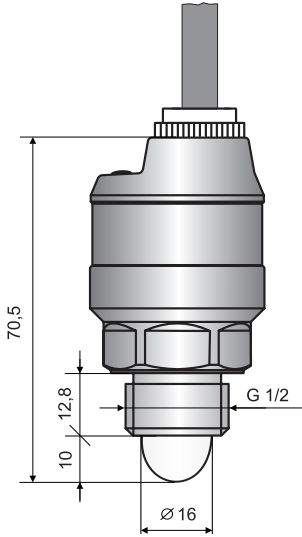

RFLS-35_-2-G3/4

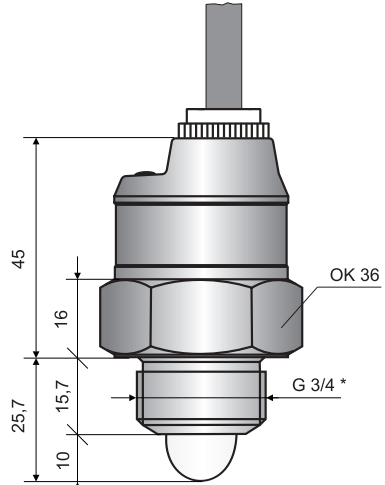

*Type of threads: G3/4; M27x2

RFLS-35_-2-CI50
(Tri-clamp)

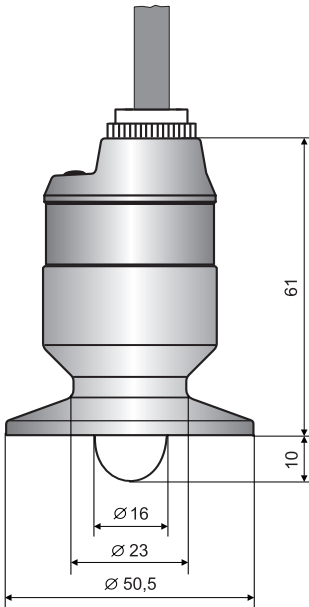

RFLS-35_-2-CI34
(Tri-clamp)

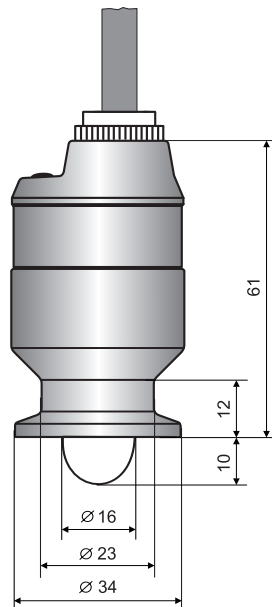

Variant "A" with short stainless steel gland

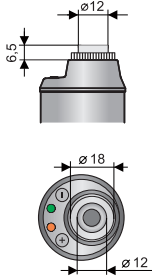

Variant "B" with plastic threaded cable gland

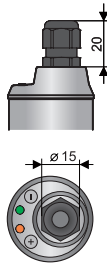

Variant "C" with connector M12

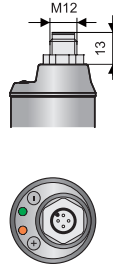

Variant "D" with dustproof cable outlet

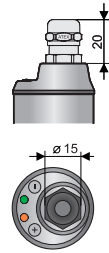

Variant "V" with plastic cable gland with spiral relief – in case of increased mechanical wear on the cable.

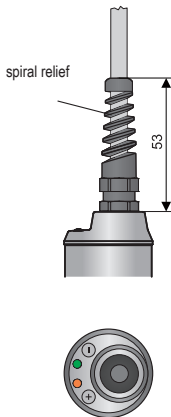

Variant "H" with cable gland for protected hoses – for using in an outdoor area or in area with increased moisture.

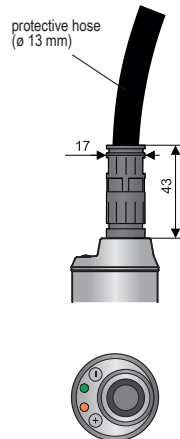

4. INSTALLATION AND PUTTING INTO OPERATION

Please follow next 3 steps:

- **INSTALLATION INSTRUCTIONS**
- **ELECTRICAL CONNECTION**
- **SETTINGS**

5. INSTALLATION INSTRUCTIONS

RFLS level sensors can be mounted in horizontal or inclined position into the shell of a container, storage tank or pipe by screwing into the welding flange, or by affixing using a nut. Basic application recommendations are mentioned below.



During assembly into the metal tank or the storage tank, it is not necessary to separately ground the base of the level sensor



In the case of the use for an aggressive medium is necessary to prove the chemical compatibility of used materials of the sensor (Tab. Used materials on page 19). This guarantee ceases when the product is chemically damaged.

Thanks to its design, the sensor is appropriate for detection of the level of **viscous and simultaneously electrically conductive media** (yoghurt, jams and jellies, mayonnaise, spreads, liquid soap, creams or pastes). After setting the sensitivity of the given media, it reliably reacts to the presence or absence of a medium level. On the contrary, the sensor does not react to remnants and coatings of viscous media on the measuring electrode.

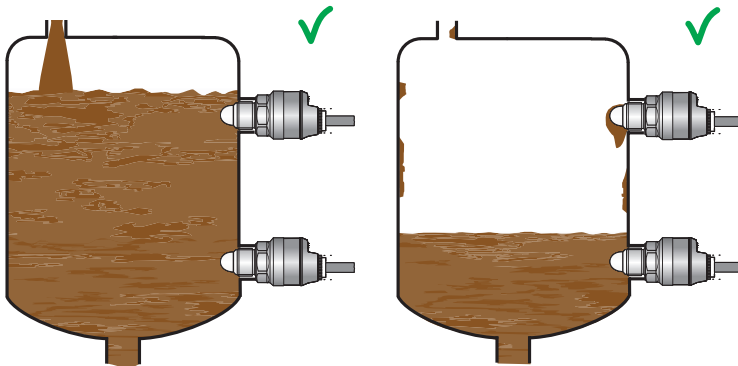
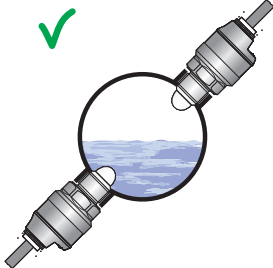
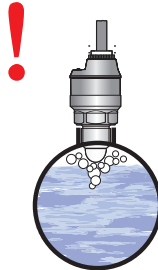

Fig. 1: Side installation of sensors into a tank with viscous medium

It is recommended to install sensors in a horizontal pipe **inclined from the side**.



Upon vertical installation of the sensor in a pipe, pay attention to potential formation of air pockets,



or adhering remnants of liquid at the bottom of the pipe.

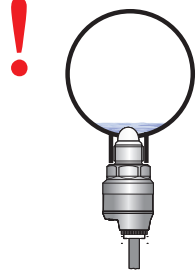

Fig. 2: Installation of the sensor in a pipe

In the case of **side wall mounting**, it is necessary to avoid long fitting tubes, where sensed medium could remain. We recommend mounting the sensor so that the whole measuring electrode is inside the tank.

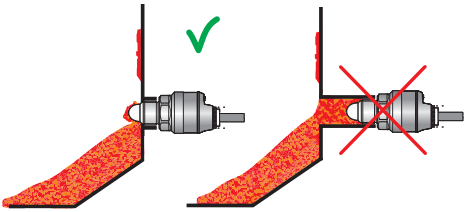

Fig. 3a: Correct and incorrect installation with a long tube

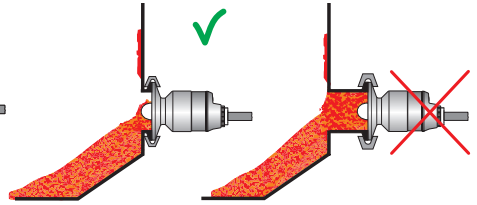

Fig. 3b: Correct and incorrect installation with a long tube for process connection with Tri-Clamp



Small Tri-clamp (ø 34 mm), only for liquids with low viscosity.

Installation of the sensor for reliable checking of the level of a liquid with foam on the surface. Sensitivity of the sensor can be set to detect the liquid interface with foam. After a drop in the liquid level, the sensor does not react to coatings of foam on the electrode.

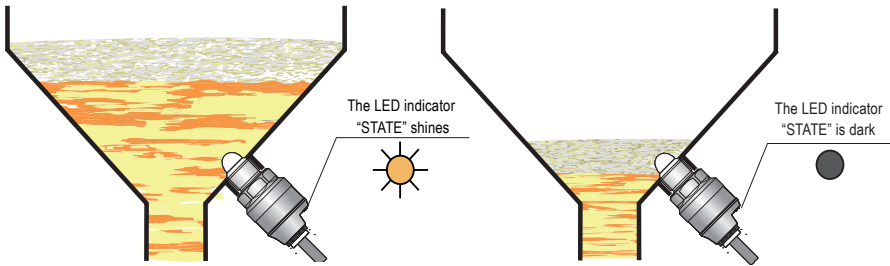

Fig. 4: Monitoring the level of foam media

The sensor can be mounted in a tank or at medium inlets. After setting to the level of the given media the sensor does not react to the current of flowing medium.

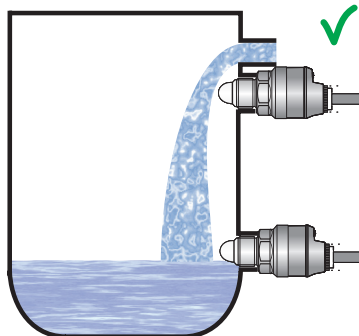

Fig. 5: Option of mounting the sensor in the medium inlet

6. ELECTRICAL CONNECTION

A sensor with PNP output can be loaded only by resistive or inductive load. The positive pole of the supply voltage (+U) is connected to the brown wire *BN* or pin connector no.1, the negative pole (0V) is connected to the blue wire *BU* or pin connector no. 3 and load on the black wire *BK* or pin connector no. 4. The capacitive loads and low resistance loads (bulb) are evaluated by the sensor as a short circuit.

Connection diagrams are listed in Figures 6, 7.

Connection using connector socket shows in Figure 9.

Sensors RFLS-35 with type of cable outlet A, B, V, D or H are connected to assessing units permanently connected by PVC cable. Design diagrams are provided in images 6, 7.

Sensors RFLS-35 with connection method type C are connected to control units by means of a connector socket with compression cable (length 2 or 5 m), or by means of dismantable connector socket without cable (see accessories), connector socket is not part of the sensor. In this case the cable is connected to the inside pins of the socket according to Figure 9. The recommended diameter of this cable is 4 to 6 mm (the recommended cross-sectional area is 0.5 to 0.75 mm²).

The connection of the sensor to the connecting device is performed using a suitable three wire (variant N) or two wire (variant Xi and XiM) cable. The length of the cable for the Xi and XiM variations must be selected with respect to the maximum permitted parameters (usually inductance and capacity) of the outside intrinsically safe circuit of supply units (NSSU, NDSU, NLCU).

In the event that dismantable connector sockets are used, the outer diameter of the cable is max. 6 mm.

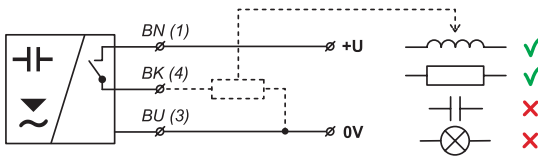

Fig. 6: PNP output type sensor connection

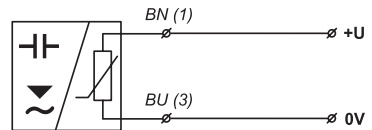

Fig. 7: NAMUR type sensors connection (variants Xi and XiM)

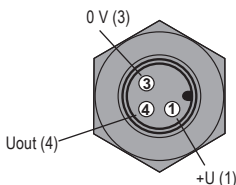

Fig. 8: Connection of the connector socket on sensor

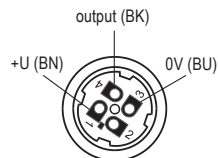

Fig. 9: Inside of the connector socket (type ELWIKA or ELKA)

Legend:

(1,...) – numbers of terminals inside the connector socket
 BK – Black
 BN – Brown
 BU – Blue



Electrical connection can only be made when de-energized!

The source of the power voltage must comprise of a stabilised safe low power source with galvanic separation. In the event that a switch-mode power supply is used, it is essential that its construction effectively suppresses common mode interference on the secondary side. In the event that the switch-mode power supply is equipped with a PE safety terminal, it must be unconditionally grounded! Spark-safe devices type (RFLS-35Xi and RFLS-35XiM) must be powered from a spark-safe power source meeting the above-mentioned requirements.



In the event that the level meater (sensor) is installed in an outdoor environment at a distance greater than 20 m from the outdoor switchboard, or from an enclosed building, it is necessary to supplement the electrical cable leading to the level meater (sensor) with suitable overvoltage protection.

With regard to possible occurrence of electrostatic charge on non-conductive parts of the sensor for explosive areas (RFLS-35Xi and RFLS-35XiM, sensors must be grounded. It will be done using conductive tank, conductive lid of tank, or by the auxiliary plate electrode PDE-27.

In the event of strong ambient electromagnetic interference, paralleling of conductors with power distribution, or for distribution to distances over 30 m, we recommend grounding the level meter (see above) and using a shielded cable.

7. CONTROL ELEMENTS

Settings are performed by placing the magnetic pen on the sensitive spot marked “+” or “-” located at the end of the sensor in two modes:

1. Quick settings - the user does not know precisely to what medium the sensor should be set, he only wants to put the sensor into operation (usually upon receiving it) and check to see if the sensor is generally functional
2. Basic settings - the user has the medium available and can perform on the sensor its flooding and drainage
3. Medium window settings - the user has the medium available and can perform on the sensor its flooding and drainage

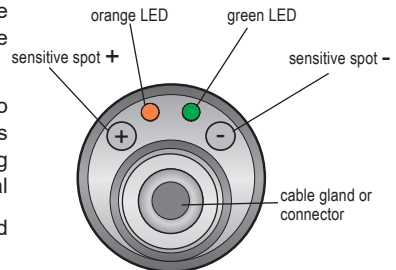



Fig. 10: Top view of sensor control elements

8. SETTINGS

8.1. QUICK SETTINGS

This function can be used for quick setting of the sensor, or in case it is not possible (or is very complicated) to change the level of the medium for setting the sensor. Suitable also before putting into operation.

A) SETTING THE MODE O (IT IS CLOSED WHEN SUBMERGED)

1. The tank is empty or the level of measured medium in the tank is in a state where the sensor electrode is no longer submerged.
2. Place the magnetic pen for **at least 5 seconds*** on the sensitive spot  of the sensor (first both LEDs illuminate, after approx. 3 seconds the orange LED will flash 3 times, and after another approx. 2 seconds the orange LED flashes again 3 times - now you can remove the magnetic pen). The sensor is now set to the mode O (it is closed when submerged).

B) SETTING THE MODE C (IT IS OPEN WHEN SUBMERGED)

1. The tank is empty or the level of measured medium in the tank is in a state where the sensor electrode is no longer submerged.
2. Place the magnetic pen for **at least 5 seconds*** on the sensitive spot  of the sensor (first both LEDs illuminate, after approx. 3 seconds the orange LED will flash 3 times, and after another approx. 2 seconds the orange LED flashes again 3 times - now you can remove the magnetic pen). The sensor is now set to the mode C (it is open when submerged).



If no other agreement the mode "O" is set on all sensors straight from the factory.



When using the function "Quick settings", the sensor does not eliminate the presence of deposits and foam on the electrode.



The manufacturer recommends performing Basic Settings as soon as possible.

**) Maximum 10 seconds.*



8.2. BASIC SETTINGS

For setting the sensitivity and switching mode, where it is possible to submerge the sensor in or remove it from the medium. When using this setting, the sensor eliminates the presence of deposits and foam on the electrode.

A) SETTING THE MODE O (IT IS CLOSED WHEN SUBMERGED)

1. Bring the level of the measured medium in the tank to a state so that the sensor electrode would be covered.
2. Place the magnetic pen for **at least 2 seconds**** on the sensitive spot  of the sensor (until both LEDs illuminate) and then remove the magnetic pen. Settings are confirmed by three flashes of the orange LED.
3. Bring the level of the measured medium in the tank to a state so that the sensor electrode would be uncovered. Leave possible deposits on the electrode.
4. Place the magnetic pen for **at least 2 seconds**** on the sensitive spot  of the sensor until both LEDs illuminate and then remove the magnetic pen. Settings are confirmed by three flashes of the orange LED.
5. Check the state of indicators:
 - If the orange LED is not illuminated and the green LED is flashing, the sensor is correctly set.
 - If alternating flashing of the orange and green LED occurs, the sensor did not recognize the limits for closing and opening. In this case, find out whether the minimum and maximum levels are not set too close to one another.

B) SETTING THE MODE C (IT IS OPEN WHEN SUBMERGED)

1. Bring the level of the measured medium in the tank to a state so that the sensor electrode would be covered.
2. Place the magnetic pen for **at least 2 seconds**** on the sensitive spot  of the sensor until both LEDs illuminate and then remove the magnetic pen. Settings are confirmed by three flashes of the orange LED.
3. Bring the level of the measured medium in the tank to a state so that the sensor electrode would be uncovered.
4. Leave possible deposits on the electrode.
Place the magnetic pen for **at least 2 seconds**** on the sensitive spot  of the sensor until both LEDs illuminate and then remove the magnetic pen. Settings are confirmed by three flashes of the orange LED.
5. Check the state of indicators:
 - If the orange LED is illuminated and the green LED is flashing, the sensor is correctly set.
 - If alternating flashing of the orange and green LED occurs, the sensor did not recognize the limits for closing and opening. In this case, find out whether the minimum and maximum levels are not set too close to one another and possible repeat the settings.



For safety reasons, we recommend setting the mode "O" for level sensing (the sensor is closed upon immersion). It is for failure safety reasons – eventual failure of sensor behaves similarly as an exceeding of the limit state. Analogically, for the maximum level it is recommended to set the mode "C" (the sensor is open upon immersion).

***) Maximum 4 seconds.

8.3. SETTINGS „MEDIUM WINDOW” - MEDIA DIFFERENTIATION FUNCTION

To set the sensitivity and switching mode for the required medium. With this setting, the sensor does not react to being submerged in a medium with a different permittivity.

A) SETTING THE MODE O (I.E. WHEN SUBMERGED IN THE REQUIRED MEDIUM, THE SENSOR IS CLOSED)

1. Bring the level of the measured medium in the tank to a state so that the sensor electrode would be covered.
2. Place the magnetic pen for **at least 10 seconds** on the sensitive spot \oplus sensor LEDs are lit, after approx. 3 seconds the orange LED will flash 3 times, and after another approx. 2 seconds the orange LED flashes again 3 times, and after another 5 s the orange LED flashes again 3 times - now the magnetic pen can be removed).
The sensor is now set to mode O (it is unswitched when submerged in the required medium).
3. Check the state of indicators:
 - If the orange LED is not illuminated and the green LED is flashing, the sensor is correctly set.

B) SETTING THE MODE C (I.E. WHEN SUBMERGED IN THE REQUIRED MEDIUM, THE SENSOR IS OPEN)

1. Bring the level of the measured medium in the tank to a state so that the sensor electrode would be covered
2. Place the magnetic pen for **at least 10 seconds** on the sensitive spot \ominus sensor (first both LEDs are lit, after approx. 3 seconds the orange LED will flash 3 times, and after another approx. 2 seconds the orange LED flashes again 3 times, and after another 5 seconds the orange LED flashes again 3 times - now the magnetic pen can be removed).
The sensor is now set to mode C (it is unswitched when submerged in the required medium).
3. Check the state of indicators:
 - If the orange LED is not illuminated and the green LED is flashing, the sensor is correctly set.

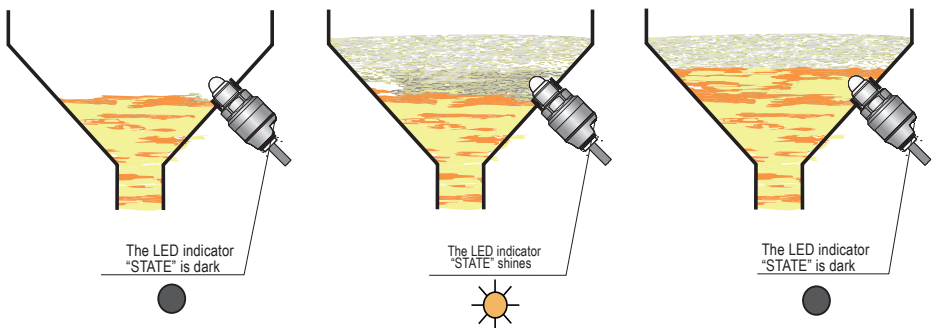
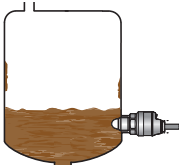

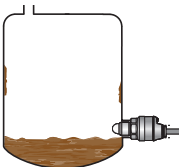

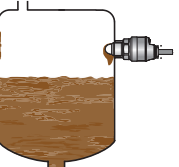

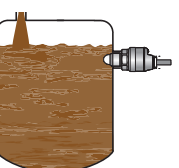



Fig 11: Mode "Medium window" - only detection of required medium (for example: only beer foam, beer and air are ignored)

9. FUNCTION AND STATUS INDICATION

LED indicator	colour	function
"RUN"	green	<p>Measuring function indication</p> <p>flashing – (approx. 0.4 s) – correct function of level detection</p> <p>dark – incorrect installation or malfunction.</p> <p>alternating flashing of the green and orange LED – error in settings</p> <p>simultaneous shine of green and orange LED – when applying the mag. pen, when the setting is confirmed</p>
"STATE"	orange	<p>Settings indication</p> <p>permanent shine – the sensor is closed</p> <p>dark – the sensor is open</p> <p>3 short flashes – settings confirmed</p> <p>alternating flashing of the green and orange LED – error in settings</p> <p>simultaneous shine of green and orange LED – when applying the mag. pen, when the setting is confirmed</p>

	level state	mode	output state	state indicator
minimum level sensing		O	CLOSED (in type N)	 (illuminated)
			HIGHER CURRENT (in type Xi)	
		O	OPEN (in type N)	 (not illuminated)
			LOWER CURRENT (in type Xi)	

	level state	mode	output state	state indicator
maximum level sensing		C	CLOSED (in type N)	 (illuminated)
			HIGHER CURRENT (in type Xi)	
		C	OPEN (in type N)	 (not illuminated)
			LOWER CURRENT (in type Xi)	

For safety reasons, we recommend using the setting of the mode "O" for min. level sensing (the sensor is closed upon immersion). It is for failure safety reasons – eventual failure of sensor behaves similarly as an exceeding of the limit state. Analogically, for the max. level it is recommended to set the mode "C" (the sensor is open upon immersion).

10. ORDER CODE

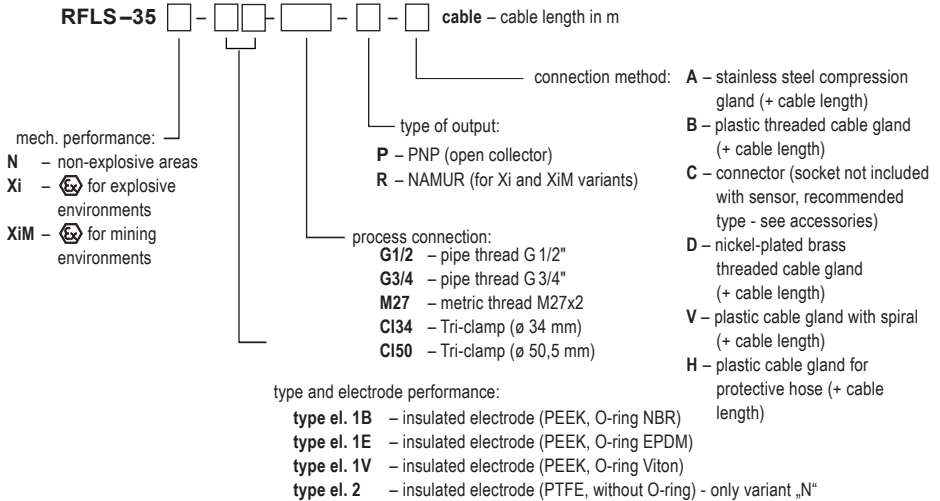

11. CORRECT SPECIFICATION EXAMPLES

RFLS-35N-2-CI50-P-B cable 5 m

(N) designed for normal areas; (2) insulated electrode PTFE; (CI50) process connection Tri-clamp (ø 50,5 mm); (P) output type PNP; (B) plastic cable gland.

RFLS-35Xi-1E-G1/2-R-C

(Xi) Explosion-proof performance; (1E) insulated electrode with O-ring EPDM; (G1/2) process connection place by thread G1/2"; (P) Output type NAMUR; (C) connector.

12. ACCESSORIES

standard – included in the sensor price

- 1 pcs. magnetic pen MP-8
- 1 pcs. seal (asbestos free)

optional – for a surcharge

(see catalogue sheet of accessories)

- cable (over the standard length 2m)
- connector socket (type ELWIKa or ELKA)
- standard steel welding flange or stainless steel welding flange
- protective hose (for type of cable outlet H)
- stainless steel fixing nut
- various types of seals (PTFE, Al, etc.)

13. SAFETY, PROTECTIONS, COMPATIBILITY AND EXPLOSION PROOF

The level sensor is equipped with protection against electric shock on the electrode, reverse polarity, output current overload, short circuit and against current overload on output.

Protection against dangerous contact is provided by low safety voltage according to 33 2000-4-41. Electromagnetic compatibility is provided by conformity with standards EN 55022/B, EN 61326-1, EN 61000-4-2 to -6.

Explosion proof RFLS-35Xi (XiM) is provided by conformity with standards EN 60079-0, EN 60079-11, EN 60079-26. Explosion proof RFLS-27Xi (XiM) is verified FTZÚ – AO 210 Ostrava – Radvanice: FTZÚ 16 ATEX 0139X.

A declaration of conformity was issued for this device in the wording of Act No. 90/2016 Coll., as amended. Supplied electrical equipment matches the requirements of valid European directives for safety and electromagnetic compatibility.

Special conditions for safe use of variants RFLS-35Xi and RFLS-35XiM

Sensors RFLS-35Xi and RFLS-35XiM are intended for connection to approved intrinsically safe supply units (insulating transducers) with galvanic separation. In the event that devices without galvanic separation (Zener barriers) are used, it is necessary to balance the potential between the sensor, resp. water level meter and the grounding barrier location.

The limit output parameters of intrinsically safe supply units (insulating transducers) must correspond to the limit input parameters of the sensor, resp. level meter. When assessing intrinsically safety of circuits, it is necessary to also take into consideration the parameters of the connected cable (namely its induction and capacity).

Design RFLS-35Xi can be used in zone 0.

Design RFLS-35XiM it is necessary to observe that temperature of any surface of apparatus, when coal dust can from a layer, do not exceed 100°C.

14. USE, MANIPULATION AND MAINTENANCE

The level meter does not require any personnel for its operation. Maintenance of this equipment consists in verification of integrity of the level meter and of the supply cable.



It is forbidden to make any changes or interventions to the RFLS-35 sensor without the consent of the producer. Any repairs must only be carried out by the producer or authorized service organisations.

Assembly, installation, commissioning, service and maintenance of the RFLS-35 level sensor must be carried out in accordance with this manual and the provisions of valid standards for the installation of electrical equipment must be complied with.

15. GENERAL, CONDITIONS AND WARRANTY

Dinel, s.r.o. guarantees for the period of three (3) years that the product has the characteristics as mentioned in the technical specification.

Dinel, s.r.o. is liable for defects ascertained within the warranty period and were claimed in writing.

This guarantee does not cover the damages resulting from misuse, improper installation or incorrect maintenance.

This guarantee ceases when the user or the other person makes any changes on the product or the product is mechanically or chemically damaged, or the serial number is not readable.

The warranty certificate must be presented to exercise a claim.

In the case of a rightful complaint, we will replace the product or its defective part. In both cases, the warranty period is extended by the period of repair.

16. MARKING OF LABELS

Labels for device of the type **RFLS-35N-__-__-P-__**

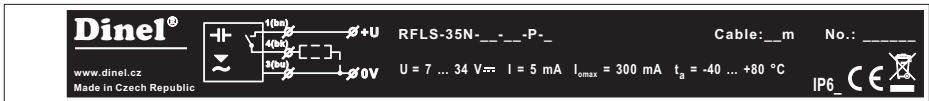

Symbol of producer: logo Dinel®

Internet address: www.dinel.cz

Country of origin: Made in Czech Republic

Connection scheme and labelling of wires: +U, 0 V

Level meter type: RFLS-35N-__-__-P-__

Cable length: Cable: __ m

Serial number: Ser. No.: _____ – (from the left: production year, serial production number)

Supply voltage: U = 7 ... 34 V =

Supply current: I = 5 mA

Maximum output current: I_{omax} = 300 mA

Ambient temperature range: t_a = -40 ... +80 °C

Protection class: IP6_ (Protection class according to electrical connection)

Compliance mark: CE

Electro-waste take-back system mark:

Labels for device of the type **RFLS-35Xi**

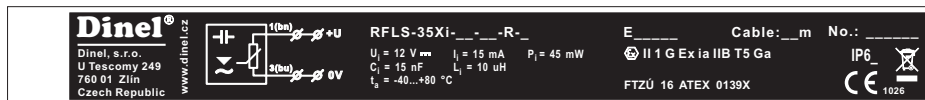

Symbol of producer: logo Dinel®

Contact: Dinel, s.r.o., U Tescomy 249, 76001 Zlín, Czech Republic, www.dinel.cz

Connection scheme and labelling of wires: +U, 0 V

Level meter type: RFLS-35Xi-__-__-R-__ E_____

Cable length: Cable: __ m

Serial number: Ser. No.: _____ (from the left: production year, serial production number)

Limit operating parameters: $U_i = 12 \text{ V}$, $I_i = 15 \text{ mA}$; $P_i = 45 \text{ mW}$; $C_i = 15 \text{ nF}$; $L_i = 10 \text{ uH}$

Ambient temperature range: $t_a = -40 \dots +80 \text{ }^\circ\text{C}$

Label of non-explosive device:

Performance: II 1 G Ex ia IIB T5 Ga

Number of certificate of intrinsically safety: FTZÚ 16 ATEX 0139X

Protection class: IP6__

Compliance mark: No. of authorized person examining control of system quality: 1026

Electro-waste take-back system mark:

Labels for device of the type **RFLS-35XiM**

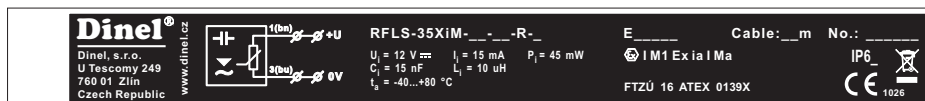

Symbol of producer: logo Dinel®

Contact: Dinel, s.r.o., U Tescomy 249, 76001 Zlín, Czech Republic, www.dinel.cz

Connection scheme and labelling of wires: +U, 0 V

Level meter type: RFLS-35XiM-__-__-R-__ E_____

Cable length: Cable: __ m

Serial number: Ser. No.: _____ (from the left: production year, serial production number)

Limit operating parameters: $U_i = 12 \text{ V}$, $I_i = 15 \text{ mA}$; $P_i = 45 \text{ mW}$; $C_i = 15 \text{ nF}$; $L_i = 10 \text{ uH}$

Ambient temperature range: $t_a = -40 \dots +80 \text{ }^\circ\text{C}$

Label of non-explosive device:

Performance: I M1 Ex ia I Ma

Number of certificate of intrinsically safety: FTZÚ 16 ATEX 0139X

Protection class: IP6__

Compliance mark: No. of authorized person examining control of system quality: 1026

Electro-waste take-back system mark:



Size of labels 70 x 20 mm, the size shown does not correspond to reality.

17. TECHNICAL SPECIFICATIONS

BASIC TECHNICAL DATA

Supply voltage (variant RFLS-35N)		7 ... 34 V DC
Power consumption (variant RFLS-35N)		max. 5 mA DC
Max. switching current (PNP output)		300 mA
Residual voltage – ON state		max. 1,5 V
Coupling capacity (housing - power) / dielectric strength		5 nF / 500 V AC (50 Hz)
Ambient temperature range:		-40 ... +80 °C
Protection class	type RFLS-35_ _ _-C- _ _	IP 67
	type RFLS-35_ _ _-A(B,V,H,D)- _ _	IP 68
Cable (versions with cable outlets)	Variant (P,N)	PVC 3 x 0,5 mm ²
	Variant (Xi, XiM)	PVC 2 x 0,75 mm ²
Weight (without cable)		cca 0,15 kg

ELECTRICAL PARAMETERS – variant Xi and XiM

Power supply voltage	8 ... 9 V DC
Current consumption (disconnected/ connected) – NAMUR	≤ 1 mA / ≥ 2,2 mA
Max. internal values	Ui = 12 VDC; Ii = 15 mA; Pi = 45 mW; Ci = 15 nF; Li = 10 μH
Cables LC values	typic C < 150 pF/m typic L < 0,8 μH/m

USED MATERIALS

part of the sensor		standard material *
Housing		stainless steel W.Nr. 1.4404 (AISI 316L)
End of sensor		stainless steel W.Nr. 1.4301 (AISI 304)
electrode coating	type el. 1 type el. 2	PEEK PTFE
Sealing O-ring	RFLS-35_ _-1B RFLS-35_ _-1E RFLS-35_ _-1V RFLS-35_ _-2	NBR EPDM (FPM) Viton –
Cable gland (variant "A")		stainless steel W.Nr. 1.4571 / NBR
Cable gland (variant "B", "V", "H")		plastic PA / NBR
Cable gland (variant „D")		nickel-plated brass / PA
Connector M12 (variant "C")		nickel-plated brass / PA

* Verify chemical compatibility with the media. Upon agreement it is possible to select a different type of material.

PROCESS CONNECTION

type	size	marking
Pipe thread	G 1/2"	G1/2
Pipe thread	G 3/4"	G3/4
Metric thread	M27x2	M27
Jointless connection (Tri-Clamp) *	ø 34 mm ø 50,5 mm	CI34 CI50

* only for type electrode 2

WORKING AREAS AND AREA CLASSIFICATION (EN 60079-0, EN 60079-10-1)

Level meter performance	Type of electrode	Device classification
RFLS-35N	All types	Basic performance for non-explosive atmospheres.
RFLS-35Xi	1B, 1E, 1V	Intrinsically safe explosion-proof performance for use in hazardous areas (explosive gas atmospheres or explosive atmospheres with dust) ⊕ II 1 G Ex ia IIB T5 Ga; with intrinsically safe supply units, whole sensor zone 0.
RFLS-35XiM	1B, 1E, 1V	Intrinsically safe explosion-proof performance for use in mines with the occurrence of methane or coal dust ⊕ IM1 Ex ia I Ma with intrinsically safe supply units.

TYPE OF OUTPUT

Output	Variants
PNP (PC; PO)	N
NAMUR (RC; RO)	Xi (XiM)

TEMPERATURE AND PRESSURE DURABILITY – variant N, Xi and XiM

design variant	temperature tp	temperature ta	maximum overpressure
RFLS-35N-1B (1E)	-40°C ... +105°C	-40°C ... +80°C	10 MPa
RFLS-35Xi(XiM)-1B (1E)	-40°C ... +100°C	-40°C ... +80°C	10 MPa
RFLS-35N-1V	-20°C ... +105°C	-40°C ... +80°C	10 MPa
RFLS-35Xi(XiM)-1V	-20°C ... +100°C	-40°C ... +80°C	10 MPa
RFLS-35N-2	-40°C ... +105°C	-40°C ... +80°C	5 MPa to 50°C 2,5 MPa over 50°C

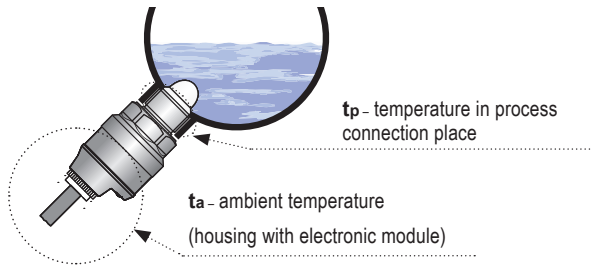

18. PACKINGS, SHIPPING AND STORAGE

The device RFLS-35 is packaged in a polyethylene bag, and the entire consignment is placed into a cardboard box. A suitable filler material is used in the cardboard box to prevent mechanical damage during transport. Remove the device from the packaging only just before using, thereby protecting it from potential damage.

A forwarding company will be used to ship goods to the customer. Upon prior agreement, ordered goods can be picked up in person at company headquarters. When receiving, please check to see that the consignment is complete and matches the order, or to see if any damage has occurred to the packaging and device during transport. Do not use a device clearly damaged during transport, but rather contact the manufacturer in order to resolve the situation.

If the device is to be further shipped, it must be wrapped in its original packaging and protected against impact and weather conditions.

Store the device in its original packaging in dry areas covered from weather conditions, with humidity of up to 85 % without effects of chemically active substances. The storage temperature range is $-10\text{ }^{\circ}\text{C}$ to $+50\text{ }^{\circ}\text{C}$.

Dinel[®]

industrial electronics

Dinel, s.r.o.
U Tescomy 249
760 01 Zlín
Czech Republic

Phone: +420 577 002 002
Fax: +420 577 002 007
E-mail: sale@dinel.cz

www.dinel.cz

Find the updated version at www.dinel.cz

version: 05/2018

