



ANTENNA RADAR LEVEL METER **ARLM – 70**



TABLE OF CONTENTS

| | |
|---|----|
| 1. Basic description | 4 |
| 2. Range of applications | 4 |
| 3. Dimensional drawing | 5 |
| 4. Installation and putting into operation | 6 |
| 5. Mechanical mounting | 6 |
| 6. Electrical connection | 9 |
| 7. Examples of ARLM-70 connection | 10 |
| 7.1. Wiring diagram of the level meter with current output and PCU unit | 10 |
| 7.2. Wiring diagram of the level meter with current output and PCU unit, MULTI DROP | 10 |
| 7.2. Wiring diagram of the level meter with current output and PDU unit | 11 |
| 7.2. Wiring diagram of the level meter with current output and MGU unit | 11 |
| 8. Setting elements | 12 |
| 9. Operation and Settings | 13 |
| 9.1. Basic settings | 12 |
| 9.2. Service settings | 17 |
| 9.3. Additional functions | 18 |
| 10. Protocol HART® | 21 |
| 11. Function and status indication | 22 |
| 12. Order code | 22 |
| 13. Accessories | 23 |
| 14. Safety, protection, compatibility and explosion proof | 23 |
| 15. Use, manipulation and maintenance | 23 |
| 16. General conditions and warranty | 24 |
| 17. Marking of labels | 24 |
| 18. Technical specifications | 25 |
| 19. Packing, shipping and storage | 26 |
| 20. Menu structure | 27 |

USED SYMBOLS

To ensure maximum safety of control processes, we have defined the following safety instructions and information. Each instruction is labelled with the appropriate pictogram.



Alert, warning, danger

This symbol informs you about particularly important instructions for installation and operation of equipment or dangerous situations that may occur during the installation and operation. Not observing these instructions may cause disturbance, damage or destruction of equipment or may cause injury.



Information

This symbol indicates particularly important characteristics of the device.



Note

This symbol indicates helpful additional information.

SAFETY



All operations described in this instruction manual have to be carried out only by trained personnel or an accredited person. Warranty and post warranty service must be exclusively carried out by the manufacturer.

Improper use, installation or set-up of the level meter can result in crashes in the application (overflowing of the tank or damage of system components).

The manufacturer is not responsible for improper use, losses of work caused by either direct or indirect damage, and for expenses incurred during installation or use of the level meter.

1. BASIC DESCRIPTION

The ARLM-70 „Amanda“ radar level meter works on the FMCW (frequency modulated continuous wave) principle with a frequency of 25 GHz (K-Band).

The level meter is equipped with a compact covered funnel antenna. The antenna cover prevents dirt, vapors and gases from entering the antenna.

The ARLM-70 is intended for measuring the level of liquid and pasty substances.

The level meter is two-wire with a current output of 4 ... 20 mA with HART communication. The measuring range is within 0.3 ... 20 m.

2. RANGE OF APPLICATIONS

Non-contact radar level meters with an antenna are suitable for continuous level measurement at medium and longer distances, liquids and pasty substances..

They can be used both in various closed tanks, containers, in semi-open sumps, and in open space. Their use is suitable where their advantages are fully applied:

1. non-contact measurement
2. the independence of the measurement from the temperature and pressure of the atmosphere above the surface
3. the possibility of measuring even in a vacuum
4. the possibility of measuring even in aggressive vapors
5. the measurement is independent of the medium parameters

3. DIMENSIONAL DRAWING

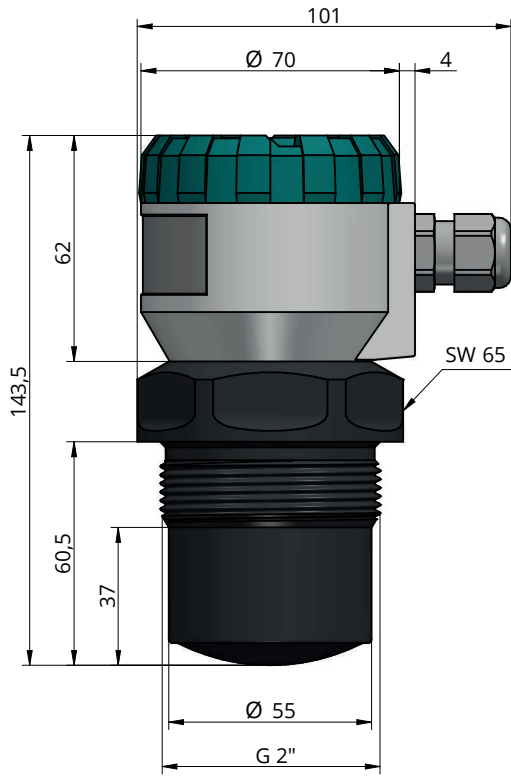

4. INSTALLATION AND PUTTING INTO OPERATION

Please follow next 3 steps:

- **MECHANICAL MOUNTING** - SEE CHAPTER 5
- **ELECTRICAL CONNECTION** - SEE CHAPTER 6 AND 7
- **SETTINGS** - SEE CHAPTER 8 AND 9

5. MECHANICAL MOUNTING

- Install the level meter in the **vertical position** into the upper lid of the tank or reservoir using a welding flange, a fastening nut or a flange so that the level meter axis can be perpendicular to the level of the measured liquid (Fig. 1).
- The min. **dimensional parameters** to install the level meter into a lid or a ceiling of a tank are given in Fig. 3.
- When installing in an **open channel** (reservoir, drain etc.), install the level meter onto a bracket as close as possible to the expected max. level.
- The reference plane for the measurement is the lower edge of the transducer (Fig.2). In connection with the measurement principle, no signals **reflected** in the area immediately under the level meter can be evaluated. **The zone** (Fig. 2) determines the min. distance possible between the level meter and the highest level. The min. distances to the medium is 30 cm.
- It is necessary to install the level meter so that the bin level cannot **interfere** with the dead zone when filled up to the maximum. If the measured level interferes with the dead zone, the level meter will not work properly.

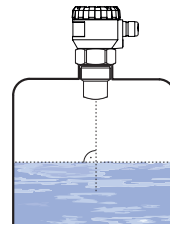

Fig. 1: Recommended installation in the tank

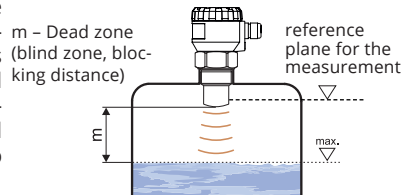

Fig. 2: Level meter dead zone

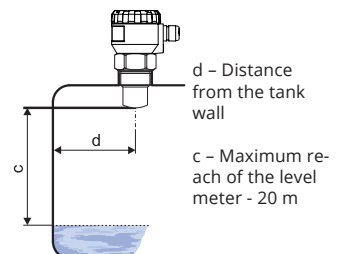

Fig. 3: Installation distance from the tank wall

| | |
|------------|-------------------------------|
| ARLM-70-20 | $d > 1/12 c$ (min. 200 mm) |
|------------|-------------------------------|

- If the maximum level in the tank interferes with the dead zone, the level meter has to be mounted into a higher **installation neck**. In this way, the tank can be filled nearly up to the maximum volume. The inner neck surface has to be even and smooth (without edges and welded joints); the inner edge should be rounded where the radio wave leaves the pipe. The neck diameter should be as large as possible but the neck height should be as low as possible. Recommended dimensions of the input neck are given in Fig. 4.

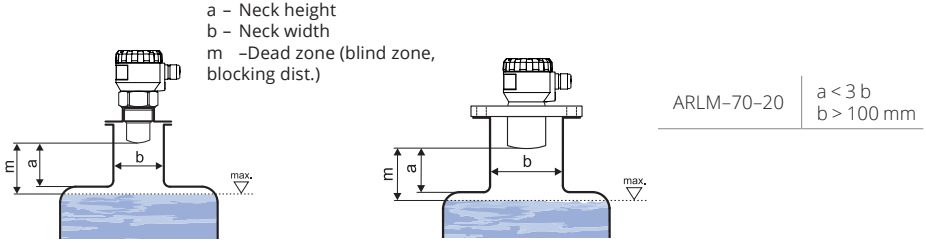

Fig. 4: Possible installation of the installation neck

- If the emitted radio waves of the level meter is affected by **near objects** (roughness on walls of the tank, various partitions, mixers etc.), it is necessary to map false reflections by activating the mode "TEACHING". In case of installed mixers, it is necessary to put the mixers to position under the level meter (direct the mixer paddle to the radio signal beam) (Fig. 5 and 6).

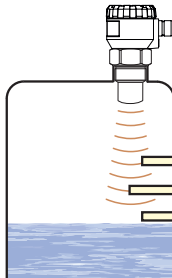

Fig. 5: False echo from obstacles in the tank

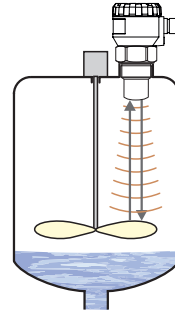

Fig. 6: False echo from the mixer paddle

- Do not install the level meter in or above the **filling** point (Fig. 7).

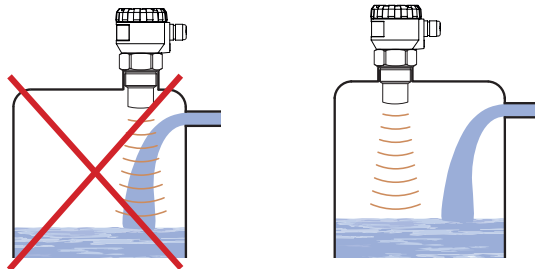

Fig. 7: Level meter installation outside the influence of filling

- During filling, mixing and other processes, **foam** can arise on the level of the measured liquid. The foam considerably absorbs the radio signal which might cause malfunction of the level meter (Fig. 9). For such cases, it is necessary to set up "SENSITIVITY" mode to "high" or contact the manufacturer if need. In case of a thin layer of foam, it is also possible to use the directional horn for improving receipt of the reflected echo.

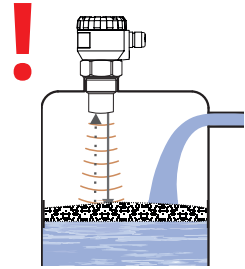

Fig. 8: Foam on the surface

- Scattering or attenuation of the radio signal can result if the level has been **moderately stirred** or **rippled** (by a mixer, coming liquid etc.). It can result in reduction of the measurement range or unreliable function of the level meter (Fig. 9).
- Rotating **mixer blades** can cause that the surface is stirred, which results in false reflections of the radio signal from the level and unreliable operation of the level meter (Fig. 10). **For a rippled or swirling level, you can use the directional horn to eliminate scattering of the radio signal.**

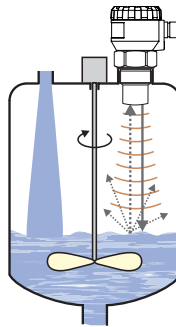

Fig. 9: Moderately stirred surface

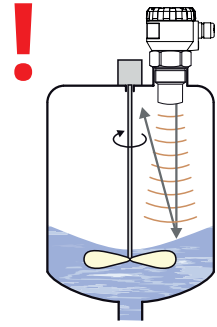

Fig. 10: Intensely stirred surface

- The level meter must not be installed in places with direct **solar radiation** and must be protected against weather effects. If the installation in places with direct solar radiation is inevitable, it is necessary to mount a **shielding cover** above the level meter (Fig. 11).
- It is suitable to run the cable under a cable bushing (obliquely down in slack) according to Fig. 12 to prevent **penetration of humidity**. Then the rain and condensing water can flow off freely.
- The cable bushing and connector have to be **sufficiently tightened** to prevent penetration of humidity.

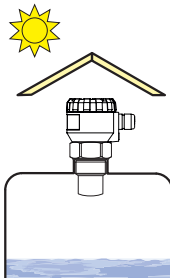

Fig. 11: Solar radiation shielding cover

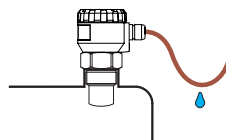

Fig. 12: Prevention to avoid intrusion of humidity

6. ELECTRICAL CONNECTION

The level meter is connected to consequential (evaluating) device with a suitable cable with the outer diameter of 6 to 8 mm using screw terminals located under the display module. The recommended cross section of cores for the current version $2 \times 0,5 \div 0,75 \text{ mm}^2$. Plus pole (+) is connected to the terminal (+), minus pole (-) to the terminal (-) and the shielding (only for shielded cables) to the terminal (\perp).

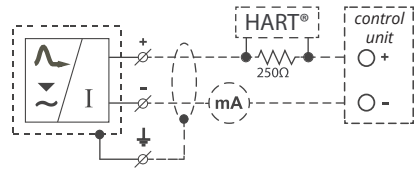

Fig. 13: Wiring diagram of the level meter with current output ARLM-70_--I

Procedure to connect the cable to the level meter:

1. Unscrew the nut of the upper transparent lid.
2. Take the upper edge of the display module and take it out carefully by mild swinging up.
3. If you cannot grasp the module, you can use a small screwdriver. Insert it as far as the seam and use from several sides to slightly lift the module.
4. Release the cable outlet and thread the stripped supply cable in.
5. Connect the cable to the screw terminals according to the diagram in Fig. 17 or 18. Firmly tighten the terminals and the cable outlet.
6. Insert the display module back into the head so that the connector is properly connected.
7. Slide silicone seal on the thread of the level meter body, then tighten the nut of the upper lid. Connect the cable to consequential device.

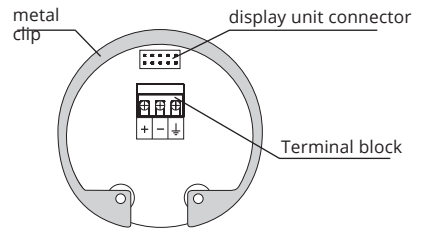

Fig. 14: Inside view of screw terminals of the level meter with current output ARLM-70_--I



Electrical connection can only be made when de-energized!

The source of the power voltage must comprise of a stabilised safe low power source with galvanic separation. In the event that a switch-mode power supply is used, it is essential that its construction effectively suppresses common mode interference on the secondary side. In the event that the switch-mode power supply is equipped with a PE safety terminal, it must be unconditionally grounded!

In the event that the sensor is installed in an outdoor environment at a distance greater than 20 m from the outdoor switchboard, or from an enclosed building, it is necessary to supplement the electrical cable leading to the sensor with suitable overvoltage protection.

In the event of strong ambient electromagnetic interference, paralleling of conductors with power distribution, or for distribution to distances over 30 m, we recommend grounding the level meter (see above) and using a shielded cable. Ground the shielding of the cable on the side of the power supply, or the shielding is possible to connect only on inside pin of the level meter marked \perp see fig. 17 and 19 (the shielding of the cable is always connected in a single location).



Measures must also be designed and implemented in the electrical installation to reduce the effects of static electricity to a safe level.

7. EXAMPLES OF ARLM-70 CONNECTION

7.1. Connection diagram of the level meter with the current output to the PCU unit

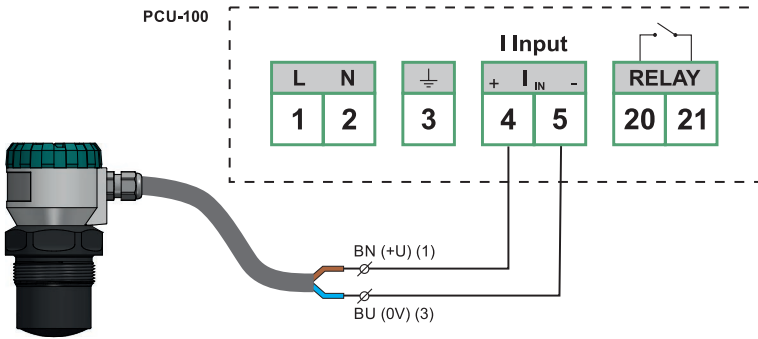

7.2. Connection diagram of the level meter with the current output to the PCU unit

Demonstration in **MULTI-DROP** mode.

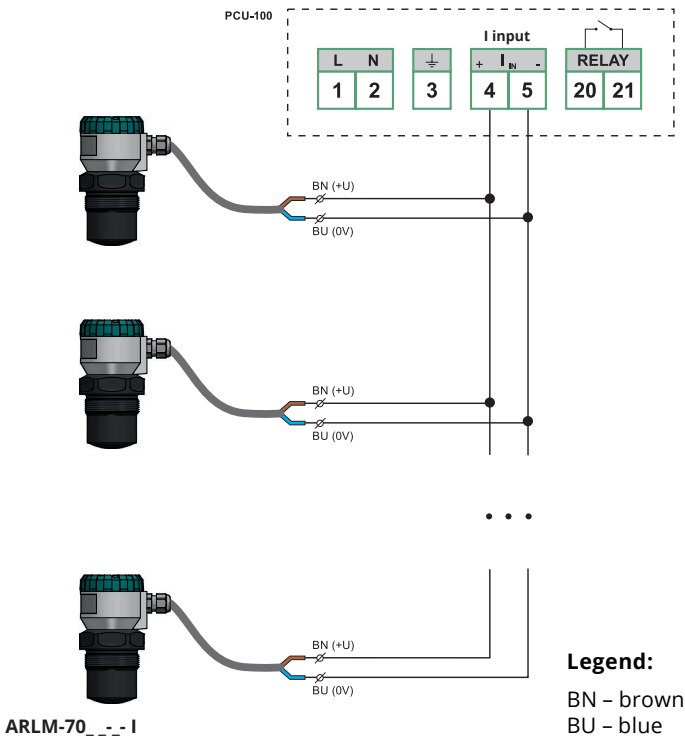

If HART® communication is in the POINT-TO-POINT mode, then only 1 level meter can be connected to the unit.

7.3. WIRING DIAGRAM OF THE LEVEL METER WITH CURRENT OUTPUT AND PDU UNIT

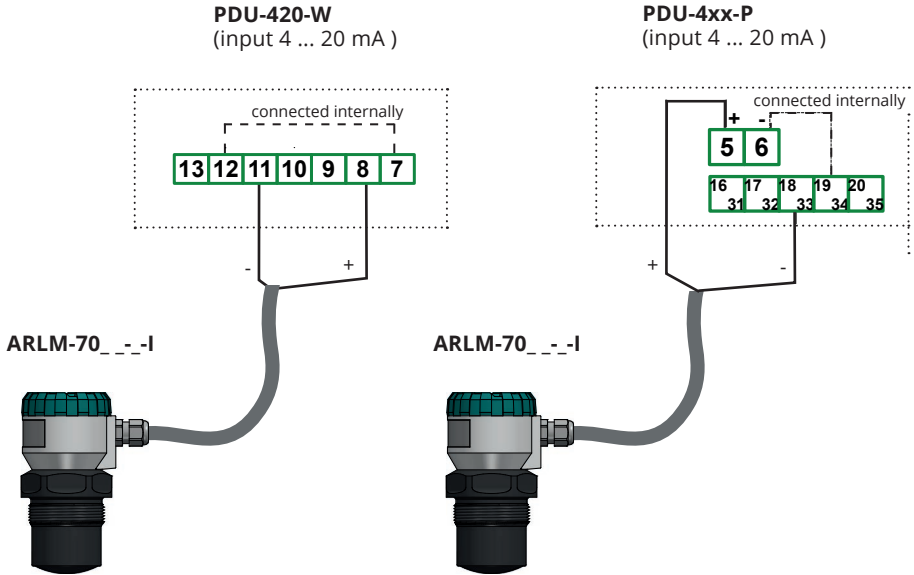

i Connection of PDU-420-W is valid for firmware version 6.00 or higher. The older versions (up to version 5.99), the level meter output +U is connected to the terminal 7 and the output 0V to the terminal 10.

7.4. WIRING DIAGRAM OF THE LEVEL METER WITH CURRENT OUTPUT AND MGU UNIT

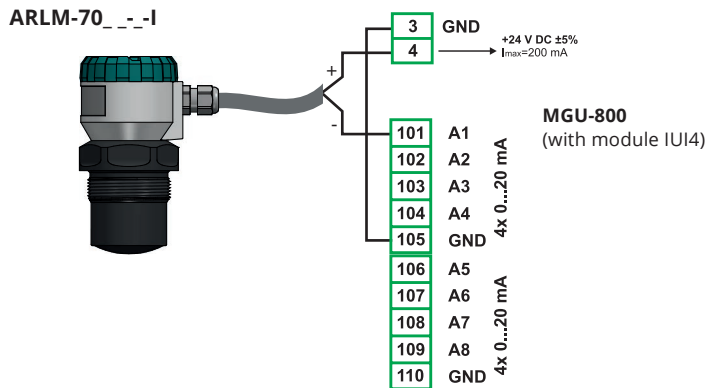

8. SETTING ELEMENTS

Settings are performed using 3 buttons located on the display module DM-70. All the settings are available in the menu of the level meter.

Button

- Set-up mode access
- Confirmation of selected item in the menu
- Move the cursor in the line
- Saving of set-up data

Button

- Move in the menu
- Change of values

Button

- Cancelling of carried out changes
- Shift one level up

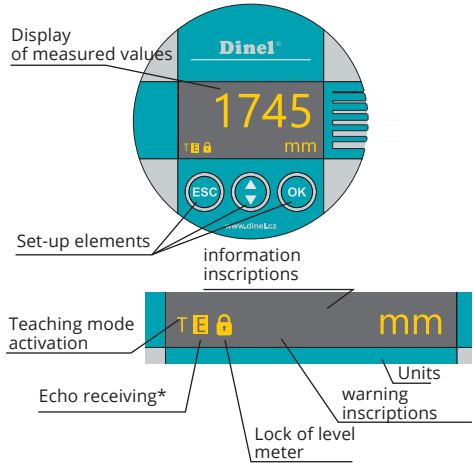

* **Slow flashing while the reflected signal (echo) is received from the measured level.**

- **Status indication (left lower corner of the display):**
 - symbol „E“** - **alternating flashing** - correct reception of the reflected wave indicating the level
 - symbol „T“** - **permanent shine** - "TEACHING" mode is activated
 - **inverse shine** - activation of the "TEACHING" mode
 - symbol ** - **permanent shine** - the level meter is locked against unauthorized setting using a password, enter password to unlock (see MENU - PASSWORD)
- **Warning inscriptions:**
 - NO ECHO** - when empty tank, after you perform the procedure TEACHING
 - level meter is not able to measure (check the media or change the sensitivity)
 - FIXED OUTPUT** - the output stream is fixed to a constant value (see DIAGNOSTIC - CURRENT)
 - LOW POWER** - low supply voltage (must be in the range - see Technical specifications)
 - NO PASSWORD** - the level meter is not protected using a password against unauthorized setting
 - NO DATA AVAILABLE** - display module doesn't communicate with the electronics of the level meter (e.g. incorrectly inserted display module into connector or measuring module is not functional).
- **Information inscriptions:**
 - DISTANCE TO LEVEL** - the display shows the current distance (see DIAGNOSTIC - DISTANCE)
 - CURRENT** - the display shows the current proud (see DIAGNOSTIC - CURRENT)



Level meter ARLM-70-_-_-_-L is supplied without the display module (display) DM-70. To setup the level meter, it is necessary to connect a display module to it (or it can be configured via HART). When the settings are completed, the display module may be disconnected and the level meter then measures without it.

9. OPERATION AND SETTING

Set the level meter using 3 buttons placed on the display module (see Chapter Set-up elements). After 5 min. of inactivity, the level meter automatically returns back to the measurement mode. If the password is active, the level meter will be also locked. The values that have not been confirmed using the button **OK** will not be saved! After the meter is locked, you cannot change the setting! When you attempt to edit, the words "NO PASSWORD" will appear on the display. How to unlock the level meter is given on pages 19. and 20.

After connection of the supply voltage to the level meter the display shows the logo "Dinel" and the text "Starting" (approx. 15 s). Then, the level meter goes to the measuring mode and the display shows the current measured value.



9.1. BASIC SETTINGS

After the first start of the level meter it is necessary to perform the basic configuration (setting of the measuring range, choice of units and possibly damping). The settings are accessible in the basic menu by pressing **OK** the "BASIC SETTINGS".

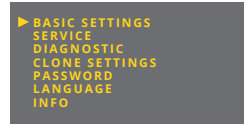

LEVEL

Here you can freely define the minimum / maximum distance of the level. Units are set in the "UNITS" menu.

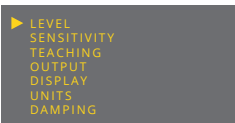

- UNITS: physical units of distance
- ACTUAL: current distance to the level
- DISTANCE TO LEVEL:
- MIN: defining the distance of the level meter from the minimum level
- MAX: defines the distance of the level meter from the maximum level

If in the bottom of the display appears (when entering the values) the inscription "OUT OF LIMITS", the value specified for the item "DISTANCE TO LEVEL" is outside the measuring range of the level meter. If the inscription "SPAN TOO SMALL" is shown, it must be specified a larger span between MIN and MAX values. For more information, see chapter "Specifications".

The decimal point position of the item 'LEVEL' is firmly set (according to the selected units).

1. Press the **OK** button to enter the menu and select "BASIC SETTINGS". Then use **↑** and **OK** to select "LEVEL".
2. The item "LEVEL" will now appear. Press **OK** and **↓** to enter the distance of the level meter to the MIN level and to the MAX level.
3. Press the **OK** button to save the data. Exit the menu by pressing the **ESC** button. The level meter will return to measuring mode.

SENSITIVITY

The setting defines the sensitivity of the level meter in three levels.

- „LOW“ – Low sensitivity in case of surrounding interferences affecting the measurement.
- „MEDIUM“ – Medium sensitivity (suitable for most applications).
- „HIGH“ – Enhanced sensitivity for measured media partly absorbing the signal (foam).



1. Pressing the button is for enter the menu, press the same button to select the item "BASIC SETTINGS". Then by pressing the buttons and is selected the item "SENSITIVITY".
2. Using the buttons and set the proper sensitivity.
3. After completion of setting pressing of the button saves the setting. Continue by pressing to exit a menu and the level meter returns to the measuring mode.

TEACHING

The mode serves for suppressing false reflections resulting from reflection of the signal from irregularities on walls of the tank, various partitions, mixers or other obstacles. The sensor starting this mode detects false reflections and save them in the memory. These false reflections will not affect the subsequent measurement (they are masked out).

TEACHING – the distance is entered to the level. This mode creates a one-time false reflection map that it stored in memory.

FACTORY DEFAULT – run if it needs to clear the false reflection map and return the level meter to factory settings.

All modes can be activated repeatedly.

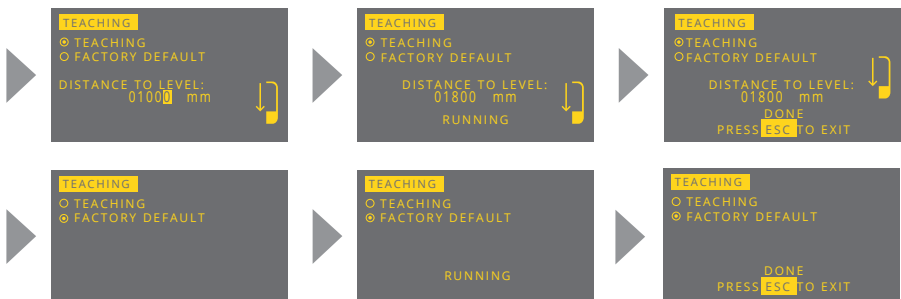
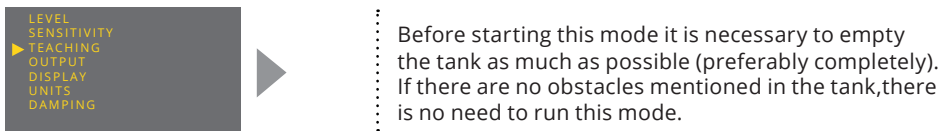

1. To enter to the menu press the same button to select "BASIC SETTINGS". Then, using and select "TEACHING".

- Now the menu item "TEACHING" is shown. After pressing the button **OK** you can select by pressing **↑** type of Teaching mode (TEACHING, or FACTORY DEFAULT). Confirmation of the mode is done with the button **OK**. Then is necessary to enter the distance to the level. If you are sure you can start the "TEACHING" procedure (false reflection mapping) by pressing **OK** button. During the mapping, the display shows flashing sign "RUNNING".
- At mode TEACHING the procedure is completely finished when you can see the inscription "DONE" and "PRESS ESC TO EXIT". It is then possible to exit the menu by pressing the button **ESC**.

In case of installed mixers, it is necessary to position the mixers under the level meter (direct the mixer blade to the radio signal beam).

Note: If there are significant obstacles in the upper half of the tank, multiple false reflections can occur especially in closed tanks. In such cases it is necessary to reduce the level in the tank as much as possible to correctly mask these possible multiple false reflections.

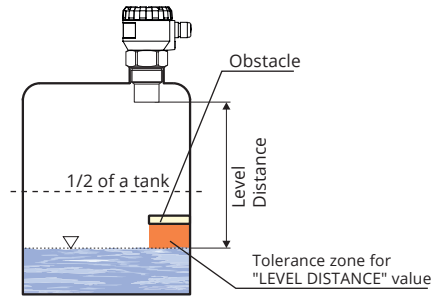
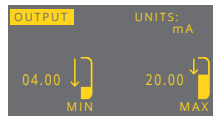

Fig. 15: Level distance zone „Set level distance“

OUTPUT



This item is displayed only for level meters with current output and is used to transfer the measured data of the level meter to current output. To the MIN values and MAX entered in the LEVEL item are assigned current limit values.

By default, the level meter is preset that the value of the distance to the minimum (resp. maximum) level is assigned a current value of 4 mA (resp. 20 mA).

- To enter to the menu press **OK** the same button to select "BASIC SETTINGS". Then, using **↑** and **OK** select "OUTPUT".
- Then by pressing **OK** and **↑** enter the limit values of current.
- By pressing **OK** button save the data. By next presses of the button **ESC** leave the menu. The level meter returns to measurement mode.

DISPLAY



This item is used to convert the measured data of the level meter to display the value on the display. The MIN and MAX values entered in the LEVEL item are assigned the MIN and MAX limit values in this DISPLAY item. By default, the level meter is preset so that the displayed value of 0% (resp. 100%) is assigned to the value of the distance from the minimum (resp. maximum) level.

1. To enter to the menu press **OK** the same button to select "BASIC SETTINGS". Then, using **UP** and **OK** select "DISPLAY".
2. Then by pressing **OK** and **UP** enter the decimal point position of the item "DISPLAY", which is freely adjustable then by pressing **OK** and **UP** enter showed value on the display.
3. By pressing **OK** button save the data. By next presses of the button **ESC** leave the menu. The level meter returns to measurement mode.

UNITS

Level meter can process and convert a large number of different **physical values**. The setting is done in the item "UNITS".



1. To enter to the menu press **OK** the same button to select "BASIC SETTINGS". Then, using **UP** and **OK** select "UNITS".
2. Now the menu item "UNITS" is shown. By pressing the **OK** and **UP** button make the settings of individual items.
3. By pressing **OK** button save the data. By next presses of the button **ESC** leave the menu. The level meter returns to measurement mode.

LEVEL: Unit selection (mm, cm, m, in, ft)

DISPLAY: The unit showed on the display (% , mm, cm, m, in, ft, l, hl, m³, gal, bbl, mA)

DAMPING

Setting the measurement response speed. The function is suitable for suppressing display fluctuations during rapid or sudden changes in the level state (stirred level). The subsequent reaction time will depend on the exponential course. Damping with a defined delay in seconds indicates the time when the exponential waveform reaches 2/3 of its maximum value.



The damping time can be set between 0 and 99 s.

1. Press the **OK** button to enter the menu, with the same button the item "BASIC SETTINGS" is selected. Subsequently, the "DAMPING" item is selected using the **UP** and **OK** buttons.
2. "DAMPING" is now displayed. Use the **OK** and **UP** buttons to adjust the damping.
3. After finishing the settings, the data is saved by pressing the **OK** button. By repeated pressing of the **ESC** button, the menu will be exited and the level meter will return to the measuring mode.

9.2. SERVICE SETTINGS

In the service settings, it is possible to set the behavior for error states or HART® communication. Here it is also possible to reset the sensor to its default state or reset it. The settings are accessible in the main menu under the item "SERVICE".

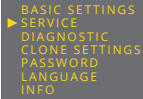

BASIC SETTINGS
▶ SERVICE
▶ DIAGNOSTIC
CLONE SETTINGS
PASSWORD
LANGUAGE
INFO

FAILURE MODE

This item is a part of the level meter with a ARLM-70_--_I current output. It defines the output current of the level meter in case of echo loss ("NO ECHO").

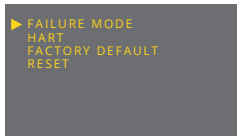

NO ECHO: Current in case of echo loss

The values can be set in five steps:
3,75 mA – 4 mA – 20 mA – 22 mA –
LAST VALUE (last measured data).

HART

This item is a part of the level meter with a ARLM-70_--_I current output. Settings for HART® protocol (point to point, multidrop) and addresses for the multidrop mode. In multidrop mode, up to 15 devices can be connected to a single two wire cable.

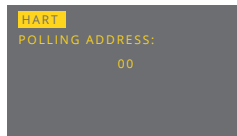

In the case of address "00", the **point to point** mode is activated. The range "01" to "15" is reserved for addresses in the **multidrop** mode (current is fixed at 4 mA).

FACTORY DEFAULT

Load the factory default settings to the level meter. They are loaded by pressing button .

The default settings table is provided on pg. 26.



After pressing button  the message **"PROCESSING"** will appear for a short time. After the default values are loaded, the title **"FINISHED"** and text **"Press Esc to exit"**.

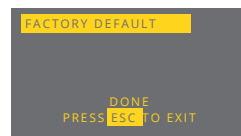

RESET

Complete restart of the level meter. The same effect has also a short-time interruption of the supply voltage. To enable the resetting, press the button .



During the restart process, "RUNNING" will be displayed. Then the level meter will be automatically turned off and on.

9.3. ADDITIONAL FUNCTIONS

Additional functions include modes for diagnostics or for copying settings. Furthermore, locking of modifications with a password, language mutation and information about the version of the level meter (display module). All these functions are accessible from the main menu.

DIAGNOSTIC

DISTANCE TO LEVEL : display the actual value of the distance from the sensor to the level of the measured medium.

CURRENT: display the actual output current; only for level meter with a ARLM-70_--_-I current output

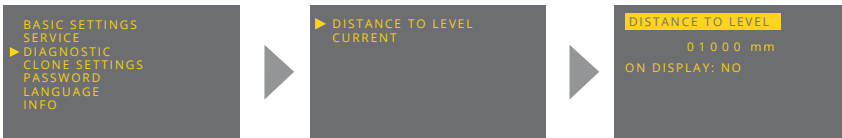

ON DISPLAY:

YES (the main display shows value from diagnostics: distance to level, current)

NO (the main display shows the standard measured value set by the DISPLAY item in the BASIC SETTINGS)

SET VALUE: setting the current to a fixed value (3,75 mA - 4 mA - 12 mA - 20 mA - 22 mA - MEASUR.)

If parameter MEASUR. is selected, current corresponds with the measured value)

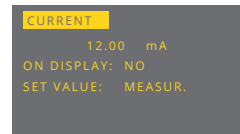

Option SET VALUE can be used to diagnose the connected evaluation device.

If the current is set (fixed) to a fixed value, the main display shows the FIXED OUTPUT and in section SET VALUE a title appears FIXED.

CLONE SETTINGS

This mode is intended for **copying** of the level meter (ARLM-70 body) **configuration into the display module** (DM-70) and back. The display module can then be removed from the level meter body and put into another level meter and make the settings transfer there (cloning).

The "CLONE SETTINGS" mode transfers all data, excluding setting of the "Teaching" and HART® (POLLING ADDRESS) or MODBUS (ADDRESS).

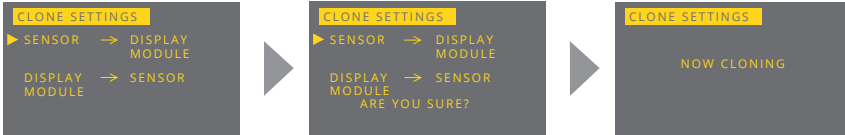
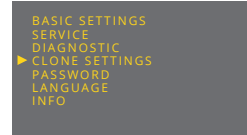

1. Press **OK** to enter the menu and select the item "CLONE SETTINGS". Copying of the settings from the body of the level meter to display module is done by selecting "SENSOR → DISPLAY MODULE". To transfer the settings from the display module to another level meter select the item DISPLAY MODULE → SENSOR.
2. The selected mode starts by pressing button **OK**. During transmission the display shows "NOW CLONING".
3. After completing the process in the middle of the screen displays "DONE". It is then possible to leave the menu and the mode by pressing the button **ESC**.



▶ **Incompatible type of level meter.** Transfer of the settings can be realized only with the same type of level meter.



▶ The data set **is not stored into the display module** (DM-70). The transfer can not be done. It is necessary to repeat the procedure of the copying the settings ("SENSOR → DISPLAY MODULE").

PASSWORD

You can **lock** the level meter data against **unauthorized editing**. After activating the password the data may be read, but can not be edited. If you try to edit the settings (without true password) the display shows "NO PASSWORD".

The password can be any 5-digit numeric combination. The combination of numbers 00000 is reserved for **disabling the password**.

1. Use the buttons **OK** and **↓** in the menu "PASSWORD" to select the mode "ENTER" for entering the password or the mode "CHANGE" for changing the password (when activated, the words are displayed inversely). Press the button **OK** once again to confirm the selection. You can change the password only when the level meter is unlocked. Otherwise, the words "NO PASSWORD" will be displayed.

- Now you can edit the password. The actual edited item is displayed inversely. Press the button **OK** to move to the next position (clockwise direction), button **↻** serves to change the values (0 ... 9).
- After the operation is completed, confirm the edited data by pressing the button **OK**.

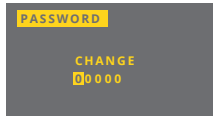
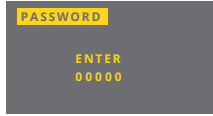
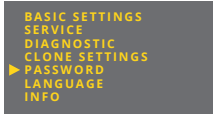

Display of status information to confirm data:

"YES" – correctly edited password

"NO" – incorrectly edited password

"OK" – the password saved (only in case of "CHANGE")

The password is automatically hidden after it is edited or changed ("00000" will appear).

To deactivate the password, edit the numerical combination "00000" in the mode "CHANGE".



The level meter with activated password will be automatically locked after 5 minutes of inactivity or after 5 min. from switching to measuring mode. Locking of level meter is indicated in the lower left corner of the screen by the letter "L".



If the password is lost, contact the manufacturer.

LANGUAGE

Setting the language of display menu.

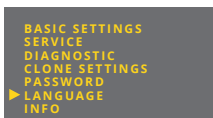

You can set five kinds of language:

ČESKY – ENGLISH – DEUTCH – POLSKI
– русский

INFO

Information about the type, serial number and production date of the level meter (type, serial number – SN and firmware version – SW).

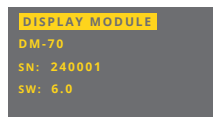
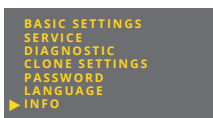

10. PROTOCOL HART®

Universal communication for data communication of peripheral devices with the level meter. Data transmission runs through the same line as the $4 \div 20\text{mA}$ current loop without impact on analog communication. For setting the level meter and collection of measured data, it is necessary to have available a HART communicator, by which it is possible to communicate directly with the level meter, or using it, to mediate communication with a peripheral device, see image 16.

ARLM-70

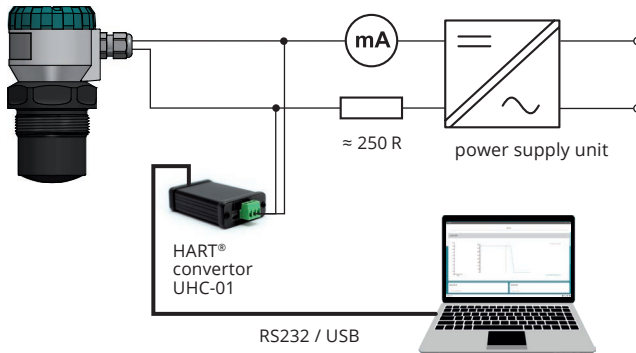

Obr. 16: Typical hardware configuration with HART

Revision

The implemented HART protocol revision is No. 5

| UNIVERSAL COMMANDS | |
|--------------------|--|
| 0 | Read unique identifier |
| 1 | Read primary variable |
| 2 | Read current and percent of range |
| 3 | Read current and four (predefined) dynamic variables |
| 6 | Write polling address |
| 11 | Read unique identifier associated with tag |
| 12 | Read message |
| 13 | Read tag, descriptor, date |
| 14 | Read PV sensor information |
| 15 | Read output information |
| 16 | Read final assembly number |
| 17 | Write message |
| 18 | Write tag, descriptor, date |
| 19 | Write final assembly number |

| STANDARD (PRACTICAL) COMMANDS | |
|-------------------------------|-------------------------------|
| 34 | Write damping value |
| 35 | Write range values |
| 40 | Enter/exit fixed current mode |
| 42 | Perform master reset |
| 44 | Write PV units |
| 49 | Write PV sensor serial number |

Meaning of variables

PV (primary variable) - distance to level

SV (secondary variable) - value shown on the display

TV (tertiary variable) - not used

QV (quaternary variable) - level height

11. FUNCTION AND STATUS INDICATION

Function and status indication are signalled by:

- display module (see chapter 8)
- setting the fault current to the value selected in MENU - SERVICE - FAILURE MODE (applies to the current version with HART® communication - I)
- status messages in HART® communication (valid for current version with HART® communication - I)

12. ORDER CODE

ORDER CODE

ARLM-70

PERFORMANCE

N basic design for non-explosive environments, aluminum body

MAXIMUM RANGE

20 0,3 ... 20m

PROCESS CONNECTION

G2 pipe thread G2"

OUTPUT TYPE

I 4-20mA current loop with HART communication

ELECTRICAL CONNECTION

B1 plastic cable gland M16

B2 plastic cable gland M20

H1 plastic cable gland for protective hose

SET-UP ELEMENTS

D version with OLED display (transparent lid)

C version with LCD display (transparent lid)

L without display (full lid without glass)

ARLM-70 N - 20 - G2 - I - B2 - D

EXAMPLE OF CODING

13. ACCESSORIES

| | | | |
|--------------------------------------|-----------------------|---------|---|
| 1x O-ring EPDM | included in the price | |  |
| universal convertor from USB to HART | at extra cost | UHC-01 |  |
| display unit | at extra cost | DM-70 |  |
| fixing nut plastic G2" | at extra cost | PUM-G2 |  |
| extension cable for display | at extra cost | PK-70-1 | |

14. SAFETY, PROTECTION, COMPATIBILITY AND EXPLOSION PROOF

The level meter is equipped with protection against reverse polarity, short-term overvoltage and current overload on output.

Protection against dangerous contact is provided by low safety voltage according to EN 33 2000-4-41 (SELV). EMC is ensured by conformity with standards EN 5501, EN 61326-1, EN 61000-4-2, EN 61000-4-3, EN 61000-4-4, EN 61000-4-5, EN 61000-4-6.

A declaration of conformity was issued for this device in the wording of Act No. 90/2016 Coll., as amended. The supplied electrical equipment meets the requirements of applicable government regulations on safety and electromagnetic compatibility.

15. USE, MANIPULATION AND MAINTENANCE

The level meter does not require any personnel for its operation. Follow-up displaying device is used to inform the technological entity operating personnel on the measured substance level height during the operation and in the location of the level meter display.

Maintenance of this equipment consists in verification of integrity of the level meter and of the supply cable. Depending on the character of the substance measured, we recommend to verify at least once per year the clarity of the front surface of the measuring level meter. In case any visible defects are discovered, the manufacturer or reseller of this equipment must be contacted immediately.



It is forbidden to perform any modifications or interventions into the ARLM-70 level meter without manufacturer's approval. Potential repairs must be carried out by the manufacturer or by a manufacturer authorized service organization only. Installation, commissioning, operation and maintenance of the ARLM-70 level meter has to be carried out in accordance with this instruction manual; the provisions of regulations in force regarding the installation of electrical equipment have to be adhered to.

16. GENERAL CONDITIONS AND WARRANTY

Dinel, s.r.o. guarantees for the period of three (3) years that the product has the characteristics as mentioned in the technical specification.

Dinel, s.r.o. is liable for defects ascertained within the warranty period and were claimed in writing.

This guarantee does not cover the damages resulting from misuse, improper installation or incorrect maintenance.

This guarantee ceases when the user or the other person makes any changes on the product or the product is mechanically or chemically damaged, or the serial number is not readable.

The warranty certificate must be presented to exercise a claim.

In the case of a rightful complaint, we will replace the product or its defective part. In both cases, the warranty period is extended by the period of repair.

17. MARKING OF LABELS

Labels for type of ARLM-70N-_-_-I-_-_:

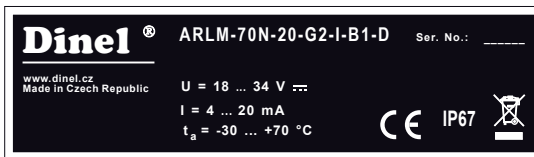

Example of label for type of ARLM-70N-20-G2-I-B1-D

Symbol of producer: logo Dinel®

Internet address: www.dinel.cz

Level meter type: ARLM-70N-_-_-I-_-_

Serial number: Ser. No.: xxxxx - (from the left: production year, serial production number)

Supply voltage: $U_i = 18 \dots 34 \text{ V} \sim$

Output current range: $I = 4 \div 20 \text{ mA}$

Ambient temperature range: $t_a = -30 \dots +70 \text{ °C}$

Protection class: IP67

Compliance mark: **CE**

Electro-waste take-back system mark:

18. TECHNICAL SPECIFICATIONS

| | | |
|--|---|--|
| Work environment | explosion-free area | |
| Supply voltage | 18 ... 34 V DC | |
| Output type | current 4 ... 20 mA with HART communication (limit values 3.9 - 20.5 mA) | |
| Current consumption | 4 ... 20 mA / max. 22 mA | |
| Basic measurement accuracy | 3 mm (see Fig. 17) | |
| Current output error ¹⁾ | max. 80 µA | |
| Resolution | 0,1 mm | |
| Maximum range | 20 m (see Fig. 17) | |
| Dead Zone ²⁾ | 30 cm (see Fig. 17) | |
| Adjustable measuring span (SPAN) | min. 200 mm | |
| Function principle | FMCW | |
| Operating temperature range | -30 ... +70 °C | |
| Max. operation overpressure | 2 bar | |
| Measuring frequency | 25 GHz (K-Band) | |
| Measurement sensitivity | 3 levels | |
| Damping | 1 ... 99 s | |
| Status signaling (echo dropout) | adjustable 3,75mA, 4mA, 20mA, 22mA, NO CHANGE | |
| The time of the first measurement from the start of the power supply | 20 s | |
| Separation capacity „power leads - housing“ | 2nF / 500 V AC | |
| Maximum load resistance at | U=24V U=22V U=20V | R = 270 Ω ³⁾ R = 180 Ω R = 90 Ω |
| Protection class | IP 67 | |
| Recommended cable | PVC 2x0,75 mm ² with a diameter of 6 ... 8 mm | |
| Tightening torque of the cable gland | 3 Nm | |
| Weight | cca 0,5 kg | |

¹⁾ This error only applies to the current output version. Data outputs (HART®, MODBUS®) are not affected by this error.

²⁾ Dead zone = Blind zone = Blocking distance

³⁾ Including HART 250Ω resistor

USED MATERIALS

| sensor part | variants | standard material |
|---------------------|--------------------------------|-------------------------------------|
| Lid | All types | aluminium alloy with powder coating |
| Glass | All types | polycarbonate |
| Body | All types | aluminium alloy with powder coating |
| Housing with thread | All types | plastic PP |
| Display module | ARLM-70_...-D,C (with display) | plastic POM |
| Cable gland | All types | plastic PA |

TECHNICAL SPECIFICATIONS – DISPLAY MODULE

| | | |
|--|-------------------------------|-----------------------------------|
| Display type | Matrix OLED, LCD ¹ | |
| Resolution | 128 x 64 pixel | |
| Character height / Number of digits measured value | 9 mm / 5 Digits | |
| Display colour | OLED | Yellow |
| | LCD | black with white background light |
| Buttons | Membrane switch panel | |
| Ambient temperature range | OLED | -30 ... +70 °C |
| | LCD | -20 ... +70 °C |
| Weight | 46 g | |

1) OLED- suitable for indoor and low-light applications. LCD – suitable for outdoor applications particularly with direct sunlight.

FACTORY DEFAULT

| | ARLM-70 _20 |
|-------------------------|-------------|
| MIN LEVEL ¹⁾ | 20 000 |
| MAX LEVEL ²⁾ | 300 |
| UNITS | mm; %; |
| DAMPING | 5 |
| SENSITIVITY | MEDIUM |
| FAILURE MODE – NO ECHO | 4.00 mA |
| POOLING ADDRESS (HART®) | 00 |
| PASSWORD | No password |

¹⁾Distance to min. level

²⁾Distance to max. level

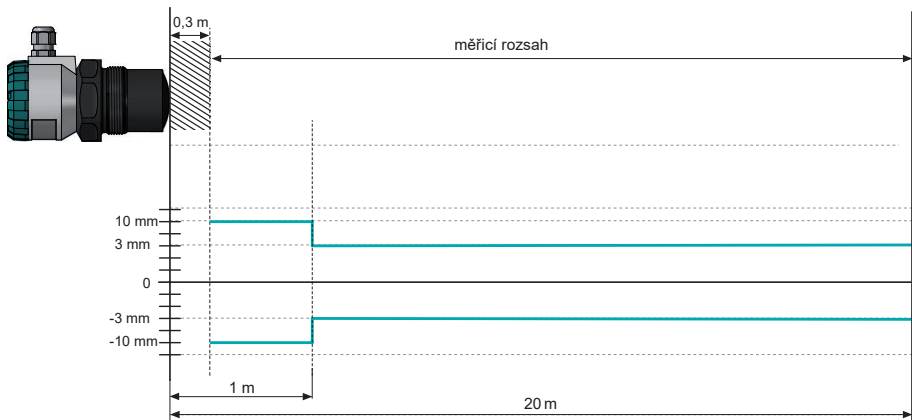

Fig. 17 Graph of dead zone and dependence of measurement error



- the hatched field indicates the dead zone ⁶⁾



- measurement deviation depending on the distance of the level from the sensor

19. PACKAGING, SHIPPING AND STORAGE

The device ARLM-70 is packaged in a polyethylene bag, and the entire consignment is placed into a cardboard box. A suitable filler material is used in the cardboard box to prevent mechanical damage during transport. Remove the device from the packaging only just before using, thereby protecting it from potential damage.

A forwarding company will be used to ship goods to the customer. Upon prior agreement, ordered goods can be picked up in person at company headquarters. When receiving, please check to see that the consignment is complete and matches the order, or to see if any damage has occurred to the packaging and device during transport. Do not use a device clearly damaged during transport, but rather contact the manufacturer in order to resolve the situation.

If the device is to be further shipped, it must be wrapped in its original packaging and protected against impact and weather conditions.

Store the device in its original packaging in dry areas covered from weather conditions, with humidity of up to 85 % without effects of chemically active substances. The storage temperature range is -10 °C to +50 °C.

Dinel[®]

industrial electronics

Dinel, s. r. o.
U Tescomy 249
760 01 Zlín
Czech Republic

phone: +420 577 002 003
e-mail: sale@dinel.cz

www.dinel.cz

applies to the firmware version:
level meter 1.0
display module 6.0 and higher

The manufacturer reserves the right to change the specifications and appearance of the product without prior notice

Find the updated version at www.dinel.cz

version: 01/2024 01/2024

