



CAPACITIVE LEVEL SENSORS DLS-27

CONTENT

1. Brief	6
2. Features of variants.....	6
3. Dimensional drawings	7
4. Mounting recommendation.....	8
5. Range of application.....	12
6. Electrical connection.....	13
7. Sensor setting.....	14
8. Status signalization.....	15
9. Accessories	16
10. Order code.....	17
11. Correct specification examples.....	17
12. Safety, protections, compatibility and explosion proof.....	18
13. Use, manipulation and maintenance	18
14. Marking of labels	19
15. Specifications	21
16. FAQ (Frequently asked questions).....	24

USED SYMBOLS

To ensure maximum safety of control processes, we have defined the following safety instructions and information. Each instruction is labeled with the appropriate pictogram.



Alert, warning, danger

This symbol informs you about particularly important instructions for installation and operation of equipment or dangerous situations that may occur during the installation and operation. Not observing these instructions may cause disturbance, damage or destruction of equipment or may cause injury.



Information

This symbol indicates particularly important characteristics of the device.



Note

This symbol indicates helpful additional information.

SAFETY



All operations described in this instruction manual have to be carried out by trained personnel or by an accredited person only. Installation, commissioning, operation and maintenance of the capacitive level sensors has to be carried out in accordance with this instruction manual; the provisions of regulations in force regarding the installation of electrical equipment have to be adhered to.

Improper use, installation or set-up of the sensor can lead to crashes in the application, (overfilling of the tank or damage of system components).

The manufacturer is not responsible for improper use, loss of work caused by either direct or indirect damage, and for expenses incurred at the time of installation or during the period of use of the level sensors.

PACKING, TRANSPORTATION AND STORAGE

Equipment DLS-27 is packed in a polythene bag and the whole consignment is placed in a cardboard box. The cardboard box is suitably filled to prevent mechanical damage during transport. Let the device packed up till the use to prevent possible damage.

Transport to the customer is realized by forwarding company. Upon receipt, please check whether the shipment is complete and corresponds to the extent of the order, or whether during the transport did not occurred the damage of the packaging or the equipment. The device apparently damaged during transport do not use and contact the manufacturer to resolve the situation.

If the device is transported further, then only wrapped in the original packaging and protected against shocks and weather. Store the device in its original packaging in a dry place, sheltered from the weather, with humidity up to 85% without the effects of chemically active substances. Storage temperature range is from -10 °C to +50 °C.



Sensor variants DLS-27, -20, 21, 22, 30 with the electrodes longer than 100 mm are fitted with protective caps at the ends of the electrodes to prevent damage of the electrodes, box rupture or injury of handling persons. Before commissioning, remove the caps.

1. BRIEF

Capacitive level sensors (switches) DLS® are designed for limit level sensing of liquids, bulky solid and powder materials in vessels, containers, silos, tanks, reservoirs, etc. Sensors are made in several modifications of sensing electrodes – short and long rods or rope. The electrodes can be coated what has important sense in case of adhesive, aggressive or electrically conductive media sensing. The process coupling at the housing can be with thread M27x2, M30x1.5, G3/4" or with Tri-clamp coupling. Electric connection is provided by means of permanent cable lead (variant B) or by means of connector (variant C). Output performances – transistor outputs with open collector (NPN, PNP) or NAMUR output.

There are next performances available: **N** – For normal atmospheres; **Xd** – For use in flammable dust atmospheres; **Xi** – Explosion proof – intrinsically safe for hazardous (explosive) areas and **XiM** – Explosion proof – intrinsically safe for use in mines with methane or flammable dust presence danger (see technical specifications). There are high temperature performance **NT**, **XiT**, **XiMT** available.

2. FEATURES OF VARIANTS

- | | |
|-------------------|--|
| DLS-27_-10 | Uncoated short bar electrode for sensing non-adhesive bulk-solid (powder) materials (sand, sugar) and electrically non-conductive liquids (oils, diesel, petrol), horizontal mounting. Electrode length 50 mm or 100 mm. |
| DLS-27_-11 | Fully coated short bar electrode (PTFE – Polytetrafluoroethylene) for sensing electrically conductive liquids (water). Assembly into a side wall of vessel or into a pipe. Electrode length 30 mm. |
| DLS-27_-20 | Semi-coated rod electrode (FEP – Tetrafluoroethylene-Perfluoro-Propylene) for sensing light-bulk solid or powder materials (plastic granulates, flour, cement) and non-conductive liquids (plant oils), horizontal, slant or vertical mounting. Electrode length from 0.1 m to 1 m. |
| DLS-27_-21 | Fully coated rod electrode (FEP) for sensing electrically conductive liquids (water solutions, water), adhesive and aggressive materials, horizontal or vertical mounting. Electrode length from 0.1 m to 1 m. |
| DLS-27_-22 | Fully coated rod electrode (PFA – Perfluoroalkoxy) for sensing electrically conductive liquids (water solutions, water), adhesive and aggressive materials, horizontal or vertical mounting. Electrode length from 0.1 m to 1 m. |
| DLS-27_-30 | Dismountable rod uncoated electrode for sensing bulk-solid (powder) materials and conductive or non-conductive liquids. Mounting from the top (vertically) or slant from the side. Electrode length from 0.1 m to 3 m. |
| DLS-27_-31 | Fully coated rod electrode for sensing aggressive electrically conductive liquids (water, solutions of chemicals), vertical mounting. Electrode length from 0.1 m to 2 m. |
| DLS-27_-40 | Uncoated stainless steel rope electrode and weight for general purpose in deeper silos (bulk-solid and powder materials sensing – sand, gravel, cement) or hoppers (liquids sensing), vertical mounting. Electrode length from 1 m to 6 m. |

3. DIMENSIONAL DRAWINGS

DLS-27_-10

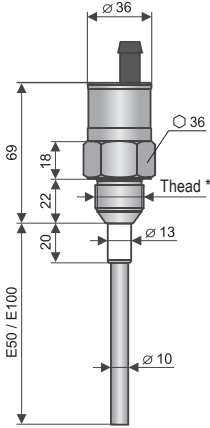

DLS-27_-11

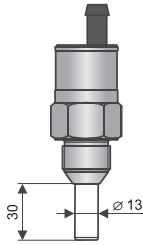

DLS-27_-20

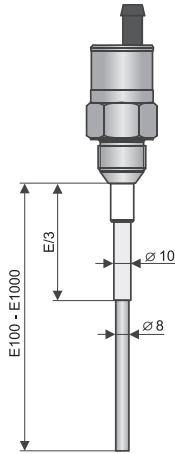

DLS-27_-21, 22

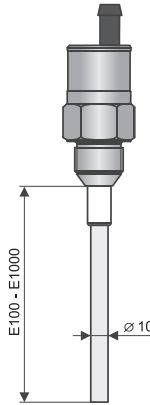

DLS-27_-30

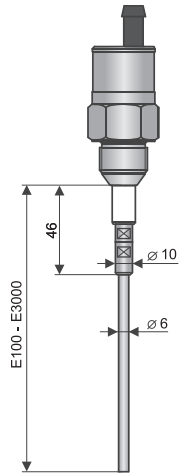

* Type of threads: G 3/4"
M27x2
M30x1,5

DLS-27_-31

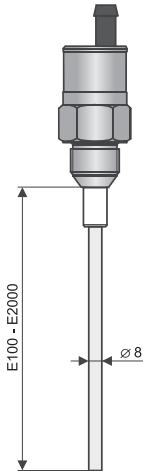

DLS-27_-40

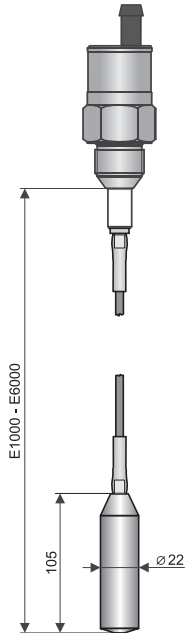

High temperatures variants

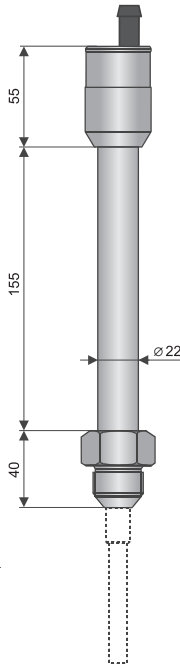

Tri-clamp process coupling

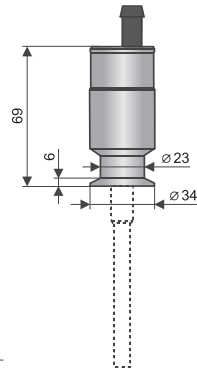

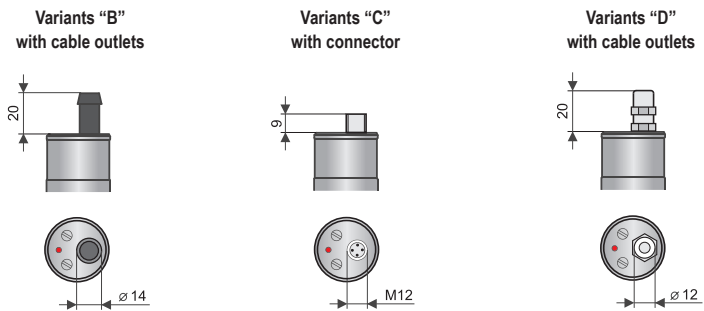

4. MOUNTING RECOMMENDATION

DLS level sensors can be fixed in a vertical, horizontal or bevelled position into the shell of the vessel, the storage tank for the fixation console in the pit, by screwing into the welding flange, using a fixing nut or TriClamp® process connection.

Basic application recommendations are mentioned below.



During assembly into the metal tank or the storage tank, it is not necessary to separately ground the base of the level sensor. In the case of installation in concrete tanks or silos, it is recommended to install a level sensor on the auxiliary metal construction (console, cap, etc.) and to then connect it using a permanently dipped metal item or with steel reinforcement in the concrete (armouring).

In the case of the reading of an aggressive medium, we recommend that the producer be consulted.



If the sensors are fitted with protective caps at the ends of the electrodes, remove the caps before commissioning.

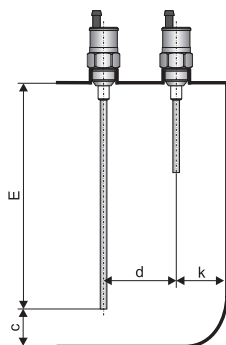

In the case of **vertical mounting** it is recommended to keep the mentioned distances applied to the length of the electrode (the longer one).

All vertically mounted sensors

$$c \geq 10 + \frac{E}{50} \qquad d \geq 40 + \frac{E}{40} \qquad k \geq 20 + \frac{E}{20}$$

E – Electrode length in mm

Fig. 1: Vertical mounting

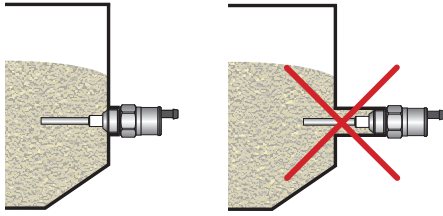

Fig. 2: Long fitting tubes in side wall mounting

In the case of **side wall mounting** it is necessary to avoid long fitting tubes, where could the rests of sensed media cumulate – see the right figure. We recommend to mount the sensor so that the whole sensing electrode is inside the container (vessel).

All from side mounted sensor

In the case of **side wall mounting** it is necessary to place the sensor aside the falling material (liquid or solid).

All from side mounted sensors

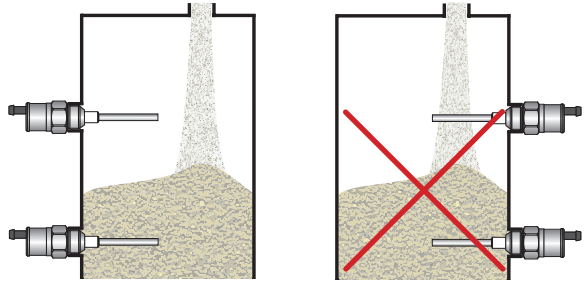

Fig. 3: Side wall mounting

Protective roof mounting is recommended when vertical movement of material could damage the sensing electrode (abrasive materials, blocks creating solid materials, etc.)

For DLS-27_-10 and DLS-27_-20

$$s \approx \frac{4}{3}E \quad p \approx \frac{3}{4}E \quad m \approx \frac{2}{3}E$$

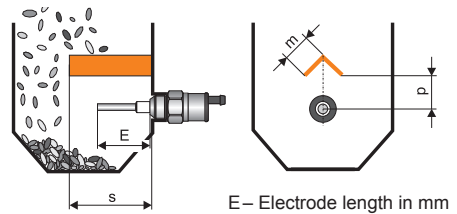

Fig. 4: Protective roof mounting

In the case of **slant wall mounting** it is necessary to eliminate long fittings and reduce the media sedimentation. The wrong example is in the middle figure. Left figure – appropriate mounting on the auxiliary vertical plate. In some cases is allowed the variant shown on the right figure – but only for DLS-27_-10 type, and only for not blocking materials.

For DLS-27_-10 and DLS-27_-20

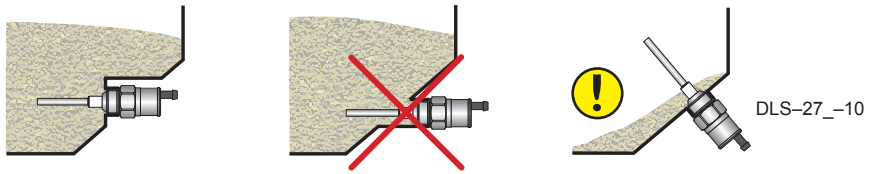

Fig. 5: Slant wall mounting

In the case of the application of the sensor in an **electrically non-conductive** (e.g. plastic) vessel in the vertical position, then for the correct function, it is recommended to connect the housing of the level sensor with an **auxiliary electrode**. The auxiliary electrode can consist of a bar which is permanently dipped into the medium (e.g. conductive probe CNP-18), or can be use the auxiliary plate electrode (PDE-27), where the first part has thread for install of the sensor and the second part is installed from the side on the wall into the area for the expected switching of the level sensor. Both parts of PDE-27 are connected by steel wire. The area of the plate auxiliary electrode is a minimum 200 cm². For non-conductive liquids, the only variation possible is with the plate auxiliary electrode and in this case it is necessary to place the level sensor to prevent the movement of electrodes and the axis is at the distance of $l_{max} = E1/10$, $l_{min} = 20$ mm.

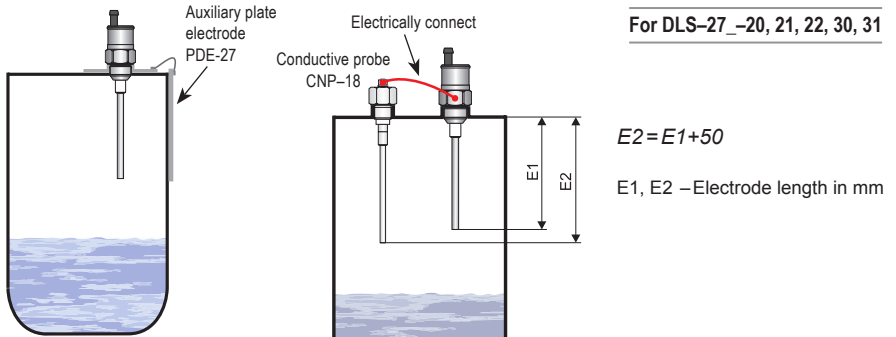

Fig. 6: Auxiliary electrode in non-conductive tanks

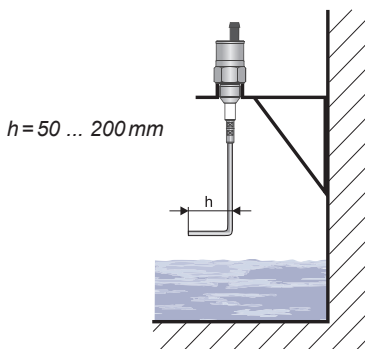

Fig. 7: Vertical installation for non-conductive fluids

When the environmental conditions (wind, rain, snow) are present, we recommend to use types with insulated electrode (21 or 31).

In the case of **vertical installation** for level sensing of **unknown liquid (conductive and non-conductive)** in tanks or sumps is useful to bend the end of electrode to right angle. The bend the end of electrode increases locally sensitivity and accuracy of level sensing.

For DLS-27_30

Mounting in a **bypass measuring tube**. We recommend to keep the tube diameter.

For: DLS-27_-20, 21, 22, 30, 31

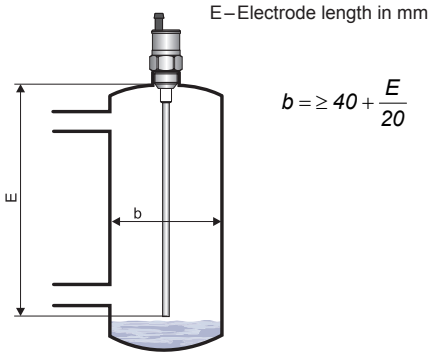

Fig. 8: Bypass measuring tube

In the case of **mounting in the pipe** it is necessary to provide the minimum distance of the inner walls from the electrode at 5 mm. In some cases (sticky fluids, low permittivity liquids) it is better to mount the sensor to pipe bend.

For DLS-27_-10, 11, 21, 22

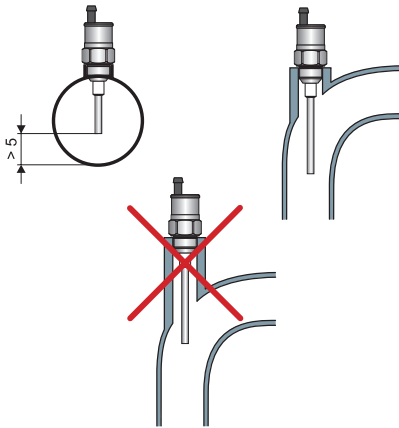

Fig. 10: Mounting in the pipe

In the case of vertical mounting in outer areas or in the case of high mechanical exertion we recommend to install **protective hose** on the cable.

All sensors with cable outlets

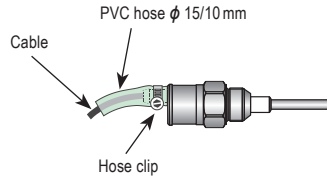

Fig. 9: Protective hose install

In the case of vertical mounting it is possible to use **hysteresis setting** for simple two state regulation (pump control). The height of the controlled level is done by sensitivity setting, the gap between the min. and max. is defined by hysteresis.

For DLS-27_-20, 21, 22, 30, 31

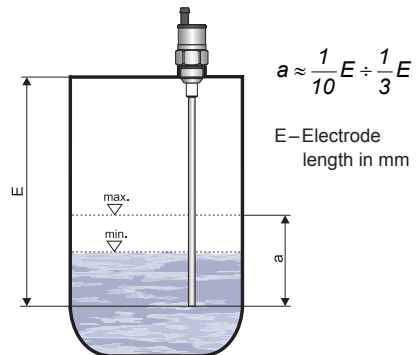

Fig. 11: Two state regulation by hysteresis setting

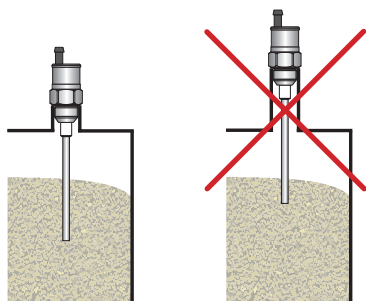

Fig. 12: Long fitting tubes in vertical mounting

In the case of vertical mounting it is necessary to avoid **long fitting tubes**, where could the vapours condense or some rests sediment. right figure – wrong, left figure – appropriate. The similar situation is when the sensing electrode goes through the concrete ceiling of the silo. The hole diameter should be at least 50 mm (acc. to the thickness of the ceiling).

All vertically mounted sensors

5. RANGE OF APPLICATION

DLS-27_-10

Is produced in two versions – with 50 mm or 100 mm length electrode. Short version (E50) is suitable for clean non-conductive liquids level sensing (oils, diesel, petrol, etc.). Longer version (E100) is designed for non-adhesive bulk-solid or non-adhesive powder materials (plastic granulates, sand, sugar, grains, etc.) and other non-conductive liquids (lubricants, plant oils). Sensor is specified to be mounted directly into a vessel or container wall (horizontal position) by means of welding flange or stainless steel fixing nut. In case of level sensing of low-permittivity media in non-conductive containers it is recommended to mount the sensor on auxiliary metal-plate electrode with min. 200 cm² area.

DLS-27_-11

Is specified for limit level sensing of electrically non-adhesive conductive liquids (water and water solutions). It is possible to use it for detection of boundary between different permittivity liquids (e.g. water – oil). Sensor is mounted directly into the side wall of the vessel or in a pipe (horizontal position) by means of normal or stainless steel welding flange.

DLS-27_-20

Is designed for limit level detection of light-bulk solid materials (plastic granulates) or powder materials (flour, cement, limestone powder, detergents, etc.) and for materials with variable humidity (feeding mixtures, wood sawdust, etc.). It is possible to use it for non-conductive fluids with up to 2% of water (plant oils, liquid propane, etc.). The sensor with electrode longer than 300 mm is recommended to mount in vertical position only. Sensor is mounted directly into a vessel or container wall in horizontal (up to E300), slant or vertical position by means of welding flange or stainless steel fixing nut. We should minimize the hollow spaces between the electrode and the wall where the material can sediment (see application notes). In case of level sensing in non-conductive containers it is recommended to mount the sensor on auxiliary metal plate electrode with min. 400 cm² area.

DLS-27_-21, 22

Is specified for conductive liquids level sensing (water, water solutions, mud, etc.). It is designed for horizontal (up to E300) or vertical installation directly in the wall of a vessel. It reacts on partial or full immersion of the electrode (dependent on adjusted sensitivity). The less is the sensitivity the better is resistance to an adhered rests of media. Sensor is mountable directly into wall of a vessel in horizontal or vertical position by means of welding flange.

DLS-27_-30

Is designed for universal use in vertical position for limit level detection of liquids (conductive and non-conductive) and bulk-solid and powder materials. It is not recommended to install the sensor into closed vessels where intensive condensation occurs. Electrically conductive liquids are sensed just by touch of the end of electrode. To react to non-conductive liquid or solid material it is necessary 5 ÷ 20% dip into a medium dependently on the permittivity of sensed medium and set sensitivity. Sensor is mounted directly into a tank, vessel, container or basin in slant or vertical position by means of welding flange or stainless steel fixing nut. In case of level sensing of low-permittivity media in non-conductive containers it is recommended to mount the sensor on auxiliary metal-plate electrode with min. 500 cm² area.

DLS-27_-31

Is designed for limit level detection of conductive liquids (water and solutions of chemicals). It is possible to install the sensor into closed vessels, tanks, basins, etc. The sensor reacts to liquid level after 2 ÷ 20% dip into a liquid dependently on the permittivity of sensed medium and set sensitivity. Sensor is mounted directly into a vessel, tank or open basins in vertical position by means of welding flange or fixing nut. When installed into an open basin it is necessary to ground the housing of sensor or to connect it with sensed liquid. For this purpose it is possible to use any metallic ever immersed object (pipe, etc.).

DLS-27_-40

Is specified for versatile use for limit level detection of liquids (conductive and non-conductive) and bulk-solid and powder materials in depths down to 6m. It is not recommended to install the sensor into closed vessels where intensive condensation occurs. Electrically conductive liquids are sensed just by touch of the end of electrode. To react to non-conductive liquid or solid material it is necessary 5 ÷ 20% immersion into a material. Sensor is mounted directly into a vessel, tank or open basins in vertical position by means of welding flange or fixing nut. When installed into an open basin it is necessary to ground the housing of sensor or to connect it with sensed liquid. For this purpose it is possible to use any metallic ever immersed object (pipe, etc.).

6. ELECTRICAL CONNECTION

Sensor with NPN or PNP output is allowed to lead only by resistive or inductive lead. Positive supply voltage (+U) is connected to the brown conductor BN (1), negative (0V) to the blue conductor BU (3) and the leads (only NPN or PNP type of output) to the black conductor BK (4). The capacity loads and low resistance loads (bulb) is evaluated by the sensor as short circuit.

Version Xd is manufacture only with fixing cable (variants "D" with cable outlets). The end of this cable must be in terminal box with protection class IP6x.

For "B" and "D" variants with the fixed cable, the individual colour cores of the connecting cable are connected to the respective terminals of the related equipment (supply unit) see Fig. 13 to 15.

For "C" variant with the connector, the cable can be supplied with the sensor (length 2 or 5 m), fitted with the pressed connector socket or dismountable connector socket without the cable (see accessories). In this case the cable is connected to the inside pins of the socket according to Fig. 16.

The sensor with related equipment is interconnected by a suitable three-core (N and Xd variations) or two-core (Xi, XiT, XiM, XiMT variations) cable. The length of the cable for the Xi, XiT, XiM, XiMT variations must be selected with respect to the maximum permitted parameters (usually inductance and capacity) of the outside intrinsically safe circuit of supply units (NSSU, NDSU, NLCU). If using a dismountable connector socket, the outside diameter of the cable is a maximum of 6 mm.



Electrical connection must be done in de-energized state! For switching supply sources, it is necessary to check that the input is galvanically separated from the network side and that they are fitted with a filter suppressing the conforming interference (terminals + and – oscillate together towards the ground potential), or the interference is removed in another manner.



It is recommended to lead the cable separately from power distribution leads and strong sources of EMI (pulse converters, electric motors etc.).

In case of strong ambient electromagnetic interference, paralleling of conductors with power distribution, or for the distribution to distance over 30 m, we recommend to use shielded cable.

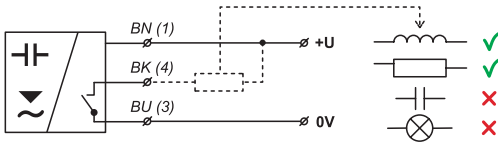

Fig. 13: NPN type sensors connection (version "N", "NT", "Xd")

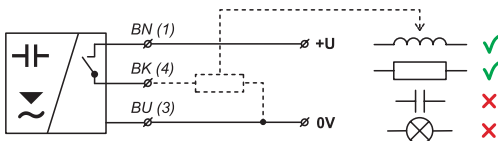

Fig. 14: PNP type sensors connection (version "N", "NT", "Xd")

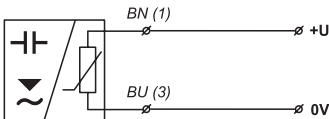

Fig. 15: NAMUR type sensors connection (version "Xi", "XiM", "XiT", "XiMT")

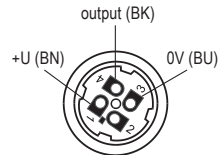

Fig. 16: Inside of the connector socket

Legend:

- (1, 3...) – Numbers of terminals inside of the connector socket
- BK – Black
- BN – Brown
- BU – Blue

7. SENSOR SETTING

The sensitivity and hysteresis of the level sensor are set by trimmers "S" and "H" located under the left cover screw on the rear side.

The basic sensitivity and hysteresis is factory adjusted and is suitable for most applications.

The sensitivity is set by trimmer "S" located under the left cover screw on the rear side. Clockwise turning makes the sensitivity lower, reverse direction turning makes the sensitivity higher.

If the sensed medium is at your disposal before setting into service it is useful to provide individual setting as follows. In this way it is possible to achieve resistance against sediments.

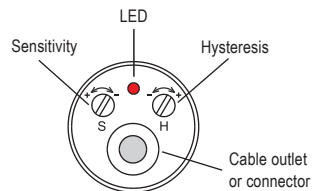

Fig. 17: Top view of level sensor

1. Activate the sensor by inundation (immersion) the electrode into the medium. With this activation, the sensor will change its status (LED lights ON or OFF).
2. Lower the sensitivity (by clockwise turning) until the sensors stop to react to this activation (dipping into medium). The LED is in the same status as before the activation.
3. Turn from ½ to 1 rotation left from the threshold point (when the sensor just stops its reaction to immersion). The sensor again changes the status and reacts again to the activation (flooding).
4. Check the setting.

If the medium is not available in advance, it is possible to use the basic setting from the producer and after some time of operation (after sedimentation of dirt) to make any correction. However, it is always necessary to know what the permittivity of the material is and to adapt the setting on the sensor. In the "Sensitivity characteristics" table it is stated for each type, where the change of capacity corresponds to the 1 rotation. A definite guide can be the fact that the flooding of the electrode in the length of 100 mm into the material with relative permeability $\epsilon_r = 2$ will cause a change in the capacity about 1.5 to 2 pF (according to the type of electrode).

The hysteresis (position of the minimum and maximum level) can be changed by turning trimmer "H" located under the right cover screw on the rear side. Clockwise turning makes the hysteresis higher, reverse direction turning makes it lower. The lower the hysteresis is, the higher sensitivity is possible to obtain, but the resistance against various disturbances get worse. For usual applications is optimal hysteresis from ¼ to ¾ rotation of sensitivity trimmer.

After setting, it is necessary to properly tighten cover screws.

SENSITIVITY CHARACTERISTICS

Type of sensor	Threshold sensitivity	Hysteresis	Sensitivity adjusting range	Temperature stability	Rel. permittivity of material
DLS-27_-10	0.1 pF	0.1 pF ... 2 pF	Min. 8 pF (1 rot. = 1 pF)	± 0.004 pF/K	Min. 1.4
DLS-27_-11	0.2 pF	0.2 pF ... 4 pF	Min. 20 pF (1 rot. = 2 pF)	± 0.007 pF/K	Min. 5.0
DLS-27_-20	0.1 pF	0.2 pF ... 3 pF	Min. 15 pF (1 rot. = 1.5 pF)	± 0.006 pF/K	Min. 1.3
DLS-27_-21	0.3 pF	0.3 pF ... 6 pF	Min. 30 pF (1 rot. = 3 pF)	± 0.01 pF/K	Min. 4.0
DLS-27_-22	0.3 pF	0.3 pF ... 6 pF	Min. 30 pF (1 rot. = 3 pF)	± 0.01 pF/K	Min. 4.0
DLS-27_-30	0.2 pF	0.2 pF ... 4 pF	Min. 20 pF (1 rot. = 2 pF)	± 0.01 pF/K	Min. 1.6
DLS-27_-31	0.3 pF	0.2 pF ... 5 pF	Min. 25 pF (1 rot. = 2.5 pF)	± 0.01 pF/K	Min. 5.0
DLS-27_-40	0.3 pF	0.2 pF ... 6 pF	Min. 20 pF (1 rot. = 2 pF)	± 0.01 pF/K	Min. 2.0

8. STATUS SIGNALIZATION

In the following table are the types of inputs and the respective statuses (ON/ OFF) in the case of a maximum and minimum level sensing. The signalling of the status of the sensor is indicated by the red LED located on the upper area of the sensor beside the setting trimmers of the hysteresis ("H") and the sensitivity ("S").



For minimum level sensing we recommend sensor with normally open output – NO, PO, RO. It is for failure safety reasons – eventual failure of sensor behaves similarly as an exceeding of the limit state. Analogically for maximum level sensing we recommend normally closed outputs – NC, PC, RC.

	Level state	Type of output	Output state	LED
Minimum level sensing		DLS-27N_ _ _ _ -NO_ _ DLS-27Xd_ _ _ -D-NO_ _ DLS-27N_ _ _ _ -PO_ _ DLS-27Xd_ _ _ -D-PO_ _	CLOSED	 (Shine)
		DLS-27Xi_ _ _ _ -RO_ _	HIGHER CURRENT	
		DLS-27N_ _ _ _ -NO_ _ DLS-27Xd_ _ _ -D-NO_ _ DLS-27N_ _ _ _ -PO_ _ DLS-27Xd_ _ _ -D-PO_ _	OPEN	 (Dark)
		DLS-27Xi_ _ _ _ -RO_ _	LOWER CURRENT	
Maximum level sensing		DLS-27N_ _ _ _ -NC_ _ DLS-27Xd_ _ _ -D-NC_ _ DLS-27N_ _ _ _ -PC_ _ DLS-27Xd_ _ _ -D-PC_ _	CLOSED	 (Shine)
		DLS-27Xi_ _ _ _ -RC_ _	HIGHER CURRENT	
		DLS-27N_ _ _ _ -NC_ _ DLS-27Xd_ _ _ -D-NC_ _ DLS-27N_ _ _ _ -PC_ _ DLS-27Xd_ _ _ -D-PC_ _	OPEN	 (Dark)
		DLS-27Xi_ _ _ _ -RC_ _	LOWER CURRENT	

9. ACCESSORIES

Standard

(included in the level sensors price)

- 1 pcs. Seal (asbestos free)
- 1 pcs. Screwdriver for adjustment (each 5 pcs.)

Optional

(for extra charge)

- Extra cables (over the standard length 2m)
- Connector socket (type ELWIKa or ELKA)
- Normal steel welding flange ON-27x2
- Stainless steel welding flange NN-G3/4"
- Stainless steel fixing nut UM-27x2
- Other seals (PTFE, Al, etc.)
- Auxiliary plate electrode PDE-27

10. ORDER CODE

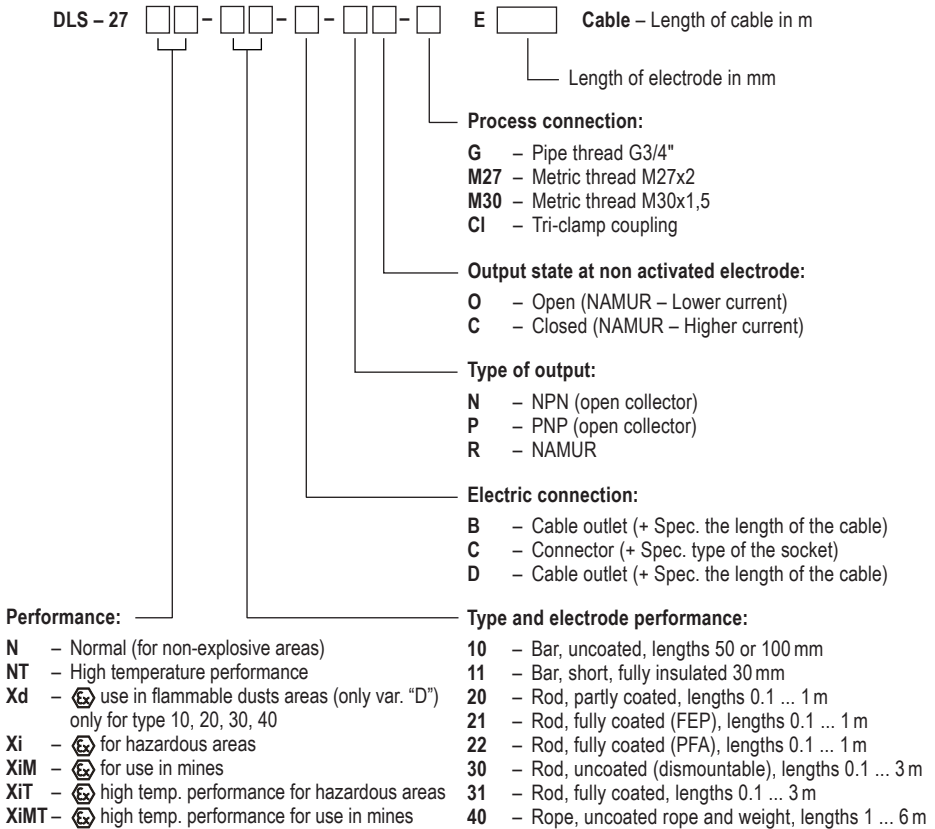

11. CORRECT SPECIFICATION EXAMPLES

DLS–27N–10–B–NO–M27 E100 cable 5 m

(N) Normal performance; (10) Uncoated bar electrode, (B) Cable outlet with 5 m length cable; (NO) Output type NPN with open state at non-activated electrode; (M27) Metric thread M27x2 process connection; (E100) Electrode length 100 mm

DLS–27NT–21–C–PC–G E580

(NT) High temperature performance; (21) Fully coated rod electrode (FEP); (C) Connector; (PC) Output type NPN with closed state at non-activated electrode; (G) Pipe thread G3/4" process connection; (E580) Electrode length 580 mm.

DLS–27Xi–30–C–RO–M30 E1420

(Xi) Explosion-proof performance; (30) Dismountable uncoated electrode; (C) Connector; (RO) Output type NAMUR with lower current at non-activated electrode; (M30) Metric thread M30x1.5 process connection; (E1420) Electrode length 1420 mm.

DLS–27Xd–20–D–NC–G E430 cable 3 m

(Xd) Flammable dust areas performance; (20) Partly coated electrode; (D) Cable outlet; (NC) Output type PNP with closed state at non-activated electrode; (M30) Metric thread M30x1,5 process connection; (E430) Electrode length 430 mm.

12. SAFETY, PROTECTIONS, COMPATIBILITY AND EXPLOSION PROOF

Level sensor DLS–27 is equipped with protection against electric shock on electrode, reverse polarity, output current overload, short circuit and short time over voltages.

Electromagnetic compatibility is provided by conformity with standards EN 55022/B, EN 61326-1, EN 61000-4-2, -3, -4, -5 and -6.

Explosion proof (DLS–27Xi, XiM and Xd) is provided by conformity with standards EN 60079-0, EN 60079-11, EN 60079-26 and is examined by FTZÚ – AO210 Ostrava – Radvanice, certificate No. FTZÚ 02 ATEX 0234X.

Explosion proof (DLS–27Xd) is provided by conformity with standards EN 60079-0, EN 60079-31 and is examined by FTZÚ – AO210 Ostrava – Radvanice, certificate No. FTZÚ 10 ATEX 0092X.

Supplied electrical equipment matches the requirements of valid European directives for safety and electromagnetic compatibility. The declaration of Conformity for the above mentioned product was issued.

Special conditions for safe use of variants DLS-27Xi (XiT, XiM, XiMT)

If the apparatus is used as device of Group II and with using of an approved power supply device, which output parameters comply with required input parameters, it is necessary to have an galvanic separation or in case of apparatus without galvanic separation (Zener barriers) it is necessary to provide equipotential equalizing between sensor and barrier earthing point.

If the apparatus is used in coal mine as device of Group I and with using of an approved power supply device, which output parameters comply with required input parameters it is necessary to have an galvanic separation.

When used in zone 0 the present explosive atmosphere of air mixture and gases, vapours of mists must be comply with: $20^{\circ}\text{C} \leq T_{\text{amb}} \leq 60^{\circ}\text{C}$, $0.8 \text{ bar} \leq p \leq 1.1 \text{ bar}$.

Design DLS–27Xi can be used in zone 0 or zone 20. With design DLS–27XiT can be used in zone 0 and zone 20 only electrode part head with electronics can be used only in zone 1 or zone 21.

Ambient temperature: $T_{\text{amb}} = -20^{\circ}\text{C}$ to $+75^{\circ}\text{C}$

Temperature of measured medium according to design variant see chapter “Specification”.

For design DLS–27XiMT it is necessary to observe that temperature of any surface of apparatus, when coal dust can from a layer, do not exceed 150°C .

Special conditions for safe use of variant DLS-27Xd

The sensor DLS-27Xd is designed with permanent cable. The cable must be terminated in connection box with degree of protection IP 6X.

13. USE, MANIPULATION AND MAINTENANCE

The level meter does not require any personnel for its operation.



It is forbidden to make any changes or interventions to the DLS–27 sensor without the consent of the producer. Any repairs must only be carried out by the producer or authorized service organisations.

Assembly, installation, commissioning, service and maintenance of the DLS–27 level sensor must be carried out in accordance with this manual and the provisions of valid standards for the installation of electrical equipment must be complied with.

14. GENERAL CONDITIONS AND WARRANTY

Dinel, s.r.o. guarantees for the period of three (3) years that the product has the characteristic as in technical specification is mentioned.

The guarantee can be invoked only when the product is completed by original invoice and guarantee list.

This guarantee does not cover the damages resulting from misuse, improper installation or incorrect maintenance.

This guarantee ceases when user or the other person makes any changes on the product or the product is mechanically or chemically damaged, or the serial number is not readable.

In the case of rightful complaint we replace the product or its defective part.

15. MARKING OF LABELS

Level sensors label data **DLS-27Xi** and **DLS-27XiT**

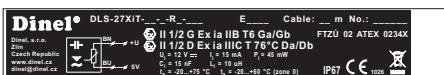
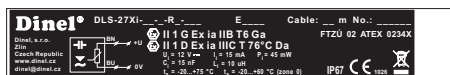

Symbol of producer: Dinel logo®

Internet and email address: www.dinel.cz, dinel@dinel.cz

Level sensor type and electrode length: DLS-27Xi (XiT)-__-R-__ Exxxx

Cable length in meters: Cable

Serial number: Ser. No.: xxxxx – (from the left: production year, serial production No.)

Electrical connection, wire colours

Label of non-explosive device:

Performance (Xi): II 1 G Ex ia IIB T6 Ga; II 1 D Ex ia IIIC T76°C Da

or performance (XiT): II 1/2 G Ex ia IIB T6 Ga/Gb; II 1/2 D Ex ia IIIC T76°C Da/Db

Limit operating parameters: $U_i = 12\text{ V}$, $I_i = 15\text{ mA}$; $P_i = 45\text{ mW}$; $C_i = 15\text{ nF}$; $L_i = 10\text{ }\mu\text{H}$

Ambient temperature range for the zone 0: $t_a = -20 \dots +60\text{ }^\circ\text{C}$

Ambient temperature range: $t_a = -20 \dots +75\text{ }^\circ\text{C}$

Number of certificate of intrinsically safety: FTZÚ 02 ATEX 0234X

Compliance mark: **CE**

Number of authorized person examining control of system quality: 1026

Protection class: IP67, Electro-waste take-back system mark:

Level sensors label data DLS-27Xd

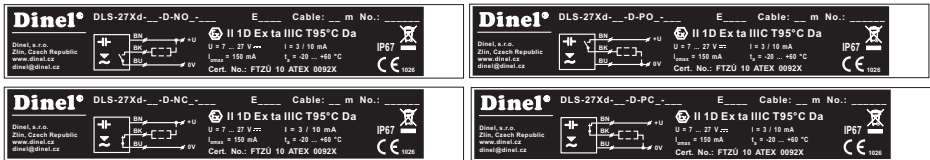

Symbol of producer: Dinel logo®

Internet and email address: www.dinel.cz, dinel@dinel.cz

Level sensor type and electrode length: DLS-27Xd-__-__-__ Exxxx

Cable length in meters: Cable

Serial number: Ser. No.: xxxxx – (from the left: production year, serial production No.)

Electrical connection, wire colours

Label of non-explosive device: Performance: II 1D Ex ia IIC T95°C Da

Supply voltage: U = 7 ... 27 V =

Current supply: I = 3 / 7 mA

Switching current: I_{max} = 150 mA

Ambient temperature range: ta = -20 ... +60 °C

Number of certificate of intrinsic safety: FTZÚ 10 ATEX 0092X

Compliance mark: **CE**

Number of authorized person examining control of system quality: 1026

Protection class: IP67, Electro-waste take-back system mark:

Level sensors label data DLS-27XiM and DLS-27XiMT



Symbol of producer: Dinel logo®

Internet and email address: www.dinel.cz, dinel@dinel.cz

Level sensor type and electrode length: DLS-27XiM (XiMT)-__-__-__ Exxxx

Cable length in meters: Cable

Serial number: Ser. No.: xxxxx – (from the left: production year, serial production No.)

Electrical connection, wire colours

Label of non-explosive device: Performance: I M2 Ex ia I Mb

Limit operating parameters: U_i = 12 V =, I_i = 15 mA; P_i = 45 mW; C_i = 15 nF; L_i = 10 µH

Ambient temperature range for the zone 0: ta = -20 ... +60 °C

Ambient temperature range: ta = -20 ... +75 °C

Number of certificate of intrinsic safety: FTZÚ 02 ATEX 0234X

Compliance mark: **CE**

Number of authorized person examining control of system quality: 1026

Protection class: IP67, Electro-waste take-back system mark:



Real label size is 97 x 12 mm.

16. SPECIFICATIONS

TECHNICAL DATA		
Supply voltage	performance DLS-27N performance DLS-27Xd	7 ... 36 V DC 7 ... 27 V DC
Current supply (state OFF / ON)		3 / 10 mA *
Max. switching current (NPN, PNP output)	performance DLS-27N performance DLS-27Xd	200 mA 150 mA
Remanent voltage – ON state		Max. 1.5 V
Output time delay		0.2 s
Input resistance / Electric strength		1 MΩ / 1 kV AC
Coupling capacity / Electric strength		47 nF / 250 V AC *
Protection class		IP67
Cable (version with cable outlets)		PVC 3x0.5mm ² or 2x0.75mm ²
Weight (excl. electrode, cable 2 m)	DLS-27_ DLS-27_T	Approx. 0.4kg Approx. 0.7kg

* Only for variants "N" and "Xd"

ELECTRICAL PARAMETERS – variants Xi, XiT, XiM, XiMT	
Supply voltage	8 ... 9 V DC
Current supply (state OFF / ON) – NAMUR	≤ 1 mA / ≥ 2.2 mA
Max. internal values	Ui= 12VDC; Ii= 15mA; Pi= 45mW; Ci= 15nF; Li= 10μH
Coupling capacity / Electric strength	2.7 nF / 500 V AC
Cables LC values	Typ. C < 150 pF/m Typ. L < 0.8 μH /m

USED MATERIALS		
Part of the DLS	Type	Standard material *
Housing	All type	W.Nr. 1.4301 (AISI 304)
Insulating bushing	All type	Teflon® PTFE (Polytetrafluoroethylene)
Electrode	DLS-27_10,11,20,21,22,30,31 DLS-27_-40	W.Nr. 1.4301 (AISI 304) W. Nr. 1.4404 (AISI 316 L)
Electrode coating	DLS-27_-11	Teflon® PTFE (Polytetrafluoroethylene)
Electrode coating	DLS-27N(Xi)-20, 21, 31	Teflon® FEP (Fluorinated ethylene propylene)
Electrode coating	DLS-27Xd-20	Electrostatically conductive PTFE Ex
Electrode coating	DLS-27_-22	Teflon® PFA (Perfluoroalkoxy)
Weight	DLS-27_-40	W.Nr. 1.4301 (AISI 304)

* On request can be selected other type of material.

WORKING AREAS (EN 60079-10, 14 and EN 50281-1-2)

DLS-27N	Performance for non-explosive areas.
DLS-27NT	High temperature performance for non-explosive areas.
DLS-27Xd	Performance for flammable dust areas, Ⓜ II 1D Ex ia IIIC T95°C Da, whole sensor zone 20, 21 and 22. Only for type 10, 20, 30, 40. The type 20 has electrode coating from electrostatically conductive PTFE Ex.
DLS-27Xi	Performance for explosive areas, Ⓜ II 1 G Ex ia IIB T6 Ga; Ⓜ II 1 D Ex ia IIIC T76°C Da with intrinsically safe supply units, whole sensor zone 0 and 20.
DLS-27XiT	High temperature performance for explosive areas, Ⓜ II 1/2 G Ex ia IIB T6 Ga/Gb; Ⓜ II 1/2 D Ex ia IIIC T76°C Da/Db with intrinsically safe supply units, electrode part zone 0 and 20, housing zone 1 and 21.
DLS-27XiM	Intrinsically safe explosion-proof performance for use in mines, Ⓜ I M2 Ex ia I Mb with intrinsically safe supply units.
DLS-27XiMT	High temperature intrinsically safe explosion-proof performance for use in mines, Ⓜ I M2 Ex ia I Mb with intrinsically safe supply units.

TYPE OF OUTPUT

Output	Variants
NPN ("NC", "NO")	N, NT, Xd
PNP ("PC", "PO")	N, NT, Xd
NAMUR ("RC", "RO")	Xi, XiM, XiT, XiMT

PROCESS CONNECTION

Type	Size	Marking
Pipe thread	G3/4"	G
Metric thread	M27x2	M27
Metric thread	M30x1.5	M30
Tri-clamp (standards DN 20)	–	CI

TEMPERATURE AND PRESSURE DURABILITY

Variant / Performance	Mounting	Temp. t_p	Temp. t_m	Temp. t_a	Max. operating pressure for temperature t_p					
					to 30 °C	to 85 °C	to 120 °C	to 150 °C	to 180 °C	
DLS-27N-10, 11, 20, 30	Horizontal	-25 ... +85 °C	-25 ... +85 °C	-20 ... +80 °C	3 MPa	2 MPa	-	-	-	
DLS-27N-20, 21, 22, 30, 31, 40	Vertical	-25 ... +85 °C	-40 ... +150 °C	-20 ... +80 °C	3 MPa	2 MPa	-	-	-	
DLS-27NT-10, 11, 20, 30	Any	-40 ... +200 °C	-40 ... +200 °C	-20 ... +75 °C	3 MPa	2 MPa	0.5 MPa	0.3 MPa	0.1 MPa	
DLS-27NT-21, 22, 31, 40	Any	-40 ... +180 °C	-40 ... +180 °C	-20 ... +75 °C	3 MPa	2 MPa	0.5 MPa	0.3 MPa	0.1 MPa	
DLS-27Xd	Any	-20 ... +60 °C	-20 ... +60 °C	-20 ... +60 °C	3 MPa	2 MPa	-	-	-	
DLS-27Xi, XIM	Any	-20 ... +85 °C	-20 ... +85 °C	-20 ... +75 °C	-	-	-	-	-	
DLS-27XIT, XIMT-10, 11, 20, 30	Any	-40 ... +200 °C	-30 ... +200 °C	-20 ... +75 °C	3 MPa	2 MPa	0.5 MPa	0.3 MPa	0.1 MPa	
DLS-27XIT, XIMT-21, 22, 31, 40	Vertical	-40 ... +180 °C	-30 ... +120 °C	-20 ... +75 °C	3 MPa	2 MPa	0.5 MPa	0.3 MPa	0.1 MPa	
DLS-27Xi, XIT, XIM, XIMT – zone 0	Any	-20 ... +60 °C	-20 ... +60 °C	-20 ... +60 °C	0.08 ... 0.11 MPa	to 30 °C				
DLS-27XIM, XIMT – mine application Mb	Any	Max. 150 °C any surface where the coal-dust may consist layers								

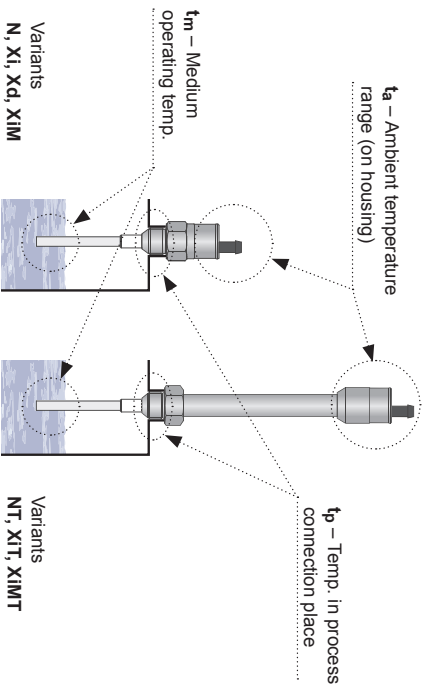

17. FAQ (FREQUENTLY ASKED QUESTIONS)

Question	Answer / Solution
<p>The sensor does not have sharp switching, the connected relay grumbles.</p>	<p>Did you use the correct supply? It is necessary to use the source of DC smoothing voltage (not only rectified pulsing voltage), the best supply unit is Dinel or another suitable stabilized source.</p>
<p>The sensor does not have sharp switching, the connected relay during the transfer from one status to the other status grumbles despite the fact that the supply is OK.</p>	<p>Is the hysteresis set on the sensor correctly? It will be necessary to increase the hysteresis by trimmer "H" (by turning in a clockwise direction).</p>
<p>After the connection of the correct supply, the sensor does not switch the load.</p>	<p>Did you select and connect the load correctly? Does the load have the character of the bulb (very small resistance in inactive status) or does it not contain higher capacitors? With the output it is only possible to switch the resistance and inductive loads, see connection of sensors (Fig. 13, 14, 15). Type of output PNP – the load is connected between the output and zero potential. Type NPN – the load between the output and the positive field of the supply.</p>
<p>After activation (filling, flooding), the sensor does not switch..</p>	<p>Is the sensitivity of the sensor too high? The electronics of the sensor are evidently only activated by the case (head) and the electrode or remainders on the electrode. It is necessary to decrease the sensitivity by trimmer "S" (to turn in clockwise direction).</p>
<p>After connection of the supply, the sensor is disconnected and is switched by touching with the hand. Then, it will remain permanently switched. It is necessary to disconnect it from the source and connect it again.</p>	<p>The sensor is evidently set so that it has too large hysteresis and the change of the capacity after deactivation is insufficient for exceeding the area of hysteresis and re-disconnection. It is sufficient to decrease the hysteresis or to modify (decrease) the sensitivity so that the sensor is able to achieve both marginal statuses – connection and disconnection.</p>
<p>The sensor is disconnected from the side. After installation, the sensor responded to the conductive liquid several times, but then responses stopped and it remained in the activated status. The decrease of the sensitivity did not help.</p>	<p>This mainly concerns the liquid which is able to create a continuous, electrically conductive coat on the electrode (or the insulation). An example of such liquids are some lye and alkaline washing detergents, flushing water with metal content, etc. It is always necessary to test the function or to select the assembly from upwards.</p>
<p>Does the dust badly affect the function of DLS sensors?</p>	<p>No. The dust have almost no effect to function (as similar as dry non-conductive adhered rests of material). The state of sensor changes only when the mass of material covers the electrode. The different situation is when the insulating bushing is covered by mixture of condensed water and dust. These problems can be solved by type choice of sensor and right sensitivity setting</p>
<p>Does the DLS sensor react on foams on the level?</p>	<p>There exist various foams and capacitive sensors react on them differently. When the base of foam is electrically conductive solution (e.g. beer) we can DLS sensor use for foam detection, but it is possible to make them on foams insensitive (by means of type choice, sensitivity setting). The DLS sensors are generally insensitive on foams from non-conductive liquids (plant oils)</p>

Dinel[®]

industrial electronics

Dinel, s.r.o.
U Tescomy 249
760 01 Zlín
Czech Republic

Phone: +420 577 002 003

Fax: +420 577 002 007

E-mail: sale@dinel.cz

www.dinel.cz

The latest version of this instruction manual can be found at www.dinel.cz

Version: 11/2015



QMS
ISO 9001

