



ULTRASONIC LEVEL METERS ULM – 70

Firmware: v.2.0

TABLE OF CONTENTS

| | |
|---|----|
| 1. Measuring principle | 3 |
| 2. Range of applications | 3 |
| 3. Variants of sensors | 3 |
| 4. Dimensional drawings | 4 |
| 5. Installation and putting into operation | 4 |
| 6. Installation instructions | 5 |
| 7. Electrical connection | 9 |
| 8. Examples of ULM-70 connection | 10 |
| 8.1. Wiring diagram of the level meter with current output and PDU unit..... | 10 |
| 8.2. Wiring diagram of the level meter with current output and PDU unit in versions for explosive areas..... | 11 |
| 8.3. Wiring diagram of the level meter with current output and MGU unit..... | 13 |
| 8.4. Wiring diagram of the level meter with Modbus / RS485 and MGU unit..... | 13 |
| 8.5. Wiring diagram of the level meter with Modbus / RS485 and PDU unit..... | 13 |
| 9. Set-up elements | 14 |
| 10. Status signalization | 14 |
| 11. Operation and setting | 15 |
| 10.1. Basic configuration..... | 15 |
| 10.2. Service settings..... | 18 |
| 10.3. Additional functions..... | 20 |
| 12. HART® communication protocol | 22 |
| 13. Modbus® communication protocol | 23 |
| 14. Order code | 23 |
| 15. Accessories | 23 |
| 16. Safety, protection, compatibility and explosion proof | 24 |
| 17. Use, manipulation and maintenance | 24 |
| 18. Marking of labels | 25 |
| 19. Menu structure | 27 |
| 20. Specifications | 28 |
| 21. Packing, shipping and storage | 30 |

SAFETY



All operations described in this instruction manual have to be carried out only by trained personnel or an accredited person. Warranty and post warranty service must be exclusively carried out by the manufacturer.

Improper use, installation or set-up of the level meter can result in crashes in the application (overflowing of the tank or damage of system components).

The manufacturer is not responsible for improper use, losses of work caused by either direct or indirect damage, and for expenses incurred during installation or use of the level meter.

1. MEASURING PRINCIPLE

Ultrasonic level meter ULM® is a compact measuring device consisting of two parts - main level meter (the body with measuring electronics) and display module. Using the electroacoustic converter, the level meters transmit the sequence of ultrasonic pulses that spread towards the surface level. The converter recuperates reflected acoustic waves that are subsequently processed in the electronic module. The intelligent evaluation block filters out interfering signals, compares the cleaned received signal with the false reflection map (e.g. from mixers, ladders, reinforcement etc.) and selects a suitable reflection (echo). Based on the period during which the individual pulses spread towards the surface level and back and based on the measured temperature in the tank, the instant distance to the surface level is calculated. According to the level height, the level meter output is set and the measured value is displayed on the display.

2. RANGE OF APPLICATIONS

For continuous non-contact level measurement of liquids (water solutions, sewerage water, etc.), mash and paste materials (sediments, sticks, resins etc.) in closed or open vessels, sumps, reservoirs and open channels. In case the level of bulk-solid materials is measured, the measurement range is reduced. The level meters can continuously measure levels of bulk-solid materials with a low concentration of dust particles. Consult the manufacturer on recommended use of the level meter for bulk-solid materials.

3. VARIANTS OF SENSORS

ULM-70_-02 **Measuring range from 0.15m to 2m**, plastic PVDF transmitter, mechanical connection with thread G 1".

ULM-70_-06 **Measuring range from 0.25m to 6m**, plastic PVDF transmitter, mechanical connection with thread G 1 ½".

ULM-70_-10 **Measuring range from 0.4m to 10m**, plastic PVDF transmitter, mechanical connection with thread G 2 ¼".

ULM-70_-20 **Measuring range from 0.5m to 20m**, plastic PVDF transmitter, mechanical connection with aluminium alloy flange.

4. DIMENSIONAL DRAWINGS

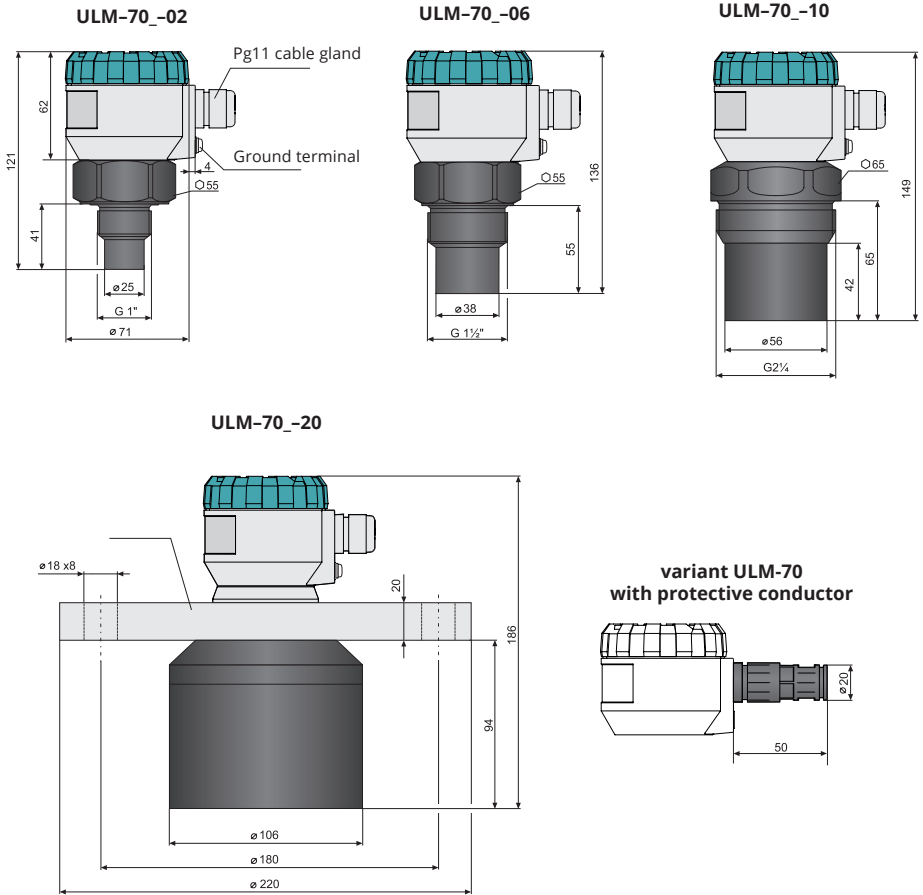

5. INSTALLATION AND PUTTING INTO OPERATION

This procedure includes the following three steps.

- **INSTALLATION**
- **ELECTRIC CONNECTION**
- **SETTING**

6. INSTALLATION INSTRUCTIONS

- Install the level meter in the **vertical position** into the upper lid of the tank or reservoir using a welding flange, a fastening nut or a flange so that the level meter axis can be perpendicular to the surface level of the measured liquid (Fig. 1).
- The min. **dimensional parameters** to install the level meter into a lid or a ceiling of a tank are given in Fig. 3.
- When installing in an **open channel** (reservoir, drain etc.), install the level meter onto a bracket as close as possible to the expected max. level.
- The reference plane for the measurement is the lower edge of the transducer (Fig.2). In connection with the measurement principle, no signals **reflected** in the area immediately under the level meter can be evaluated. **The zone** (Fig. 2) determines the min. distance possible between the level meter and the highest surface level. The min. distances to the medium are given in the chapter "Specifications".
- It is necessary to install the level meter so that the bin level cannot **interfere** with the dead zone when filled up to the maximum. If the measured level interferes with the dead zone, the level meter will not work properly.

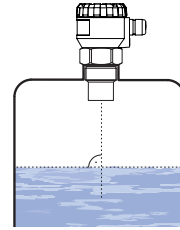

Fig. 1: Recommended installation in the tank

| | |
|---------------|-------------------------------|
| ULM-70-02; 10 | $d > 1/12 c$ (min. 200 mm) |
| ULM-70-06 | $d > 1/8 c$ (min. 200 mm) |
| ULM-70-20 | $d > 1/10 c$ (min. 200 mm) |

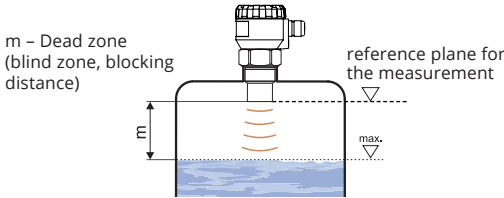

Fig. 2: Level meter dead zone

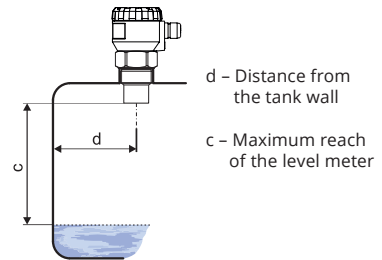

Fig. 3: Installation distance from the tank wall

- If the maximum surface level in the tank interferes with the dead zone, the level meter has to be mounted into a higher **installation neck**. In this way, the tank can be filled nearly up to the maximum volume. The inner neck surface has to be even and smooth (without edges and welded joints); the inner edge should be rounded where the ultrasonic wave leaves the pipe. The neck diameter should be as large as possible but the neck height should be as low as possible. Recommended dimensions of the input neck are given in Fig. 4.

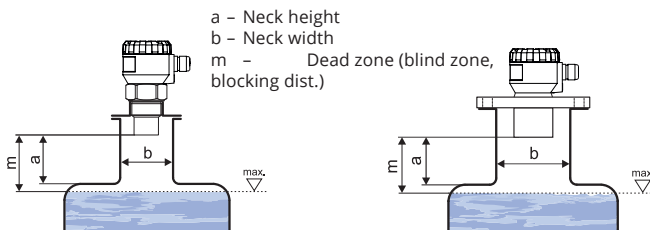

Fig. 4: Possible installation of the installation neck

| | |
|---------------|-------------------------------------|
| ULM-70-02; 06 | $a < 3 b$ $b > 100 \text{ mm}$ |
| ULM-70-10 | $a < 1,5 b$ $b > 100 \text{ mm}$ |
| ULM-70-20 | $a < 1,5 b$ $b > 150 \text{ mm}$ |

- If the emitted acoustic signal of the level meter is affected by near objects (roughness on walls of the tank, various partitions, mixers etc.), it is necessary to map false reflections by activating the mode "TEACHING". In case of installed mixers, it is necessary to put the mixers to position under the level meter (direct the mixer paddle to the ultrasonic signal beam) (Fig. 5 and 6).

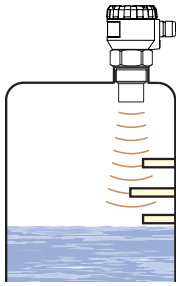

Fig. 5: False echo from obstacles in the tank

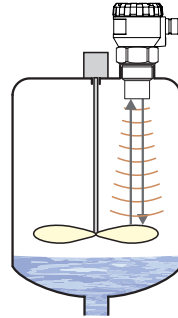

Fig. 6: False echo from the mixer paddle

- Do not install the level meter in or above the **filling** point (Fig. 7).

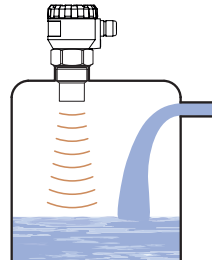
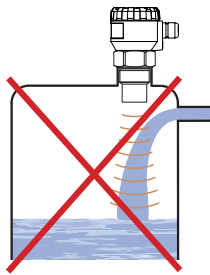

Fig. 7: Level meter installation outside the influence of filling

- In case the level of bulk solids is measured, the measurement range is reduced. Due to absorption of acoustic waves by a bulk medium, shortening of the measuring range occurs by up to 50% depending on the grain size. We therefore recommend selecting a level meter with greater range than the maximum range of measuring the medium. It is also appropriate to use a directional horn (see image 8), which reduces the shortening of the measuring range, because it better concentrates acoustic energy while preserving the same beam angle, and improves the sensitivity when receiving the reflected echo. We recommend to consult the use with the manufacturer.

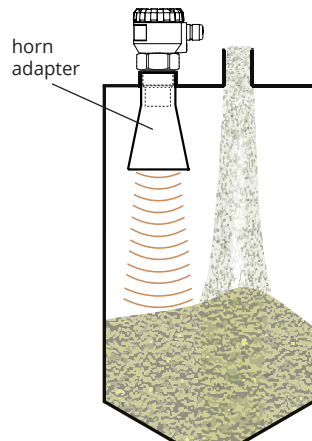

Fig. 8: Level meter installation in silo or hopper

- During filling, mixing and other processes, **foam** can arise on the surface level of the measured liquid. The foam considerably absorbs the ultrasonic signal which might cause malfunction of the level meter (Fig. 9). For such cases, it is necessary to set up "SENSITIVITY" mode to "high" or contact the manufacturer if need. In case of a thin layer of foam, it is also possible to use the directional horn for improving receipt of the reflected echo.

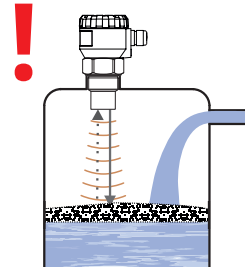

Fig. 9: Foam on the surface

- Scattering or attenuation of the ultrasonic signal can result if the surface level has been **moderately stirred or rippled** (by a mixer, coming liquid etc.). It can result in reduction of the measurement range or unreliable function of the level meter (Fig. 10).
- Rotating **mixer blades** can cause that the surface is stirred, which results in false reflections of the ultrasonic signal from the surface level and unreliable operation of the level meter (Fig. 13). **For a rippled or swirling level, you can use the directional horn to eliminate scattering of the ultrasonic signal.**

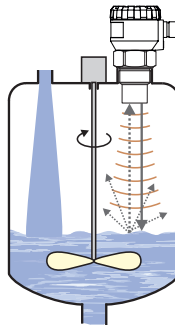

Fig. 10: Moderately stirred surface

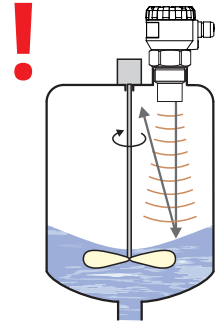

Fig. 11: Intensely stirred surface

- If the level sensor is mounted to bottlenecks and places with barriers, or near uneven walls or the filling area, where the transmission signal could be distorted, we recommend using a guide tube (acoustic horn). The tube must be made from a single material with a smooth inner surface (see image 12a, 12b). The minimum tube diameter must have the dimension "b" according to image 4 on page 5. After installing, you must perform the procedure "LEARNING". We recommend consulting with the manufacture on the construction of the guide tube.

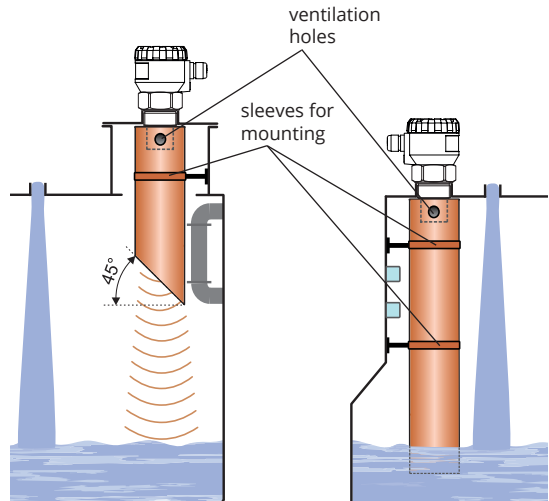

Fig. 12a: Short guide tube installation

Fig. 12b: Total guide tube installation

- The level meter must not be installed in places with direct **solar radiation** and must be protected against weather effects.
- If the installation in places with direct solar radiation is inevitable, it is necessary to mount a **shielding cover** above the level meter (Fig. 13).
- It is suitable to run the cable under a cable bushing (obliquely down in slack) according to Fig. 14 to prevent **penetration of humidity**. Then the rain and condensing water can flow off freely.
- The cable bushing and connector have to be **sufficiently tightened** to prevent penetration of humidity.
- To lower the minimum distance to the measured medium, **a reflection board** made from solid, even and smooth material can be installed to the level meter. Then the tank can be filled nearly up to the maximum height. The solution is suitable for open tanks and reservoirs (Fig. 15).

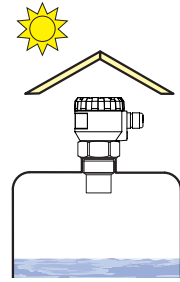

Fig. 13: Solar radiation shielding cover

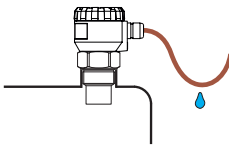

Fig. 14: Prevention to avoid intrusion of humidity

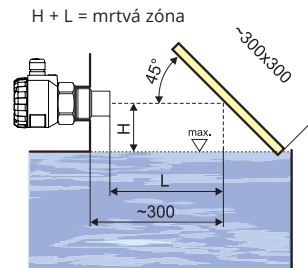

Fig. 15: Reflection board

7. ELECTRICAL CONNECTION

The level meter is connected to consequential (evaluating) device with a suitable cable with the outer diameter of 6 to 8 mm using screw terminals located under the display module. The recommended cross section of cores for the current version $2 \times 0,5 \div 0,75 \text{ mm}^2$ and for the version with Modbus communication $2 \times 2 \times 0,25 \text{ mm}^2$ (twisted pair, shielded). Plus pole (+U) is connected to the terminal (+), minus pole (0 V) to the terminal (-) and the shielding (only for shielded cables) to the terminal (\perp). Communication wires A and B of the line RS-485 (for version "M" - Modbus) are connected to the terminals A and B.

Procedure to connect the cable to the level meter:

1. Unscrew the nut of the upper transparent lid.
2. Take the upper edge of the display module and take it out carefully by mild swinging up.
3. If you cannot grasp the module, you can use a small screwdriver. Insert it as far as the seam and use from several sides to slightly lift the module.
4. Release the cable outlet and thread the stripped supply cable in.
5. Connect the cable to the screw terminals according to the diagram in Fig. 17 or 18. Firmly tighten the terminals and the cable outlet.
6. If the level meter with Modbus is involved as a terminal for RS-485, we recommend (to avoid reflections on the line) to connect 120Ω termination resistor. This is done by moving a small lever of the switch marked 120Ω to the ON position. On the level meters connected to the line RS-485 as an intermediate device, the termination resistors are not connected (switch remains off).
7. Insert the display module back into the head so that the connector is properly connected.
8. Slide silicone seal on the thread of the level meter body, then tighten the nut of the upper lid. Connect the cable to consequential device.

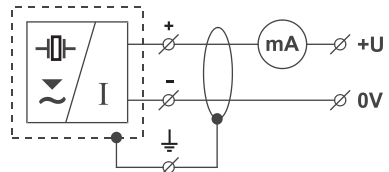

Fig. 16: Wiring diagram of the level meter with current output ULM-70_---I

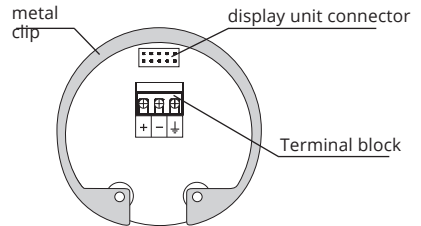

Fig. 17: Inside view of screw terminals of the level meter with current output ULM-70_---I

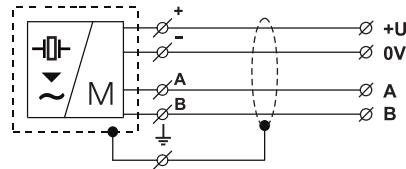

Fig. 18: Wiring diagram of the level meter with Modbus ULM-70_---M

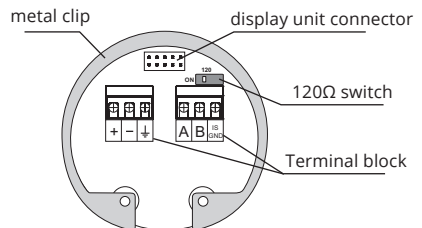

Fig. 19: Inside view of screw terminals of the level meter with Modbus ULM-70_---M



Electrical connection must be done in de-energized state!

With regard to possible occurrence of electrostatic charge on non-conductive parts of the level meter, all level meters for explosive spaces (ULM-70Xi type) must be grounded. It will be done using a screw placed on the head of the level meter under the cable outlet.



It is also necessary to design and take measures to reduce the effects of static electricity to a safe level in the wiring.

Installation in explosive atmospheres needs to be carried out in compliance with CSN EN 60079-14 (Electrical installations for explosive gaseous atmospheres – Part 14: Electrical installations in dangerous areas other than mining) and possibly also in compliance with other standards relating to the area concerned.



The supply voltage source should be preferably realized as a stabilized power supply unit with safe voltage from 18 to 36 V DC (18 ÷ 30 V DC for Xi version), which can be a part of the evaluation or display device.

In case of strong electromagnetic interferences (EMI), parallel cable ducting with power lines, or when cable length exceeds 30 m we recommended to use shielded cable.

8. EXAMPLES OF ULM-70 CONNECTION

8.1. WIRING DIAGRAM OF THE LEVEL METER WITH CURRENT OUTPUT AND PDU UNIT

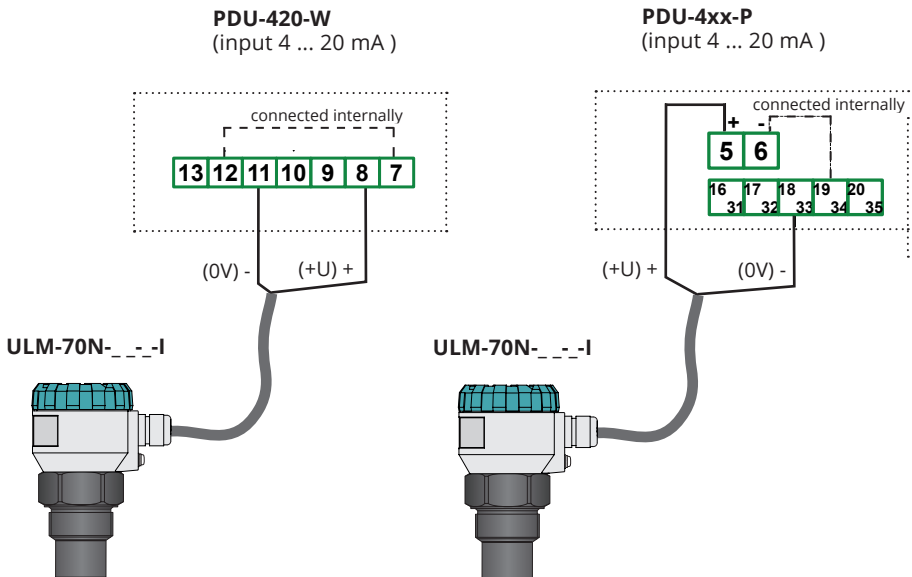

Connection of PDU-420-W is valid for firmware version 6.00 or higher. The older versions (up to version 5.99), the level meter output +U is connected to the terminal 7 and the output 0V to the terminal 10.

8.2. WIRING DIAGRAM OF THE LEVEL METER WITH CURRENT OUTPUT AND PDU UNIT IN VERSIONS FOR EXPLOSIVE AREAS

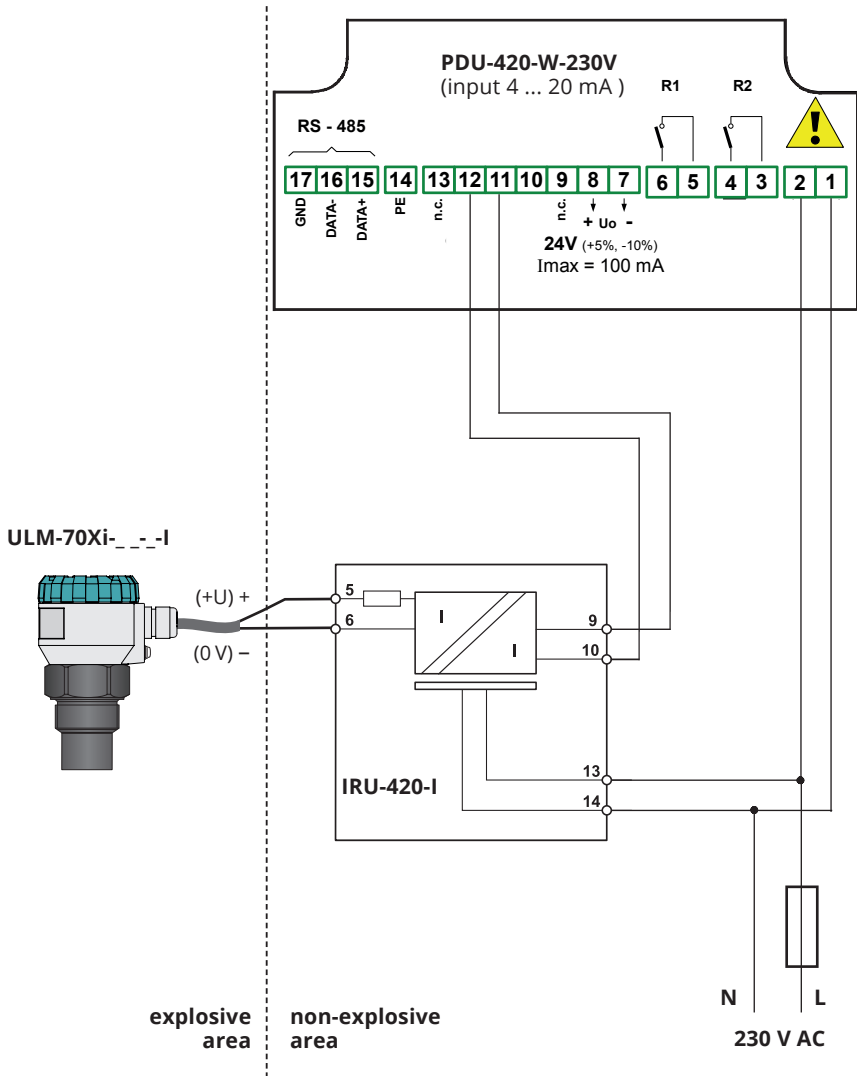

Connection of PDU-420-W is valid for firmware version 6.00 or higher. The older versions (up to version 5.99), the terminal 9 of the IRU unit is connected to the terminal 10 of the PDU unit and the terminal 10 of the IRU unit is connected to the terminal 11 of the PDU unit.

PDU-4xx-P-230V
(input 4 ... 20 mA)

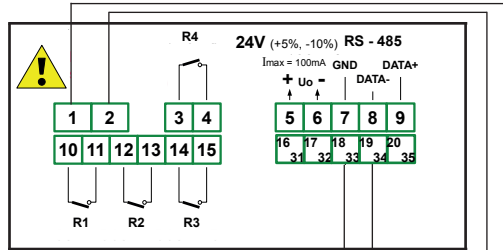

ULM-70Xi-_-_-I

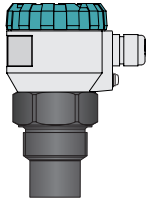

(+U) +
(0 V) -

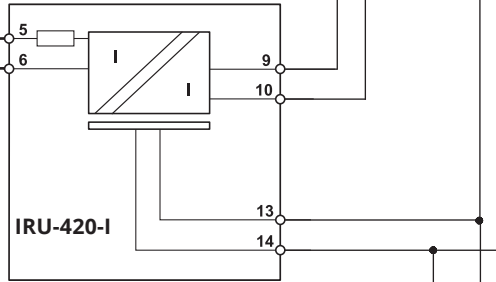

IRU-420-I

N L

230 V AC

explosive area non-explosive area

8.3. WIRING DIAGRAM OF THE LEVEL METER WITH CURRENT OUTPUT AND MGU UNIT

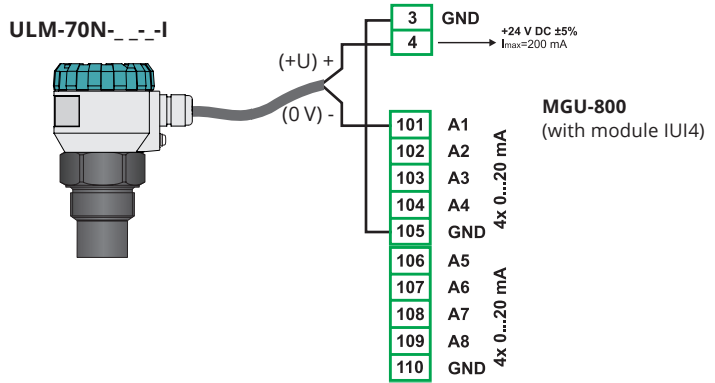

8.4. WIRING DIAGRAM OF THE LEVEL METER WITH MODBUS / RS485 AND MGU UNIT

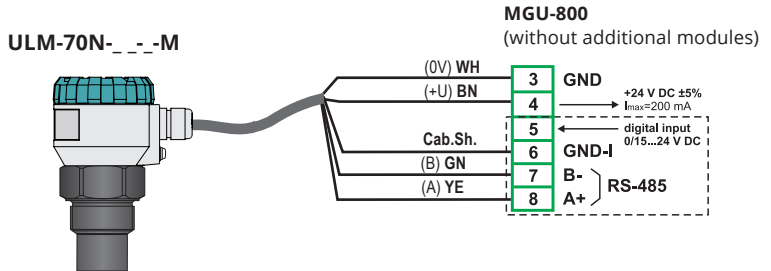

8.5. WIRING DIAGRAM OF THE LEVEL METER WITH MODBUS / RS485 AND PDU UNIT

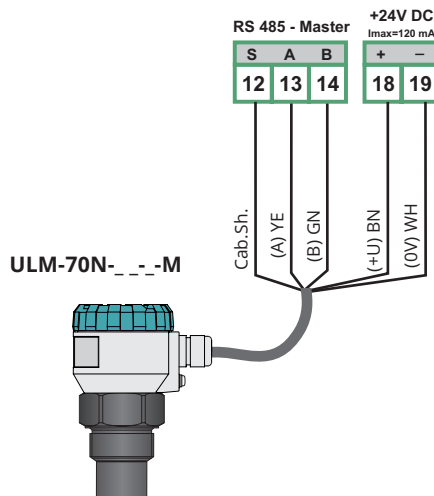

9. SET-UP ELEMENTS

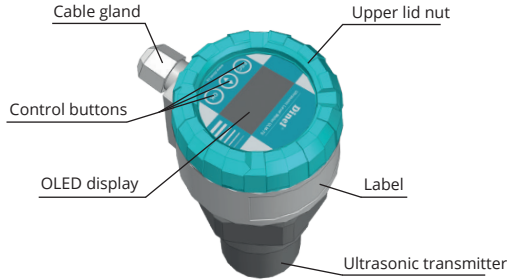

Fig. 20: Full view of the level meter

Button

- Set-up mode access
- Confirmation of selected item in the menu
- Move the cursor in the line
- Saving of set-up data

Button

- Move in the menu
- Change of values

Button

- Cancelling of carried out changes
- Shift one level up

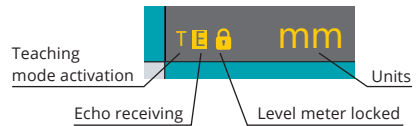
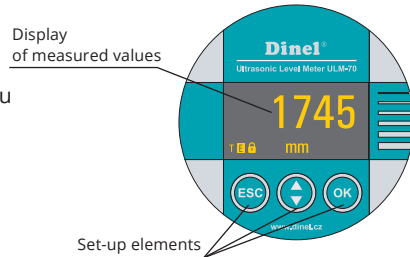

10. STATUS SIGNALIZATION

| display | function |
|--|---|
| "NO ECHO" | Lighting intermittently – the level meter is not able to receive echo for a long time. Incorrect installation of the level meter |
| "DEAD ZONE" | Lighting intermittently – the measured level is in the "dead zone" of the level meter or the ultrasonic converter is dirty. |
| "NO PASSWORD" | It will appear in the item "MENU" – the level meter is protected using a password against unauthorised setting. Enter the correct password (see p. 19). |
| Symbol "T" ¹⁾ | Lighting permanently – "TEACHING" mode activation. |
| Symbol "E" ¹⁾ | Lighting intermittently – correct echo receiving (of the reflected signal) from the measured surface level. |
| Symbol  ¹⁾ | Lighting permanently – level meter is locked against unauthorized settings by a password. You must enter the correct password to unlock it (see page 19). |

¹⁾symbol appears in the lower left corner of the display

11. OPERATION AND SETTING

Set the level meter using 3 buttons placed on the display module (see Chapter Set-up elements). After 5 min. of inactivity, the level meter automatically returns back to the measurement mode. If the password is active, the level meter will be also locked. The values that have not been confirmed using the button **OK** will not be saved! After the meter is locked, you cannot change the setting! When you attempt to edit, the words "NO PASSWORD" will appear on the display. How to unlock the level meter is given on page 16. After connection of the supply voltage to the level meter the display shows the logo "Dinel" and the text "Starting" (approx. 15 s). Then, the level meter goes to the measuring mode and the display shows the current measured value.

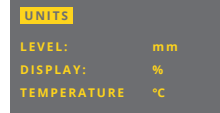

11.1. BASIC CONFIGURATION

After the first start of the level meter it is necessary to perform the basic configuration (setting of the measuring range, choice of units and possibly damping). The settings are accessible in the basic menu by pressing **OK** the "BASIC SETTINGS".

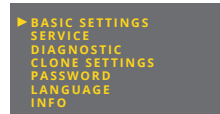

MIN LEVEL and MAX LEVEL

You can freely define the **minimum / maximum distance from the front surface of the level meter** (item "LEVEL" for currents 4 / 20 mA). The "DISPLAY" is intended to set the value displayed on the display. Setting the units is done in the "UNITS".

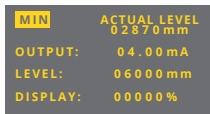
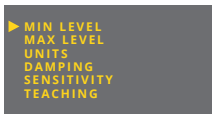

ACTUAL LEVEL: Actual distance to level

OUTPUT: current 4 mA / 20 mA

LEVEL: Definition of the min / max level

DISPLAY: The value showed on the display

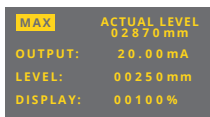

If in the bottom of the display appears (when entering the values) the inscription "OUT OF LIMITS", the value specified for the item "LEVEL" is outside the measuring range of the level meter. If the inscription "SPAN TOO SMALL" is shown, it must be specified a larger span between Min and Max values. For more information, see chapter "Specifications". The decimal point position of the item 'LEVEL' is firmly set (according to the selected units), in the item "DISPLAY" it is freely adjustable

1. To enter to the menu press **OK** the same button to select "BASIC SETTINGS". Then, using **↑** and **OK** select "MIN LEVEL" or "MAX LEVEL".
2. Now it is shown the item "MIN LEVEL" ("MAX LEVEL"). By pressing **OK** and **↓** set the output current "OUTPUT", the distance for the defined current "LEVEL" the value on the display "DISPLAY".
3. By pressing **OK** button save the data. By next presses of the button **ESC** leave the menu. The level meter returns to measurement mode.

UNITS

Level meter can process and convert a large number of different **physical values**. The setting is done in the item "UNITS".

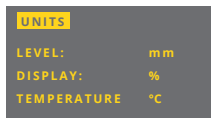

LEVEL: Unit selection (mm, cm, m, in, ft)
 DISPLAY: The unit showed on the display (% , mm, cm, m, in, ft, l, hl, m³, gal, bbl, mA)
 TEMPERATURE: Temperature unit (°C, °F)

1. To enter to the menu press **OK** the same button to select "BASIC SETTINGS". Then, using **↑** and **OK** select "UNITS".
2. Now the menu item "UNITS" is shown. By pressing the **OK** and **↓** button make the settings of individual items.
3. By pressing **OK** button save the data. By next presses of the button **ESC** leave the menu. The level meter returns to measurement mode.

DAMPING

Setting the **response time** of the measurements. The function is useful for suppressing level fluctuations, waves and rapid changes of the level. The reaction time will depend on the exponential function. Damping with a defined delay in seconds represents the time when exponential reaches 2/3 of its maximum value.

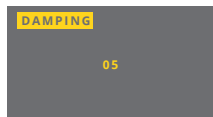

The damping time can be set in the interval from 0 to 99 s.

1. To enter to the menu press **OK** the same button to select "BASIC SETTINGS". Then, using **↑** and **OK** select "DAMPING".
2. Now the menu item "DAMPING" is shown. By pressing the **OK** and **↓** button make the settings of individual items.
3. By pressing **OK** button save the data. By next presses of the button **ESC** leave the menu. The level meter returns to measurement mode.

SENSITIVITY

The setting is defined in three steps of the level meter **sensitivity**.

"LOW" – Low sensitivity in case of surrounding interferences affecting the measurement.

"MEDIUM" – Medium sensitivity (suitable for most applications).

"HIGH" – Enhanced sensitivity for measured media partly absorbing the ultrasonic signal



You can set the sensitivity in three degrees:

LOW – MEDIUM – HIGH.

TEACHING

The mode serves for **suppressing false reflections** resulting from reflection of the ultrasonic signal from roughnesses on walls of the tank, various partitions, mixers or other obstacles. The sensor starting this mode detects false reflections and save them in the memory. Then these false reflections will not affect the subsequent measurement (they are masked).

Before starting the mode it is necessary to empty the tank as much as possible (preferably completely).



If there are no above obstacles in the tank, it is not necessary to start this mode.

1. To enter to the menu press the same button to select "SERVICE". Then, using and select "TEACHING".
2. Now it is shown the item "TEACHING". By pressing set the value "LEVEL DISTANCE" (distance to the level) – supposed distance from the face of the sensor to the medium level. If the distance to the level is not precisely known, enter a value rather lower (in the tolerance field as shown in Fig. 19).
3. After entering the "SET LEVEL DISTANCE" by pressing button the system starts "teaching" (false reflection mapping). During the mapping, the display shows flashing sign "RUNNING".
4. The mapping of false echoes can be completed when you see the inscription "Press OK to stop" and you press .
5. The procedure is completely finished when you can see the inscription "DONE". It is then possible to exit the menu by repeated pressing the button .



The mode "TEACHING" will stop automatically after ca. 1000 measurements.



If during the scanning of the tank in the bottom of the display appears the dialog "press OK to stop" (see figure) the level meter already found no further obstacles and "TEACHING" mode may be terminated. If it is not terminated, the level meter is still ready for the possible presence of obstacles (e.g. paddles of the agitator). Once it registers a further obstacle, the dialogue disappears and the obstacle is erased. This process may be repeated up to 1000 cycles. After this the "TEACHING" mode is automatically stopped.



In case of installed mixers, it is **necessary** to position the mixers under the level meter (direct the mixer blade to the ultrasonic signal beam).

Note: If there are significant obstacles in the upper half of the tank, **multiple false reflections** can occur especially in closed tanks. In such cases it is necessary to reduce the level in the tank as much as possible to correctly mask these possible multiple false reflections.

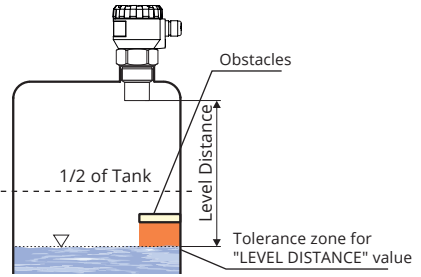
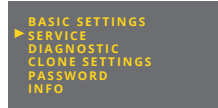

Fig. 21: Level distance zone

11.2. SERVICES SETTINGS

In the supplemented configuration, you can set parameters of sensitivity, mapping of false reflections, temperature difference compensation, behaviour in case of fault conditions or HART® communication. Here, you can set the sensor into the initial state or reset it as well. The settings are accessible in the basic menu under the item "SERVICE".



MEDIUM TEMPERATURE

The level meter is equipped with **automatic temperature compensation**. If for instance in the tank there is a difference of 10°C between the temperature of the measured material (medium) and the temperature at the mounting site of the level meter (see the mode "DIAGNOSTICS", page 20), the measuring accuracy will be reduced by around 1% of the set range. If this function is activated, this temperature difference can be compensated. If in the tank (open channel) is a big difference between the temperature of the measured medium (liquid) and temperature in the place of installation of the ULM (see mode, "DIAGNOSTICS" page 20), it is advised to improve the precision of the measurement by the zone temperature compensation. Otherwise, this mode is **not necessary to run**.



- Inactive compensation (initial state), the word "NO" appears on the display.
- See the "UNITS" menu for temperature unit selection (°C or °F).

After start of the **zone temperature compensation** mode it is necessary to set the temperature of the surface of the medium. The level meter then calculates the average value from the medium temperature and the temperature at the installation place of the level meter. With such an average temperature it counts in calculating of the velocity of acoustic waves propagation and for determination of the level position.

FAILURE MODE

It **defines the output current** of the level meter when the measured medium level is in the dead zone ("DEAD ZONE") or outside the measurement range in case of echo loss ("NO ECHO").

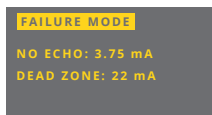

- NO ECHO: Current in case of echo loss
- DEAD ZONE: Dead zone current
- The values can be set in three steps: 3.75 mA, 22 mA and LAST (last measured data).

HART

HART® mode (point to point, multidrop) and multidrop mode **address setting**. Up to 15 units can be connected to one two-wired cable in the multidrop mode.

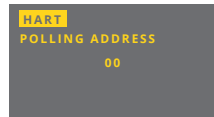
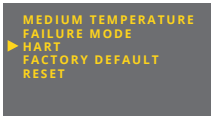

In case of the address "00", the point to point mode is enabled. The range from "01" to "15" is reserved for addresses in the multidrop mode.

MODBUS

This item is part of a menu with Modbus output level meter ULM-70 _-_- M. Modbus mode is intended for the settings of the level Modbus addresses, baud rate and parity settings.

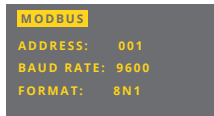
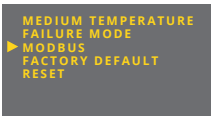

: ADDRESS: 1 to 247 (default 1)
: BAUD RATE: 4800, 9600, 19200
: (default 9600)
: FORMAT : 8N1, 8O1, 8E1, 8N2 (default 8N1)
: FORMAT:
: — number of stop bits: 1
: |
: └─ parity: N – non parity 2
: O – odd parity
: E – even parity
: data: 8 – number of bits

FACTORY DEFAULT

To **reset the initial values** of the level meter set by the manufacturer, press the button  (see the Factory default table, p. 28).

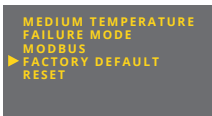

After you press the button , "RUNNING" will be displayed for about 3 sec. After the initial values are set, "DONE" will be appear on the display.



RESET

Complete restart of the level meter. The same effect has also a short-time interruption of the supply voltage. To enable the resetting, press the button .

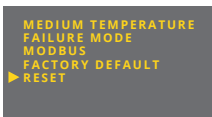

During the restart process, "RUNNING" will be displayed. Then the level meter will be automatically turned off and on.

11.3. ADDITIONAL FUNCTIONS

Additional functions include modes to display temperature in the tank or to find out the actual flowing current in the loop. Besides, to lock modifications using a password and information about the level meter version. All of the functions are accessible from the main menu.

DIAGNOSTICS

It contains information about the actual temperature inside the tank (or about the compensated temperature) "TEMPERATURE" and current flowing through the loop "CURRENT". If the temperature compensation ("MEDIUM TEMPERATURE") is activated, the corrected temperature is displayed.

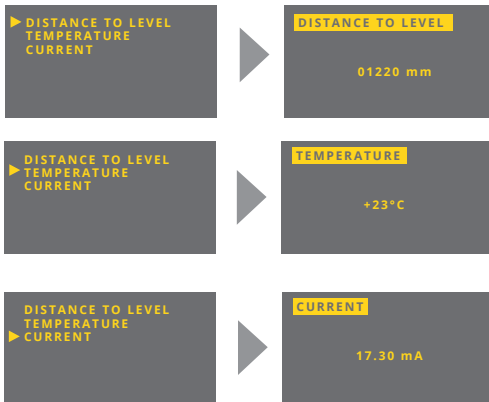
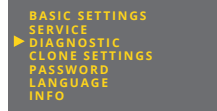

The temperature is measured inside the tank where the level meter is installed.

If the temperature of the measured medium is different, we recommend you to carry out the temperature compensation "MEDIUM TEMPERATURE" because of accuracy (see p. 15). Then the displayed temperature is an average value from the temperature set in the "MEDIUM TEMPERATURE" and the actual temperature measured by the sensor.

CLONE SETTINGS

This mode is intended for **copying** of the level meter (ULM-70 body) **configuration into the display module** (DM-70) and back. The display module can then be removed from the level meter body and put into another level meter and make there the settings transfer (cloning).

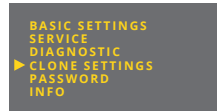

The "CLONE SETTINGS" mode transfers all data, excluding setting of the "Teaching" and HART®.

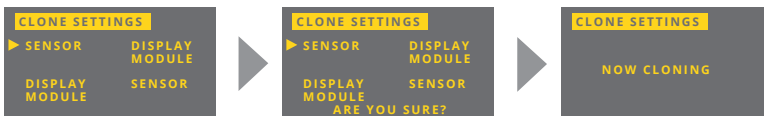

1. Press **OK** to enter the menu and select the item "CLONE SETTINGS". Copying of the settings from the body of the level meter to display module is done by selecting "SENSOR - DISPLAY MODULE". To transfer the settings from the display module to another level meter select the item DISPLAY MODULE - SENSOR.
2. The selected mode starts by pressing button **OK**. During transmission the display shows "NOW CLONING".
3. After completing the process in the middle of the screen displays "DONE". It is then possible to leave the menu and the mode by pressing the button **ESC**.



Incompatible type of level meter. Transfer of the settings can be realized only with the same type of level meter (e.g. ULM-70-02 - ULM-70-02, ULM-70-10 - ULM-70-10) and with the firmware version 2.0 and later.



The data set is not stored into the display module (DM-70). The transfer can not be done. It is necessary to repeat the procedure of the copying the settings in the mode "CLONE SETTINGS".

PASSWORD

You can **lock** the level meter data against **unauthorized editing**. After activating the password the data may be read, but can not be edited. If you try to edit the settings (without true password) the display shows "NO PASSWORD".



The password can be any 5-digit numeric combination. The combination of numbers 00000 is reserved for disabling the password.

1. Use the buttons and in the menu "PASSWORD" to select the mode "ENTER" for entering the password or the mode "CHANGE" for changing the password (when activated, the words are displayed inversely). Press the button once again to confirm the selection. You can change the password only when the level meter is unlocked. Otherwise, the words "NO PASSWORD" will be displayed.
2. Now you can edit the password. The actual edited item is displayed inversely. Press the button to move to the next position (clockwise direction), button serves to change the values (0 ... 9).
3. After the operation is completed, confirm the edited data by pressing the button .

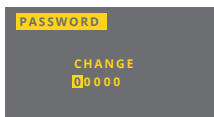
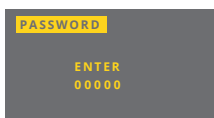
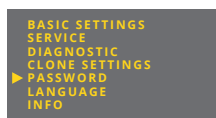

- Display of status information to confirm data:
- "YES" – correctly edited password
- "NO" – incorrectly edited password
- "OK" – the password saved (only in case of "CHANGE")
- The password is automatically hidden after it is edited or changed ("00000" will appear).
- To deactivate the password, edit the numerical combination "00000" in the mode "CHANGE".



The level meter with activated password will be automatically locked after 5 minutes of inactivity or after 5 min. from switching to measuring mode. Locking of level meter is indicated in the lower left corner of the screen by the letter "L".



If the password is lost, contact the manufacturer.

LANGUAGE

Setting the language of display menu.



You can set three kinds of language:
ČESKY – ENGLISH – по русски

INFO

Information about the type, serial number and production date of the level meter (type, serial number – SN and firmware version – SW).

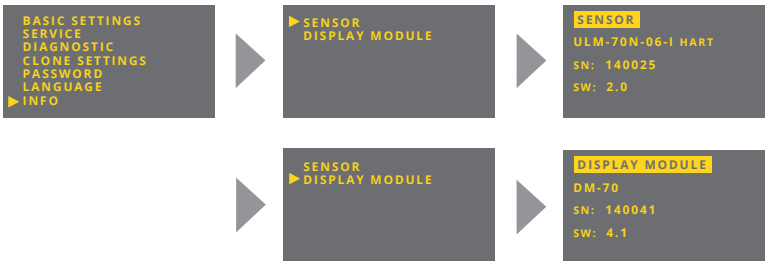

12. PROTOCOL HART®

Universal communication interface for data communication of peripheral devices with the level meter. Data transmission runs through the same line as the 4 ÷ 20mA current loop without impact on analog communication. For setting the level meter and collection of measured data, it is necessary to have available a HART communicator, by which it is possible to communicate directly with the level meter, or using it, to mediate communication with a peripheral device, see image 22.

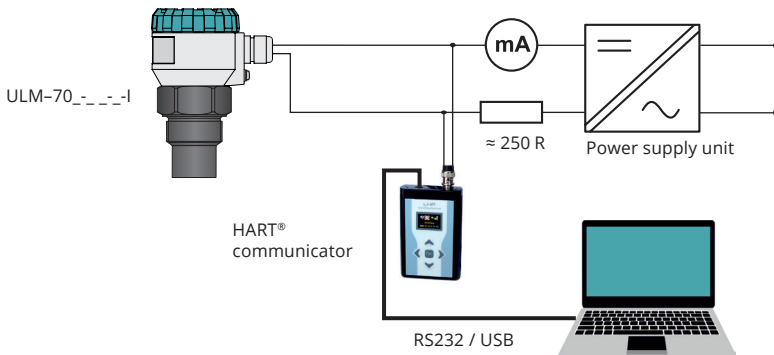

Obr. 22: Typical hardware configuration with HART

HART Specifications

The version of the HART Protocol is revision 5.

Universal Commands: 0, 1, 2, 3, 6, 11, 12, 13, 14, 15, 16, 17, 18, 19 and

Commons Practice Commands: 34, 35, 40, 42, 44, 49.

13. PROTOCOL MODBUS®

Data communication takes place along a series line of a standard RS-485 with protocol Modbus RTU. A list of relevant variables is provided in a separate annex.

To set up the level meter and collect measured data, you can use the software application "Basic SCADA", which is freely available at the Website www.dinel.cz. Connecting the level meter to a peripheral device can be performed using a converter URC-485, see image 23.

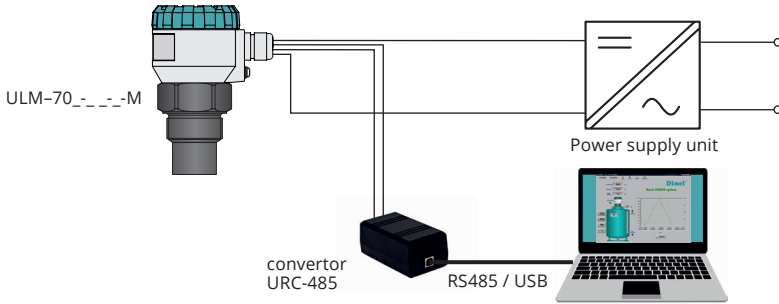

Obr. 23: Typical hardware configuration with Modbus®

14. ORDER CODE

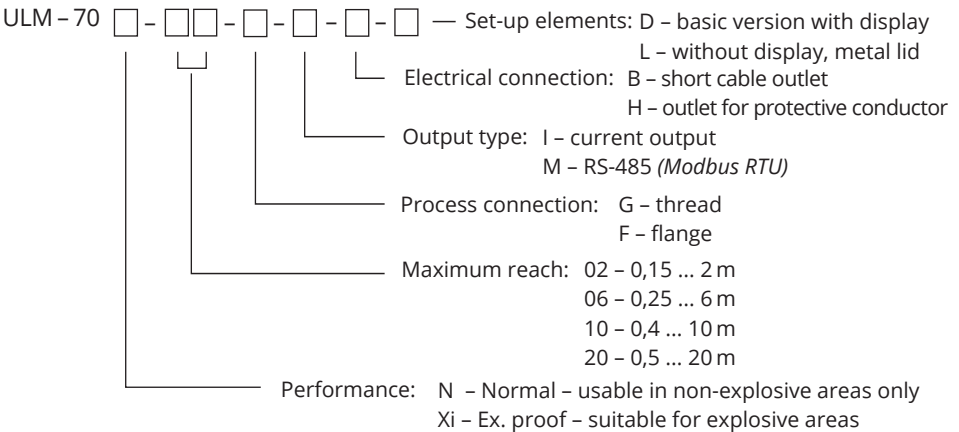

15. ACCESSORIES

Standard – incl. in the price of the level sensor **Optional** – for extra charge

- 1 pc of Seal (for ULM-70_02-I, 06-I)
- free-to-download programme Basic Scada Level (for the Modbus version)
- Fixing nuts G1" and G1 ½" and G2 ¼
- Horn adapter ST-G1, STG1,5 and ST-G2,25
- for version Modbus converter URC-485

16. SAFETY, PROTECTION, COMPATIBILITY AND EXPLOSION PROOF

The level meter ULM-70 is equipped with protection against reverse polarity and output current overload.

Protection against dangerous contact is secured by low safety voltage that complies with EN 33 2000-4-41.

Electromagnetic compatibility according to EN 55022/B, EN 61326/Z1 and EN 61000-4-2 to 6. Explosion proof of ULM-70Xi type complies with the following standards: EN 60079-0 : 2007; EN 60079-11 : 2007 ; EN 60079-26 : 2007 and examined by FTZÚ-AO 210 Ostrava - Radvanice certificate No.: FTZÚ 09 ATEX 0277X.

Special conditions for safe use ULM-70Xi:

The device is designed for connection to the isolating repeater IRU-420. When the other approved supply unit is used, whose output parameters satisfy above mentioned output parameters, it is necessary to have a galvanic separation or, if supply unit without galvanic separation is used (Zener barriers), it is necessary provide potential equalization between sensor and point of barrier earthing.

For application in zone 0 the present explosive atmospheres - mixture of air with flammable gases, vapour or mists must comply: $0,8 \text{ bar} < p < 1,1 \text{ bar}$. The device must be installed in such a way, to prevent mechanical damage of sensor face. It is necessary carried out earthing by screw which is placed on head of level meter.



The device must be installed in such a way, to prevent mechanical damage of sensor face.

17. USE, MANIPULATION AND MAINTENANCE

The level meter does not require any personnel for its operation. Follow-up displaying device is used to inform the technological entity operating personnel on the measured substance level height during the operation.

Maintenance of this equipment consists in verification of integrity of the level meter and of the supply cable. Depending on the character of the substance measured, we recommend to verify at least once per year the clarity of the ultrasound transducer emitting field and to clean it, respectively. In case any visible defects are discovered, the manufacturer or reseller of this equipment must be contacted immediately.



It is forbidden to perform any modifications or interventions into the ULM-70 level meter without manufacturer's approval. Potential repairs must be carried out by the manufacturer or by a manufacturer authorized service organization only.

Installation, commissioning, operation and maintenance of the ULM-70 level meter has to be carried out in accordance with this instruction manual; the provisions of regulations in force regarding the installation of electrical equipment have to be adhered to.

Installation in areas with potentially explosive atmospheres must be carried out in accordance with standard EN 60079-14 (Electrical apparatus for explosive gas atmospheres - Part 14: Electrical installations in hazardous areas other than mines) and respectively in accordance with other standards that apply to a given area.

The device must be installed to prevent tensile overload rope electrode level meter.

18. MARKING OF LABELS

Labels for type of ULM-70N-_-_-I-_-:

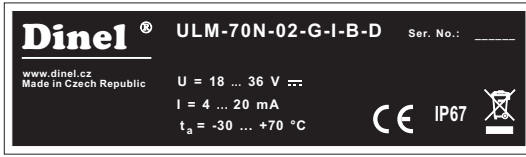

Example of label for type of ULM-70N-02-G-B-D

Symbol of producer: logo Dinel®

Internet address: www.dinel.cz

Level meter type: ULM-70N-_-_-I-_-

Serial number: Ser. No.: xxxxx - (from the left: production year, serial production number)

Supply voltage: $U_i = 18 \dots 36 \text{ V}$

Output current range: $I = 4 \div 20 \text{ mA}$

Ambient temperature range: $t_a = -30 \dots + \dots \text{ °C}$ (see. Temperature range according to type)

Protection class: IP67

Compliance mark: **CE**

Electro-waste take-back system mark:

Temperature range according to type:

| | |
|----|----------------------------------|
| 02 | $t_a = -30 \dots +70 \text{ °C}$ |
| 06 | $t_a = -30 \dots +70 \text{ °C}$ |
| 10 | $t_a = -30 \dots +60 \text{ °C}$ |
| 20 | $t_a = -30 \dots +60 \text{ °C}$ |

Labels for type of ULM-70Xi-_-_-I-_-:

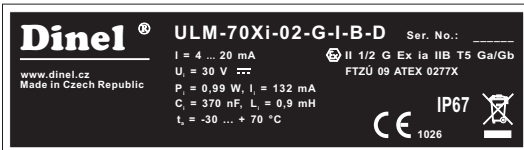

Example of label for type of ULM-70Xi-02-G-I-B-D

Symbol of producer: logo Dinel®

Internet address: www.dinel.cz

Level meter type: ULM-70Xi-_-_-I-_-

Serial number: Ser. No.: xxxxx -

(from the left: production year, serial production number)

Output current range: $I = 4 \dots 20 \text{ mA}$

Max. internal values: $U_i = 30 \text{ V}$, $I_i = 132 \text{ mA}$; $P_i = 0,99 \text{ W}$; $C_i = 370 \text{ nF}$; $L_i = 0,9 \text{ mH}$

Ambient temperature range: $t_a = -30 \dots + \dots \text{ °C}$ (viz. Teplotní rozsah dle typu)

Label of non-explosive device: , Performance: II_G Ex ia II_T5_/

Number of certificate of intrinsically safety: FTZÚ 09 ATEX 0277X

Protection class: IP67

Compliance mark: **CE**, No. of authorized person examining control of system quality: 1026

Electro-waste take-back system mark:

Classification non-explosive performance:

| | |
|----|--|
| 02 | |
| 06 | |
| 10 | |
| 20 | |

Temperature range according to type:

| | |
|----|----------------------------------|
| 02 | $t_a = -30 \dots +70 \text{ °C}$ |
| 06 | $t_a = -30 \dots +70 \text{ °C}$ |
| 10 | $t_a = -30 \dots +60 \text{ °C}$ |
| 20 | $t_a = -30 \dots +60 \text{ °C}$ |

Labels for type of ULM-70N-__-M-__:

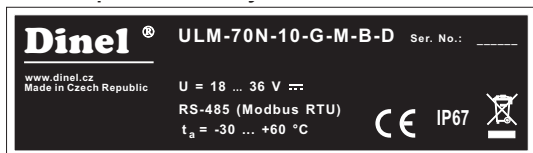

Temperature range
according to type:

| | |
|----|--------------------|
| 02 | ta = -30 ... +70°C |
| 06 | ta = -30 ... +70°C |
| 10 | ta = -30 ... +60°C |
| 20 | ta = -30 ... +60°C |

Example of label for type of ULM-70N-10-G-M-B-D

Symbol of producer: logo Dinel®

Internet address: www.dinel.cz

Level meter type: ULM-70N-__-M-__

Serial number: Ser. No.: xxxxx - (from the left: production year, serial production number)

Supply voltage: U = 18 ... 36 V =

Data output: RS-485 (Modbus RTU)

Ambient temperature range: t_a = -30 ... +__ °C (see. Temperature range according to type)

Protection class: IP67

Compliance mark: CE

Electro-waste take-back system mark:



Real label size is 70x20mm.

19. MENU STRUCTURE

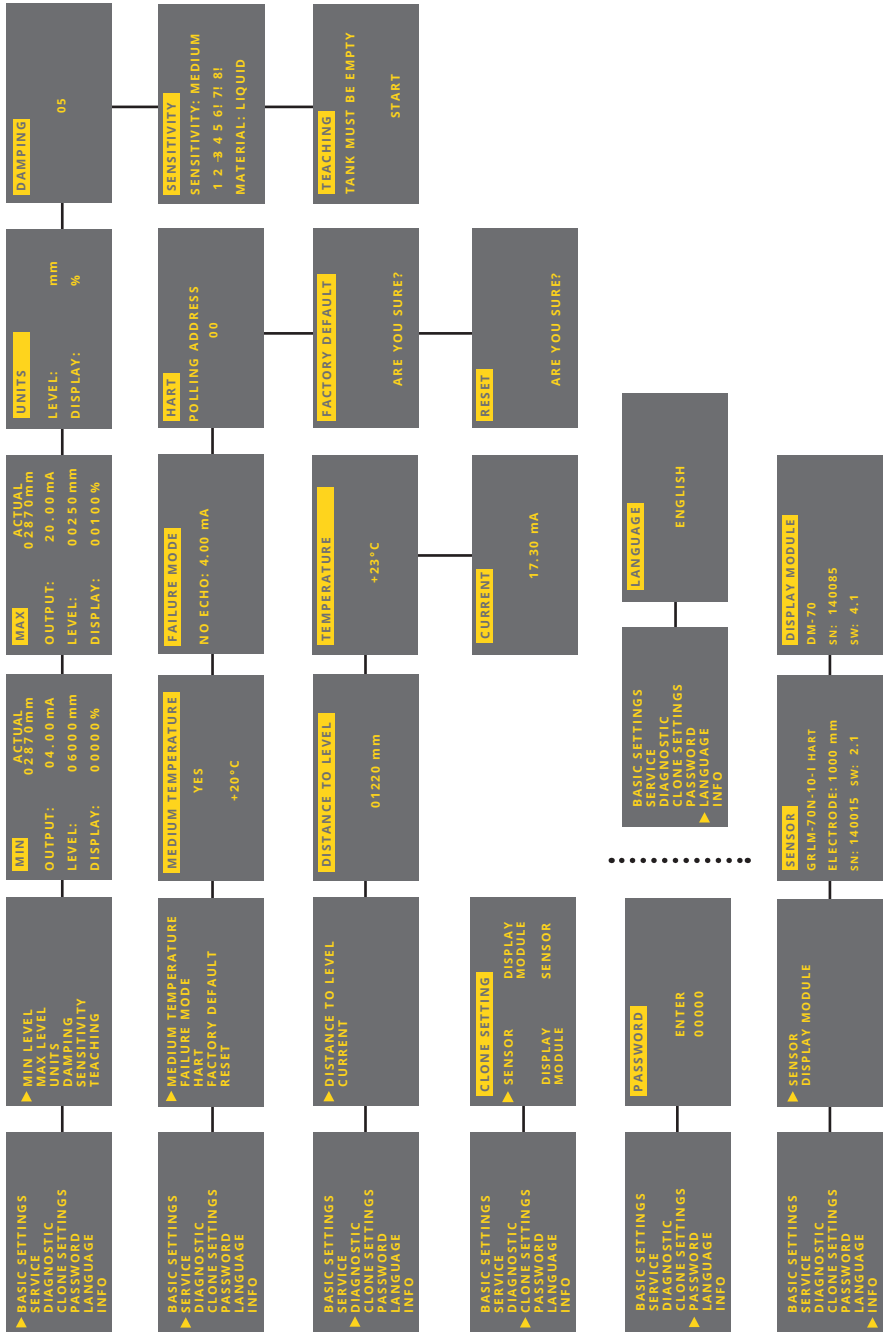

20. SPECIFICATIONS

| TECHNICAL SPECIFICATIONS – LEVEL METER | | |
|--|--|---|
| Measuring range ¹⁾ | ULM-70_-02 ULM-70_-06 ULM-70_-10 ULM-70_-20 | 0.15 ... 2 m 0.25 ... 6 m 0.4 ... 10 m 0.5 ... 20 m |
| Adjustable measuring range (SPAN) | | Min. 200 mm |
| Supply voltage | ULM-70N-__ ULM-70Xi-__ | 18 ... 36 V DC 18 ... 30 V DC |
| Output | ULM-70_-_-_-I ULM-70_-_-_-M | 4 ... 20 mA (Limit values 3.9 ... 20.5 mA), HART® RS-485 with protocol Modbus RTU |
| Current consumption | ULM-70_-_-_-I ULM-70_-_-_-M | 4 ... 20 mA / Max. 22 mA Max. 20 mA |
| Resolution | ULM-70_-02; 10 ULM-70_-06 ULM-70_-20 | < 1 mm < 2 mm < 2.5 mm |
| Accuracy (within the total range) | | 0.15 % |
| Temperature error | | Max. 0.04% / K |
| Operating frequency | ULM-70_-02 ULM-70_-06 ULM-70_-10 ULM-70_-20 | 120 kHz 75 kHz 50 kHz 30 kHz |
| Beamwidth (-3 dB) | ULM-70_-02; 10 ULM-70_-06 ULM-70_-20 | 10° 14° 12° |
| Ambient temperature range | ULM-70_-02; 06 ULM-70_-10; 20 | -30 ... +70 °C -30 ... +60 °C |
| Short-time temperature stress resistance | | +90 °C / 1 hour |
| Max. operation overpressure (on transmission surface) | | 0.1 MPa |
| Sensitivity | | 3 steps (low – medium – high) |
| Damping | | 0 ... 99 s |
| Measuring period | | 1 ... 4 s |
| Rise time | | ca. 30 s |
| Additional technical data for Ex proof ²⁾ – Max. internal values | | U=30 VDC; I _L =132 mA; P _I =0.99 W; C _I =370 nF; L _I =0.9 mH |
| Failure indication (echo loss, level in dead zone ³⁾ , internal failure) | | Adjustable in modes: 3.75 mA; 22 mA; Last measured value |
| Maximal resistance of current output load (U = 24 VDC) | | R _{max} = 270 Ω ⁴⁾ |
| Mechanical connection | ULM-70_-02 ULM-70_-06 ULM-70_-10 ULM-70_-20 | Screwing with thread G 1" Screwing with thread G 1½" Screwing with thread G 2¼" Aluminium alloy flange |

¹⁾ In case the level of bulk-solid materials is measured, the measurement range is reduced.

²⁾ Allowed pressure range in the zone 0: 80 ... 110 kPa.

³⁾ Dead zone = Blind zone = Blocking distance

⁴⁾ Including 250Ω resistor in case of HART® connection.

TECHNICAL SPECIFICATIONS – LEVEL METER

| | | |
|------------------|--|--------------------------------------|
| Protection class | | IP67 |
| Weight | ULM-70_-02 ULM-70_-06 ULM-70_-10 ULM-70_-20 | 0.3 kg 0.4 kg 0.6 kg 3.1 kg |

TECHNICAL SPECIFICATIONS – DISPLAY MODULE

| | |
|--|-----------------------|
| Display type | Matrix OLED |
| Resolution | 128 x 64 pixel |
| Character height / Number of digits measured value | 9 mm / 5 Digits |
| Display colour | Yellow |
| Buttons | Membrane switch panel |
| Ambient temperature range | -30 ... +70 °C |
| Weight | 46 g |

USED MATERIALS



| Sensor part | Variants | Standard material |
|---------------------------|-----------------------------|-------------------------------------|
| Lid | All types | aluminium alloy with powder coating |
| Glass | All types | polycarbonate |
| Body | All types | aluminium alloy with powder coating |
| Housing with thread | All types | plastic PP |
| Electroacoustic converter | All types | plastic PVDF |
| Display module | ULM-70_...-D (with display) | plastic POM |
| Cable gland | All types | plastic PA |
| Flange | ULM-70-20-F | aluminium alloy with powder coating |

FACTORY DEFAULT

| | ULM-70_-02 | ULM-70_-06 | ULM-70_-10 | ULM-70_-20 |
|--|-------------|-------------|-------------|-------------|
| MIN LEVEL (Distance to min. level) | 2 000 | 6 000 | 10 000 | 20 000 |
| MAX LEVEL (Distance to max. level) | 150 | 250 | 400 | 500 |
| UNITS | mm; %; °C | mm; %; °C | mm; %; °C | mm; %; °C |
| DAMPING | 2 | 5 | 10 | 10 |
| SENSITIVITY | MEDIUM | MEDIUM | MEDIUM | MEDIUM |
| MEDIUM TEMPERATURE | NO | NO | NO | NO |
| FAILURE MODE – NO ECHO | 3.75 mA | 3.75 mA | 3.75 mA | 3.75 mA |
| FAILURE MODE – DEAD ZONE ¹⁾ | 22 mA | 22 mA | 22 mA | 22 mA |
| POOLING ADDRESS (HART®) | 00 | 00 | 00 | 00 |
| PASSWORD | No password | No password | No password | No password |

¹⁾ Dead zone = Blind zone = Blocking distance

AREA CLASSIFICATION (according to EN 60079-10 and EN 60079-14)

| | |
|----------------------------|---|
| ULM-70N-__ | Performance for non-explosive areas |
| ULM-70Xi-02 ULM-70Xi-06 | Explosive proof – suitable for explosive areas (combustible gases or vapours)  II 1/2G Ex ia IIB T5 Ga/Gb with Isolating repeater (IRU-420), the whole level meter – zone 1, front head part – zone 0 |
| ULM-70Xi-10 | Explosive proof – suitable for explosive areas (combustible gases or vapours)  II 1/2G Ex ia IIA T5 Ga/Gb with Isolating repeater (IRU-420), the whole level meter – zone 1, front head part – zone 0 |
| ULM-70Xi-20 | Explosive proof – suitable for explosive areas (combustible gases or vapours)  II 2G Ex ia IIA T5 Gb with Isolating repeater (IRU-420), the whole level meter – zone 1 |

21. PACKAGING, SHIPPING AND STORAGE

The device DLM-35 is packaged in a polyethylene bag, and the entire consignment is placed into a cardboard box. A suitable filler material is used in the cardboard box to prevent mechanical damage during transport. Remove the device from the packaging only just before using, thereby protecting it from potential damage.

A forwarding company will be used to ship goods to the customer. Upon prior agreement, ordered goods can be picked up in person at company headquarters. When receiving, please check to see that the consignment is complete and matches the order, or to see if any damage has occurred to the packaging and device during transport. Do not use a device clearly damaged during transport, but rather contact the manufacturer in order to resolve the situation.

If the device is to be further shipped, it must be wrapped in its original packaging and protected against impact and weather conditions.

Store the device in its original packaging in dry areas covered from weather conditions, with humidity of up to 85 % without effects of chemically active substances. The storage temperature range is -20°C to +60°C.



Level meters of variants ULM-53_ 02, 06, 10 are fitted with protective caps to prevent damage to the ultrasonic transducer. Remove the cover prior to putting into operation.

USED SYMBOLS

To ensure maximum safety of control processes, we have defined the following safety instructions and information. Each instruction is labeled with the appropriate pictogram.



Alert, warning, danger

This symbol informs you about particularly important instructions for installation and operation of equipment or dangerous situations that may occur during the installation and operation. Not observing these instructions may cause disturbance, damage or destruction of equipment or may cause injury



Information

This symbol indicates particularly important characteristics of the device.



Note

This symbol indicates helpful additional information.

Dinel[®]

industrial electronics

Dinel, s. r. o.

U Tescomy 249
760 01 Zlín
Česká republika

tel.: +420 577 002 003
e-mail: sale@dinel.cz

www.dinel.cz

This project was realised under financial support from the funds of the state budget through the "Department of Trade and Industry".

The latest version of this instruction manual can be found at www.dinel.cz
Version: 06/2019



QMS
ISO 9001

