



CAPACITIVE LEVEL SWITCH CLS-53

CONTENT

Safety	3
Measuring principle	3
Range of application	3
Features of variants	3
Dimensional drawing	4
Installation instructions	4
Electrical connection.....	5
Set-up elements.....	6
Status and failure signalization.....	7
Setting up	7
Order code	8
Accessories	8
Safety, protection and compatibility.....	8
Use, manipulation and maintenance	8
Technical specifications.....	9

SAFETY

All operations described in this instruction manual have to be carried out by trained personnel or by an accredited person only. Installation, commissioning, operation and maintenance of the CLS-53 capacitive level switch has to be carried out in accordance with this instruction manual; the provisions of regulations in force regarding the installation of electrical equipment have to be adhered to.

Improper use, installation or set-up of the sensor can lead to crashes in the application, (overflowing of the tank or damage of system components).

The manufacturer is not responsible for improper use, loss of work caused by either direct or indirect damage, and for expenses incurred at the time of installation or during the period of use of the sensor.

Customer service must be carried out by the manufacturer exclusively.

MEASURING PRINCIPLE

The CLS® sensor utilizes the capacitive principle. That means that the sensor measures the capacity among the electrodes in an electrode system over the area scanned. If the level of medium changes (the scanning field is totally or partially filled up), the capacity volume changes as well. The sensor's evaluation electronics subsequently changes the output state.

RANGE OF APPLICATION

Detection of various kinds of bulk-solid materials (pellets, wood chips, granulates, cereals, sand, gravel and the like) in hoppers, containers, silos, etc.

FEATURES OF VARIANTS

CLS-53N-SAC **2-wire connection** with electronic current switch directly connected to the relay circuit. Supply voltage up to 250 V AC/DC. The sensor is not suitable for direct connection to a binary input of the control system (PLC).

CLS-53N-P(N) **3-wire connection** with NPN or PNP output for connected to Dinel supply and switching units or binary input of PLC.

DIMENSION DRAWING

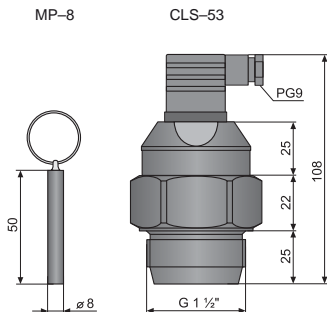

INSTALLATION INSTRUCTIONS

- The sensor can be installed in any position using a welding flange or a fixing nut.
- The sensor should be mounted to a slant or vertical wall of the hopper using a welding flange with $G 1 \frac{1}{2}''$ thread. The front of the sensor stands 1 to 5 mm behind the inner wall.
- When mounting the sensor onto a slant wall or on a bin sidewall using a fixing nut, some sticking materials can get stuck above the fixing nut. As a result, might cause false activation (locking) of the sensor. (see Fig. 2).

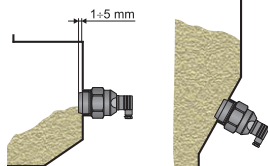

Fig. 1: Installation of the sensor using a welding flange

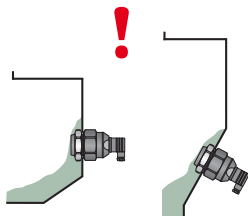

Fig. 2: Sticking of material when installed with a fastening nut

- The sensor must not be installed in places with direct **solar radiation** and must be protected against weather conditions. In case the installation at places with direct solar radiation is inevitable, it is necessary to mount a **shielding cover** above the sensor (Fig. 3).
- If possible, insert the cable from above and let a **drain-ing loop** in order to avoid intrusion of humidity (Fig. 4).
- The cable bushing as well as the connector's safety screw have to be **tightened sufficiently**.
- The emplacement of the **filling point** must be carried out in such a way that the subsequent material flow does not interfere with the sensor's scanning field. False activation (blocking) of the sensor could follow (Fig. 5).

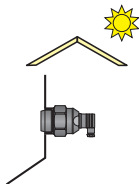

Fig. 3: Shielding cover against direct solar radiation

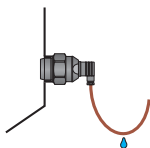

Fig. 4: Prevention to avoid intrusion of humidity

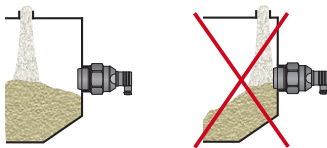

Fig. 5: Location of the filling point

ELECTRICAL CONNECTION

CLS-53N-SAC

The phase conductor (positive supply pole +U in case DC voltage) is connected through the device (relay, contactor) to terminal (1), neutral conductor (N) (negative pole 0V) to terminal (2). The terminal \perp is connected to ground.

Connection to supply voltages must be done through fuse or circuit breaker only!

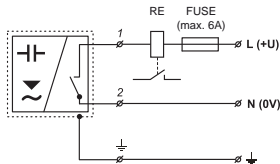

Fig. 6: 2-wire connection scheme
CLS-53N-SAC

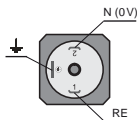

Fig. 7a: Top view on the connector

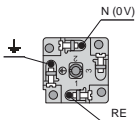

Fig. 7b: Inside of the connector socket

Caution:

The sensor CLS-53N-SAC is not equipped with protection against current overload. Low resistance loads (bulbs) or capacity loads can **damage the sensor!**

CLS-53N-P(N)

Sensor with NPN or PNP output is allowed to lead only by resistive or inductive lead. Positive supply voltage (+U) is connected to terminal (1), negative (0V) to terminal (2) and the leads to terminal (3). It is recommended to lead the cable separately from power distribution leads and strong sources of EMI (pulse converters, electric motors etc.).

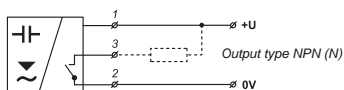
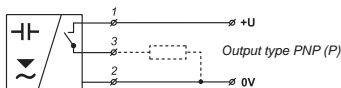

Fig. 8: 3-wire connection scheme CLS-53N-P(N)

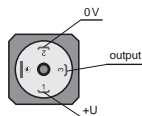

Fig. 9a: Top view on the connector

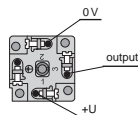

Fig. 9b: Inside of the connector socket

Caution:

The sensor CLS-53N-P(N) is equipped with protection against over-voltages and current overload. The capacity loads and low resistance (bulb) is evaluated by the sensor as short circuit.

SET-UP ELEMENTS

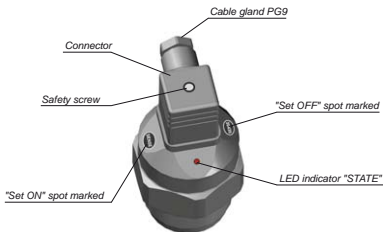

Fig. 10: Full view of capacitive level switch

spot marked "**set ON**" and "**set OFF**"

- for setting of the sensitivity and the switching mode

LED indicator "**STATE**"

- sensor status signalling

Setting-up can be performed with a "MP-8" magnetic pen that is a part of of the delivery.

STATUS AND FAILURE SIGNALIZATION

LED indicator	color	function
"STATE"	red	Shine – sensor is switched ON Darks – sensor is switched OFF Blinks – sensor did not recog. upper and lower level limit or mistake occurred during setting 4 times short flash – attaching the magnetic pen to "SENSE" spot

SETTING UP

The setting is performed by means of attaching magnetic pen MP-8 to "**SENSE**" spots placed next to the connector and marked with "**set ON**" or "**set OFF**". Such method is used for setting of the sensitivity and the switching mode. The "**mode O**" – normally open (opens when the level drops) and "**mode C**" – normally closed (connects when the level drops). When attaching the magnetic pen to "**SENSE**" spot, LED indicator "**STATE**" shortly flashes four times.

Set-up of the "O" mode

1. When the level is low (the container is empty), attach the magnetic pen MP-8 to the "**SENSE**" spot marked with "**set OFF**" for approx. 3 seconds
2. When the level is high (the container is full), attach the magnetic pen MP-8 to the "**SENSE**" spot marked with "**set ON**" for approx. 3 seconds "**set ON**". The LED indicator "**STATE**" will be shining and the output will be closed.

Set-up of the "C" mode

1. When the level is low (the container is empty), attach the magnetic pen MP-8 to the "**SENSE**" spot marked with "**set ON**" for approx. 3 seconds.
2. When the level is high (the container is full), attach the magnetic pen MP-8 to the "**SENSE**" spot marked with "**set OFF**" for approx. 3 seconds. The LED indicator "**STATE**" will be dark and the output will be opened.

Note: Rough adjustment of sensitivity can be performed in the smaller auxiliary bin by immersing the sensor into the measured substance.

ORDER CODE

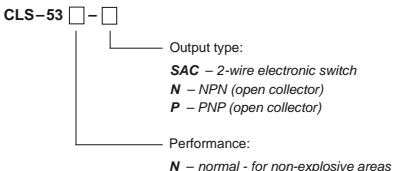

ACCESSORIES

standard – included in the price of the sensor

- 1 pcs. MP-8 magnetic pen
- 1 pcs. Seal
- 1 pcs. Connector with protection class IP65

SAFETY, PROTECTION AND COMPATIBILITY

CLS-53N-SAC:

The sensor is equipped with protection against reverse polarity and short time over-voltages. The sensor is not equipped with protection against current overload. Electrical equipment of protection group II. Electrical safety according to EN 61010-1.

CLS-53N-P(N)

The sensor is equipped with protection against reverse polarity, short time over-voltages and current overload.

For all types:

Electromagnetic compatibility is provided by conformity with standards: EN 55022, EN 61000-6-2, and -3, EN 61000-4-2, -3, -4, -5, -6 and EN 61000-4-11.

USE, MANIPULATION AND MAINTENANCE

The sensor does not require any personnel for its operation.

Maintenance of this equipment consists in verification of sensor's and supply cable's integrity. In case any visible defects are discovered, the manufacturer or reseller of this equipment must be contacted immediately.

It is forbidden to perform any modifications or interventions into the CLS-53 device without manufacturer's approval. Potential repairs must be carried out by the manufacturer or by an authorised service organization only.

Installation, commissioning, operation and maintenance of the CLS-53 sensor has to be carried out in accordance with this instruction manual; the provisions of regulations in force regarding the installation of electrical equipment have to be adhered to.

TECHNICAL SPECIFICATION

Supply voltage	CLS-53N-SAC	20 ... 230 V AC/DC $\pm 10\%$ 50 \div 60 Hz
	CLS-53N-P(N)	7 ... 36 V DC
Switched current	CLS-53N-SAC	min. 4 mA / max. 300 mA
	CLS-53N-P(N)	max. 200 mA
Supply current (OFF state)	CLS-53N-SAC	1.7 mA
	CLS-53N-P(N)	9.0 mA
Output		setting O/C
Max. remanent voltage (ON state)	CLS-53N-SAC	max. 6.0 V
	CLS-53N-P(N)	max. 1.5 V
Max. switching frequency		0.5 Hz
Ambient temperature range		-20 ... +60°C
Protection class		IP65
Connection cable type		3 x 1.5 mm ²
Housing material		PP and PVC-U
Weight		approx. 0.13 kg

Dinel[®]

industrial electronics

Dinel, s.r.o.
U Tescomy 249
760 01 Zlín
Czech Republic

Phone: +420 577 002 003
Fax: +420 577 002 007
E-mail: sale@dinel.cz

www.dinel.cz

The latest version of this instruction manual can be found at www.dinel.cz

Version: 10/2009

