

- For continuous level measurement of liquid and bulk-solid materials
- Direct mounting into containers, silos, vessels, basins, reservoirs, etc
- Variants with rope electrode or with coated electrode for aggressive and electrically conductive medium
- Possibility of linear measurements even in nonconductive and differently shaped vessels
- Variants for usage in explosive areas, high temperature performance
- Current (4 ... 20 mA) or voltage (0 ... 10 V) output



Capacitive level meters **CLM**<sup>®</sup> are designed for continuous level measurement of liquids, powders and bulk-solid materials in vessels, tanks, sumps, containers, silos, etc. CLM consists of the stainless steel housing with electronic module and the measuring electrode. The electronic part converts the capacity into the current signal (4 ... 20 mA) or voltage signal (0 ... 10 V). Sensitivity (SPAN) and initial capacity compensation (ZERO) can be fluently set.

Level meters are produced in the following performances: **N** – for non-explosive areas, **NT** – high temperature for non-explosive areas, **Xi** – Explosion proof – intrinsically safe for hazardous (explosive) areas and **XiT** - high-temperature conf. for explosive environments. CLM are offered in variants with various types of process connection (thread, Tri-clamp).

### VARIANTS OF SENSORS

- **CLM-36\_-10**     **With uncoated rod electrode** for level measurement of non-conductive liquids (oils, diesel, petrol) and powder or bulk-solid materials (flour, sand, cement, plastic granulates, etc.). Electrode length from 0.2 m to 5 m (for materials with a low permittivity  $\epsilon_r < 10$ , the minimum electrode length is 0.5m).
- **CLM-36\_-11**     **With fully (PFA) coated rod electrode** suitable for surface level measurement of water and other electrically conductive liquids. Also suitable for polluted liquids in metallic storage tanks, concrete sumps, etc. Electrode length from 0.2 m to 3 m.
- **CLM-36\_-12**     **With fully (FEP) coated rod electrode** suitable for surface level measurement of water and other electrically conductive liquids. Also suitable for polluted liquids in metallic storage tanks, concrete sumps, etc. Electrode length from 0.2 m to 3 m.
- **CLM-36\_-20**     **With uncoated rod electrode and reference tube** for accurate level measurement of clean non-conductive liquids (oils, diesel, petrol). Electrode length from 0.2 m to 3 m.
- **CLM-36\_-22**     **With fully FEP coated rod electrode and reference tube** for surface level measurement of electrically conductive liquids, (e.g. in plastic or glass storage tanks) and where greater measurement accuracy is required. Electrode insulation from FEP material. Electrode length from 0.2 m to 3 m.
- **CLM-36\_-30**     **With uncoated stainless steel rope electrode and uncoated weight** for level measurement of bulk-solid materials (grains, sand, flour, cement, etc.) Shortened cable option. Electrode length from 1 m to 20 m.
- **CLM-36\_-31**     **With uncoated stainless steel rope electrode and coated dynamic anchorage** for level measurement of bulk-solid materials in higher silos. Electrode length from 1 m to 20 m.
- **CLM-36\_-32**     **With fully coated rope electrode and coated weight (rope insulation FEP, weight insulation PTFE)**, for level measurement of electrically conductive and non-conductive liquids. Electrode length from 1 m to 20 m.

# DIMENSIONAL DRAWING

**CLM-36\_-10, 11, 12**

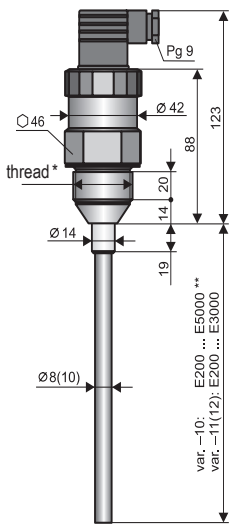

**CLM-36\_-20, 22**

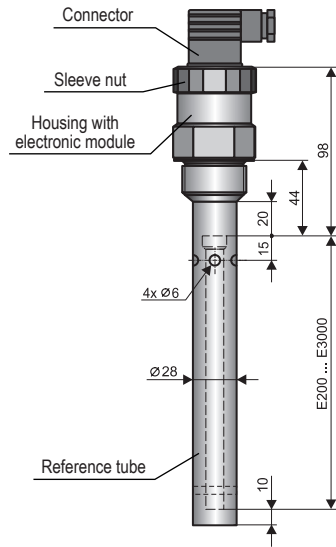

**CLM-36\_-30**

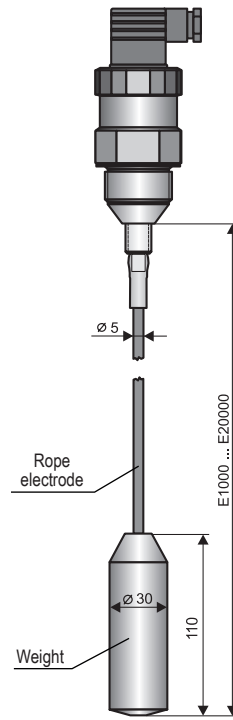

**CLM-36\_-31**

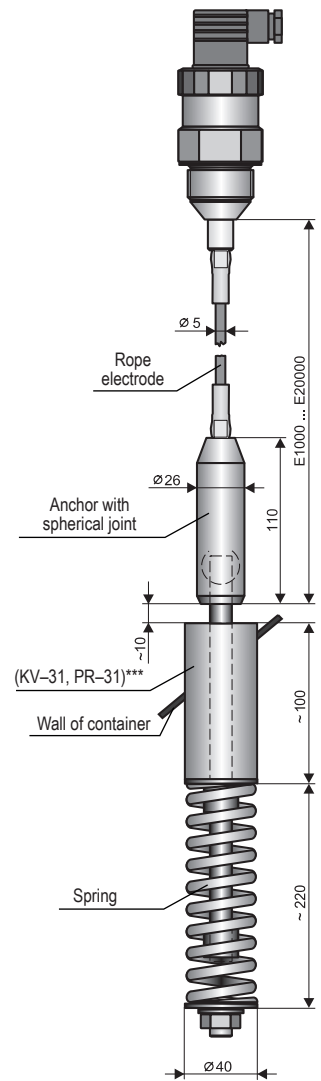

**CLM-36\_-32**

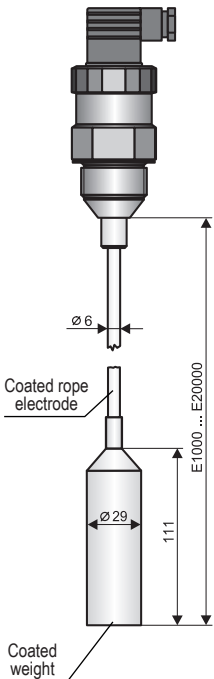

**High temperature variants  
CLM-36\_T**

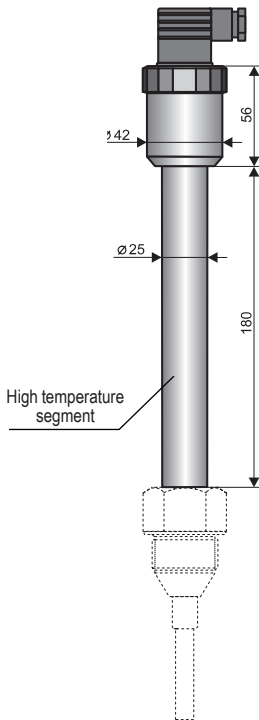

**Housing with Tri-clamp coupling**

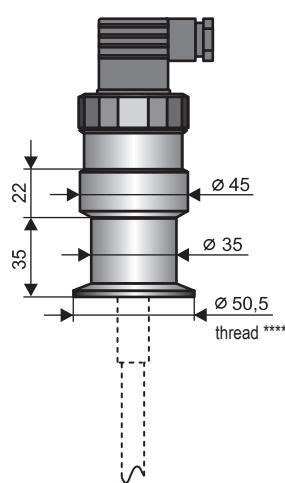

\* type threads: M36x2; G 1"

\*\* for materials with a low permittivity ( $\epsilon_r < 10$ ) the minimum electrode length is E500.

\*\*\* Anchor welding cylinder KV-31 or Dust-tight bushing PR-31 (see accessories)

\*\*\*\* type of threads: Tri-Clamp CI50 ( $\phi$  50,5 mm)

## TECHNICAL SPECIFICATIONS

TECHNICAL SPECIFICATION (variants N, NT)		
Supply voltage	CLM-36N(T)-___-I CLM-36N(T)-___-U	9 ... 36 V DC 16 ... 36 V DC
Current output		4 ... 20 mA
Voltage output		0 ... 10 V *
Power consumption (off-load)	CLM-36N(T)-___-U	approx. 8mA
Sensitivity ranges		20; 30; 50; 100; 150; 300; 500; 1000 pF
Initial capacity regulation ratio		min. 1:2
Nonlinearity		max. 1 %
Temperature error		max. 0,05% / K
Voltage error for current and voltage output		max. 0,3 $\mu$ A/V and 0,1 mV/V
Internal resistance / Electric strength (Electrode – Housing)		1 M $\Omega$ / 250 V AC
Coupling capacity / Electric strength (Housing – Supply leads)		51 nF / 250 V AC
Protection class	standard Optional (Connector GAN-DADE 7A / DAEE 7A)	IP67 (Housing), IP65 (Connector) IP67
Maximal load (serial) resistance for current output (U = 24 V)		R <sub>max</sub> = 750 $\Omega$
Minimal load resistance for voltage output		R <sub>min</sub> > 1 k $\Omega$
Maximum tensile strength of the rope electrode		1400 kg
Recommended cable		PVC 2x0,75 mm <sup>2</sup> (3x0,5 mm <sup>2</sup> )
Weight (exclude electrode)	Version N, Xi Version NT, XiT	approx. 0,5kg approx. 1kg

\*) Upon request, a different type of output terminal can be produced (e.g. 0 - 5 V)

ELECTRICAL PARAMETERS (variants Xi, XiT)	
Supply voltage	9 ... 30 V DC
Max. internal values	U <sub>i</sub> = 30 V DC; I <sub>i</sub> = 132 mA; P <sub>i</sub> = 0,99 W; C <sub>i</sub> = 370 nF; L <sub>i</sub> = 0,9 mH
Internal resistance / Electric strength (Electrode – Housing)	1 M $\Omega$ / 250 V AC
Coupling capacity / Electric strength (Housing – Supply leads)	26 nF / 500 V AC
Allowed temperature range in zone 0 (EN 50284)	-20 ... +60°C
Allowed pressure range in zone 0 (EN 50284)	0,08 ... 0,11 MPa

USED MATERIALS			
Sensor part	Variants	Standard material	Optional (on request)
Housing	All types	St. Steel W. Nr. 1.4301 (AISI 304)	St. Steel W. Nr. 1.4571 (AISI 316 Ti) St. Steel W. Nr. 2.4858 (Incoloy 825)
Insulating bushing	All types	PTFE	–
Electrode	CLM – 36_-10, 11, 12, 20, 22 CLM – 36_-30, 31, 32	St. Steel W.Nr. 1.4404 (AISI 316 L) St. Steel W.Nr. 1.4401 (AISI 316)	St. Steel W. Nr. 1.4571 (AISI 316 Ti) –
Electrode coating	CLM – 36_-12, 22, 32 CLM – 36_-11 CLM – 36_-31	FEP PFA Polyolefin (modified PE)	– – PTFE
Weight insulation	CLM – 36_-32	PTFE	–
Weight / Anchor mechanism	CLM – 36_-30, 31, 32	St. Steel W. Nr. 1.4301 (AISI 304)	–
Reference tube	CLM – 36_-20, 22	St. Steel W. Nr. 1.4301 (AISI 304)	St. Steel W. Nr. 1.4571 (AISI 316 Ti)

PROCESS CONNECTION		
Type	Size	Marking
Metric thread	M36x2	M
Pipe thread	G 1"	G
Jointless connection (Tri-Clamp)	ø 50,5 mm	CI50

## WORKING AREAS AND AREA CLASSIFICATION (EN 60079-0, EN 60079-10-1(2))

CLM – 36N	Basic performance for non-explosive atmospheres.
CLM – 36NT	High-temperature basic performance for non-explosive atmospheres.
CLM – 36Xi (10, 20, 30, 31)	Intrinsically safe explosion-proof performance for use in hazardous areas (explosive gas atmospheres or explosive atmospheres with dust) Ⓜ II 1 G Ex ia IIB T5 Ga; Ⓜ II 1 D Ex ia IIIC T83°C Da with a spark-secure power supply unit, the whole sensor zone 0 and 20.
CLM – 36Xi (11, 12, 22, 32)	Intrinsically safe explosion-proof performance for use in hazardous areas (explosive gas atmospheres) Ⓜ II 1 G Ex ia IIB T5 Ga with a spark-secure power supply unit, the whole sensor zone 0 and 20.
CLM – 36XiT (10, 20, 30, 31)	Intrinsically safe high-temperature explosion-proof performance for use in hazardous areas (explosive gas atmospheres or explosive atmospheres with dust) Ⓜ II 1/2 G Ex ia IIB T5 Ga/Gb; Ⓜ II 1/2 D Ex ia IIIC T83°C Da/Db with a spark-secure power supply unit, electrode part zone 0 and 20, head zone 1 and 21.
CLM – 36XiT (11, 12, 22, 32)	Intrinsically safe high-temperature explosion-proof performance for use in hazardous areas (explosive gas atmospheres) Ⓜ II 1/2 G Ex ia IIB T5 Ga/Gb with a spark-secure power supply unit, electrode part zone 0 and 20, head zone 1 and 21.

## TEMPERATURE DURABILITY

Variants / Performance	temperature $t_m$	temperature $t_p$	temperature $t_a$
CLM-36N-10, 20	-40°C ... +300°C	-40°C ... +85°C	-40°C ... +85°C
CLM-36N-11, 12, 22	-40°C ... +200°C	-40°C ... +85°C	-40°C ... +85°C
CLM-36N-30	-40°C ... +200°C	-40°C ... +85°C	-40°C ... +85°C
CLM-36N-31 (incl. PR-31)	-40°C ... +130°C	-40°C ... +85°C	-40°C ... +85°C
CLM-36N-31 (incl. KV-31)	-40°C ... +250°C	-40°C ... +85°C	-40°C ... +85°C
CLM-36N-32	-40°C ... +130°C	-40°C ... +85°C	-40°C ... +85°C
CLM-36Xi-10, 20	-40°C ... +200°C	-40°C ... +75°C	-40°C ... +75°C
CLM-36Xi-11, 12, 22	-40°C ... +120°C	-40°C ... +75°C	-40°C ... +75°C
CLM-36Xi-30	-40°C ... +105°C	-40°C ... +75°C	-40°C ... +75°C
CLM-36Xi-31 (incl.. PR-31)	-40°C ... +105°C	-40°C ... +75°C	-40°C ... +75°C
CLM-36Xi-31 (incl. KV-31)	-40°C ... +105°C	-40°C ... +75°C	-40°C ... +75°C
CLM-36Xi-32	-40°C ... +105°C	-40°C ... +75°C	-40°C ... +75°C
CLM-36NT-10, 20	-40°C ... +300°C	-40°C ... +200°C	-40°C ... +85°C
CLM-36NT-11, 12, 22	-40°C ... +200°C	-40°C ... +200°C	-40°C ... +85°C
CLM-36NT-30	-40°C ... +250°C	-40°C ... +130°C	-40°C ... +85°C
CLM-36NT-31 (incl. PR-31)	-40°C ... +130°C	-40°C ... +130°C	-40°C ... +85°C
CLM-36NT-31 (incl. KV-31)	-40°C ... +250°C	-40°C ... +130°C	-40°C ... +85°C
CLM-36NT-32	-40°C ... +130°C	-40°C ... +130°C	-40°C ... +85°C
CLM-36XiT-10, 20	-40°C ... +200°C	-40°C ... +200°C	-40°C ... +75°C
CLM-36XiT-11, 12, 22	-40°C ... +120°C	-40°C ... +200°C	-40°C ... +75°C
CLM-36XiT-30	-40°C ... +250°C	-40°C ... +130°C	-40°C ... +75°C
CLM-36XiT-31 (incl. PR-31)	-40°C ... +130°C	-40°C ... +130°C	-40°C ... +75°C
CLM-36XiT-31 (incl. KV-31)	-40°C ... +250°C	-40°C ... +130°C	-40°C ... +75°C
CLM-36XiT-32	-40°C ... +130°C	-40°C ... +130°C	-40°C ... +75°C

Note: For correct function of the level meter must not be exceeded any of the temperature range ( $t_p$ ,  $t_m$  or  $t_a$ )

1) The temperatures are clearly explained on Fig.

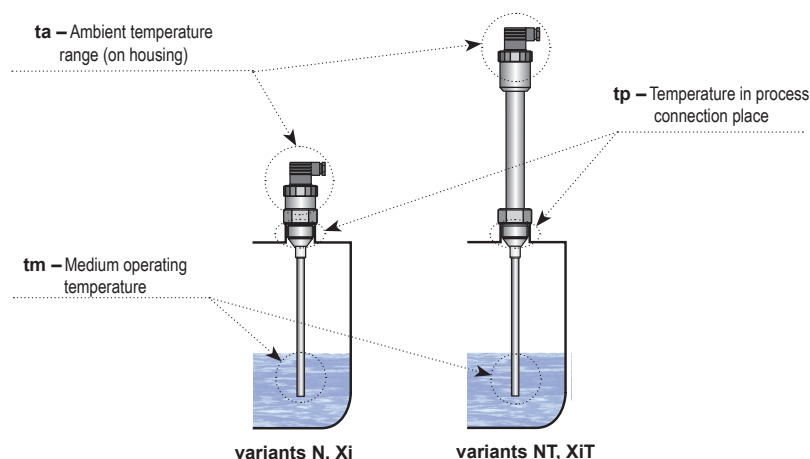

## PRESSURE DURABILITY

Variants / Performance	Maximal operation pressure for temperature tp				
	Up to 30°C	Up to 85°C	Up to 130°C	Up to 160°C	Up to 200°C
CLM-36N-10, 20	7 MPa	5 MPa	–	–	–
CLM-36N-11, 12, 22	4 MPa	2 MPa	–	–	–
CLM-36N-30	7 MPa	5 MPa	–	–	–
CLM-36N-31	–	–	–	–	–
CLM-36N-32	1 MPa	0,5 MPa	–	–	–
CLM-36Xi-10, 20	7 MPa	5 MPa	–	–	–
CLM-36Xi-11, 12, 22	4 MPa	2 MPa	–	–	–
CLM-36Xi-30	7 MPa	5 MPa	–	–	–
CLM-36Xi-31	–	–	–	–	–
CLM-36Xi-32	1 MPa	0,5 MPa	–	–	–
CLM-36NT-10, 20	7 MPa	5 MPa	3 MPa	2 MPa	1 MPa
CLM-36NT-11, 12, 22	6 MPa	4 MPa	2 MPa	1,5 MPa	0,3 MPa
CLM-36NT-30	7 MPa	5 MPa	3 MPa	–	–
CLM-36NT-31	–	–	–	–	–
CLM-36NT-32	1 MPa	0,5 MPa	0,1 MPa	–	–
CLM-36XiT-10, 20	7 MPa	5 MPa	3 MPa	2 MPa	1 MPa
CLM-36XiT-11, 12, 22	6 MPa	4 MPa	2 MPa	1,5 MPa	0,3 MPa
CLM-36XiT-30	7 MPa	5 MPa	3 MPa	–	–
CLM-36XiT-31	–	–	–	–	–
CLM-36XiT-32	1 MPa	0,5 MPa	0,1 MPa	–	–

## INFLUENCE OF THE TANK SHAPE ON A LINEARITY OF MEASUREMENT

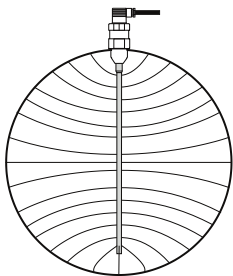

In a curved tanks (most frequently horizontal cylinder) capacity change during measuring of electrically non-conductive material is non-linear.

**FOR TYPE: CLM-36\_-10, 11, 12  
CLM-36\_-30, 31, 32**

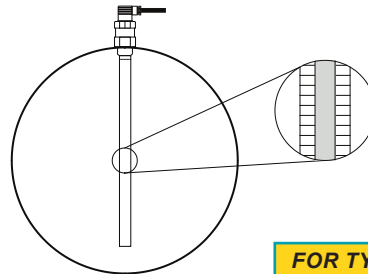

Linearity is done by reference tube (CLM – 36\_-20, 22).

**FOR TYPE: CLM-36\_-20, 22**

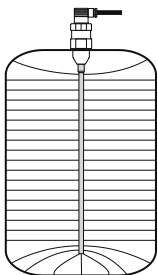

In the tank with straight wall (for example vertical cylinder) and with the sensor placed parallelly with the wall capacity change is linear.

**FOR TYPE: all types**

## RANGE OF APPLICATION

Capacitive level meters are suitable for continuous level measurement of liquid and bulk-solid materials. CLMs are resistant to any changes in the atmosphere above the surface (vacuum, pressure, vapours, dust).

## ELECTRICAL CONNECTION

The level meter is designed to be connected to supply unit or to controller through a cable with the outer diameter of  $6 \div 8$  mm (recommended cross-section of cores  $0.5 \div 0.75$  mm<sup>2</sup>) by means of connector which is standard part of CLM level meter. The diagram and the inside view of the connector are shown in the figures. Disassemblable connector IP67 with a 5m long PVC cable can be supplied as an above-standard accessory.

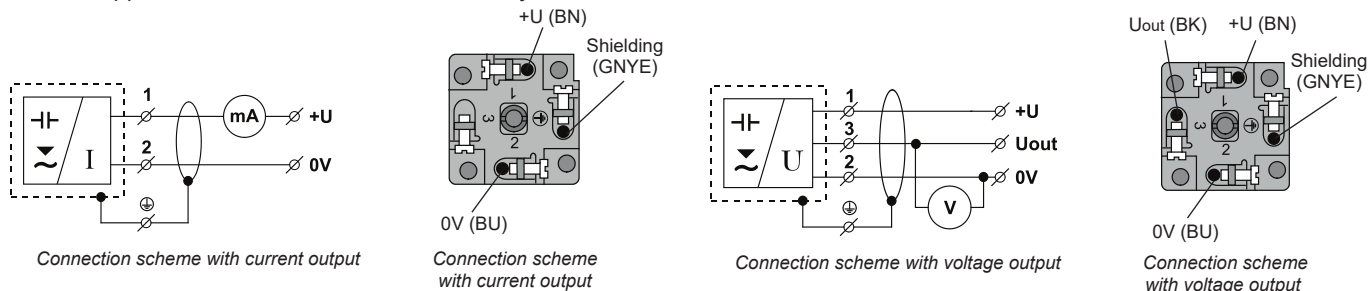

## SETTINGS

The adjustment of level meter is by DIP switches and two trimmers 4 mA and 20 mA (to set min. and max. level). These adjustment elements are placed under outlet nut of level meter. For detailed information please read at the instructions.

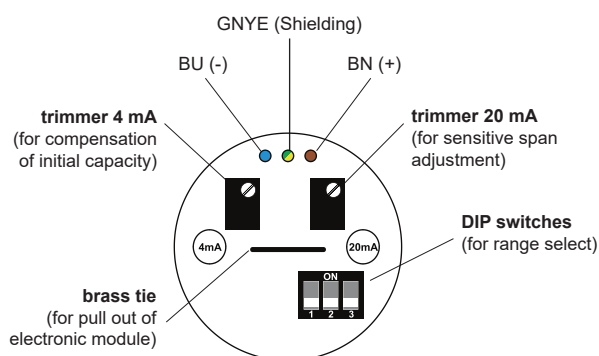

The top view on the internal electronic module with current output (variant -I)

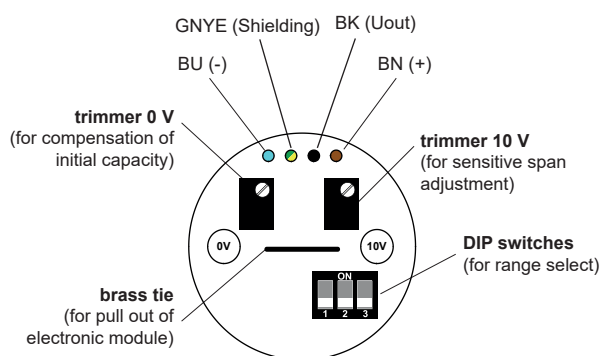

The top view on the internal electronic module with voltage output (variant -U)

### Legend:

GNYE – green-yellow      BK – black  
 BN – brown                      BU – blue

# ORDER CODE

## PRODUCT

CLM-36

### PERFORMANCE

**N** non-explosive areas

**NT** high temperature performance

**Xi**  for explosive environments

**XiT**  high-temperature conf. for explosive environments

### TYPE AND PERFORMANCE OF ELECTRODE

**10** uncoated St. steel rod electrode, length 0,2 / 0,5 ... 5 m

**11** fully coated St. steel rod electrode (PFA), length 0,2 ... 3 m

**12** fully coated St. steel rod electrode (FEP), length 0,2 ... 3 m

**20** uncoated St. steel rod electrode with reference tube, length 0,2 ... 3 m

**22** coated St. steel rod electrode with reference tube (FEP), length 0,2 ... 3 m

**30** uncoated St. steel rope electrode, length 1 ... 20 m

**31** uncoated St. steel rope electrode with anchor, length 1 ... 20 m

**32** suspension electrode with insulated cable (FEP) and insulated ballast (PTFE), length 1 ... 20 m

### PROCESS CONNECTION

**M** thread M36x2

**G** thread G1"

**CI50** Tri-clamp (ø 50,5 mm)

### OUTPUT TYPE

**I** current (4 ... 20 mA)

**U** voltage (0 ... 10 V)

### LENGTH OF ELECTRODE

**E** electrode length in mm

### CABLE

**K** cable length in m

CLM-36 N - 10 - G - I - E1000 K 5

EXAMPLE OF CODING

## CORRECT SPECIFICATION EXAMPLES

CLM-36N-10-G-I E1000

(N) normal (for non-explosive areas); (10) uncoated St. steel rod electrode; (G) process connection thread G1"; (I) current (4 ... 20 mA); (E1000) length electrode 1000 mm

CLM-36XiT-30-G-I E9750

(XiT) high-temperature conf. for explosive environments; (30) uncoated St. steel rope electrode; (G) process connection thread G1"; (I) current (4 ... 20 mA); (E9750) length electrode 9750 mm.

## ACCESSORIES

**standard** (included in the level meter price)

- 1x of seal, other seals are on request (PTFE, Al, etc.) \*
- 1x connector socket
- 1x screwdriver for adjustment (each 5 pcs)

**optional** – for a surcharge (see catalogue sheet of accessories)

- Connector with protection class IP67 (GAN-DADE 7A) with 5 m cable (current output)
- Connector with protection class IP67 (GAN-DAAE 7A) with 5 m cable (voltage output)
- Steel welding flange ON-36x2
- St. steel welding flange NN-36x2
- St. steel fixing nut UM-36x2
- Anchor welding cylinder KV-31 (only CLM-36-31)
- Dust-tight bushing PR-31(only CLM-36-31)

\* Pressure resistance - see the table in the accessories datasheet in the "seals and gaskets".

## SAFETY, PROTECTIONS, COMPATIBILITY AND EXPLOSION PROOF

Level meter is equipped with protection against electric shock on the electrode, reverse polarity, output current overload, short circuit and against current overload on output.

Protection against dangerous contact is provided by low safety voltage according to 33 2000-4-41. Electromagnetic compatibility is provided by conformity with standards EN 55022 / B, EN 61326-1, EN 61000-4-2 to -6.

Explosion proof CLM-36Xi(XiT) is provided by conformity with standards EN 60079-0:2013+A11:2014, EN 60079-11:2012.

Explosion proof CLM-36Xi(XiT) is verified FTZÚ – AO 210 Ostrava – Radvanice: FTZÚ 02 ATEX 0235X.

A declaration of conformity was issued for this device in the wording of Act No. 90/2016 Coll., as amended. Supplied electrical equipment matches the requirements of valid European directives for safety and electromagnetic compatibility.

### **Special conditions for safe use of variants CLM-36Xi**

If the apparatus is used as device of Group II and with using of an approved power supply device, which output parameters comply with required input parameters, it is necessary to have an galvanic separation.

When used in zone 0 the present explosive atmosphere of air mixture and gases, vapours of mists must comply with:  $-40^{\circ}\text{C} \leq T_{\text{amb}} \leq 60^{\circ}\text{C}$ ;  $0,08 \text{ Mpa} \leq p \leq 0,11 \text{ Mpa}$ .

Design CLM-36Xi can be used in zone 0 or zone 20. With design CLM-36XiT can be used in zone 0 and zone 20 only electrode part an head with electronics can be used only in zone 1 or zone 21.

Ambient temperature:  $T_{\text{amb}} = -40^{\circ}\text{C}$  to  $+75^{\circ}\text{C}$

Temperature of measured medium according to design variant:

bar non-insulated electrode  $-40^{\circ}\text{C}$  to  $+200^{\circ}\text{C}$

bar insulated electrode  $-40^{\circ}\text{C}$  to  $+120^{\circ}\text{C}$

cable with insulated cable  $-40^{\circ}\text{C}$  to  $+105^{\circ}\text{C}$

Maximum temperature of electrodes is equal to temperature of measured medium.

Maximum input parameters:  $U_i = 30 \text{ V}$ ;  $I_i = 132 \text{ mA}$ ;  $P_i = 0,99 \text{ W}$ ;  $C_i = 370 \text{ nF}$ ;  $L_i = 0,9 \text{ mH}$

version 05/2020

CLM-36-dat-8.7



Dinel, s.r.o.  
U Tescomy 249  
760 01 Zlín, Czech Republic

Phone: +420 577 002 003

sale@dinel.cz  
www.dinel.cz