



CAPACITIVE LEVEL SENSORS DLS-27



CONTENTS

1. Basic description	3
2. Variants of sensors	4
3. Dimensional drawing.....	5
5. Mechanical mounting	6
4. Installation and putting into operation	6
6. Range of application and installation of individual variants.....	12
7. Electrical connection	13
8. Settings	15
9. Function and status indication.....	16
10. Order code	17
11. Correct specification examples	17
12. Accessories.....	18
13. Safety, protections, compatibility and explosion proof.....	18
14. Use, manipulation and maintenance.....	19
15. General, conditions and warranty	20
16. Marking of labels.....	20
17. Technical specifications.....	23
18. Packings, shipping and storage	26
19. FAQ (Frequently asked questions)	27

USED SYMBOLS

To ensure maximum safety of control processes, we have defined the following safety instructions and information. Each instruction is labelled with the appropriate pictogram.



Alert, warning, danger

This symbol informs you about particularly important instructions for installation and operation of equipment or dangerous situations that may occur during the installation and operation. Not observing these instructions may cause disturbance, damage or destruction of equipment or may cause injury.



Information

This symbol indicates particularly important characteristics of the device.



Note

This symbol indicates helpful additional information.

SAFETY



All operations described in this instruction manual have to be carried out by trained personnel or by an accredited person only. Warranty and post warranty service must be exclusively carried out by the manufacturer.

Improper use, installation or set-up of the sensor can lead to crashes in the application.

The manufacturer is not responsible for improper use, loss of work caused by either direct or indirect damage, and for expenses incurred at the time of installation or during the period of use of the level sensors.

1. BASIC DESCRIPTION

Capacitive level sensors DLS® are designed for limit sensing of the level of liquid and bulk solids in tanks, sumps, tubes or, hoppers, silos, etc. The sensors are manufactured in several modifications of sensing electrodes (rod and rope). The electrodes can be given an insulating coating, a useful feature in case of adhesive, aggressive or conductive media sensing. Rod electrodes are also available in a version with reference tube for measuring fluids in tanks made from non-conductive material.

Sensors are manufactured in the following configurations: **N** – for non-explosive areas, **Xd** – For use in flammable dust atmospheres; **Xi** – Explosion proof – intrinsically safe for hazardous (explosive) areas and **XiM** – Explosion proof – intrinsically safe for use in mines with methane or flammable dust presence danger (see technical specifications). There are high temperature performance **NT**, **XiT**, **XiMT** available and various types of process connection (metric and pipe thread, jointless connection Tri-clamp).

2. VARIANTS OF SENSORS

- **DLS-27_-10 Uncoated short bar electrode** for sensing non-adhesive bulk solids (sand, sugar) and non-conductive liquids (petroleum products, oils), horizontal mounting.
Electrode length 50 mm or 100 mm.
- **DLS-27_-11 Fully coated short bar electrode**, for sensing conductive liquids (water).
Horizontal mounting into tanks and tubes.
Electrode length 30 mm.
- **DLS-27_-20 Semi-coated rod electrode** for sensing slightly adhesive bulk solids (cement, flour) and non-conductive liquids (plant oils), horizontal, slant or vertical mounting.
Electrode length from 0.1 m to 1 m.
- **DLS-27_-21 Fully coated rod electrode (FEP insulation)** for sensing conductive liquids (water solutions, water), adhesive and aggressive materials, horizontal or vertical mounting.
Electrode length from 0.1 m to 1 m.
- **DLS-27_-22 Fully coated rod electrode (PFA insulation) with enhanced resistance**, for sensing aggressive conductive liquids and materials. Horizontal or vertical mounting.
Electrode length from 0,1 m ... 1 m.
- **DLS-27_-30 Dismountable uncoated rod electrode** for sensing bulk solids and conductive or non-conductive liquids. Vertical or horizontal slant mounting.
Electrode length 0.1 m ... 3 m.
- **DLS-27_-31 Fully coated rod electrode**, for sensing aggressive conductive liquids (water, various chemicals). Vertical mounting.
Electrode length from 0.1 m to 2 m.
- **DLS-27_-40 Uncoated rope electrode and weight**, for general purpose use in deeper silos (bulk solids sensing – sand, gravel, cement) or sumps (sensing liquids).
Vertical mounting.
Electrode length from 1 m to 6 m.

3. DIMENSIONAL DRAWING

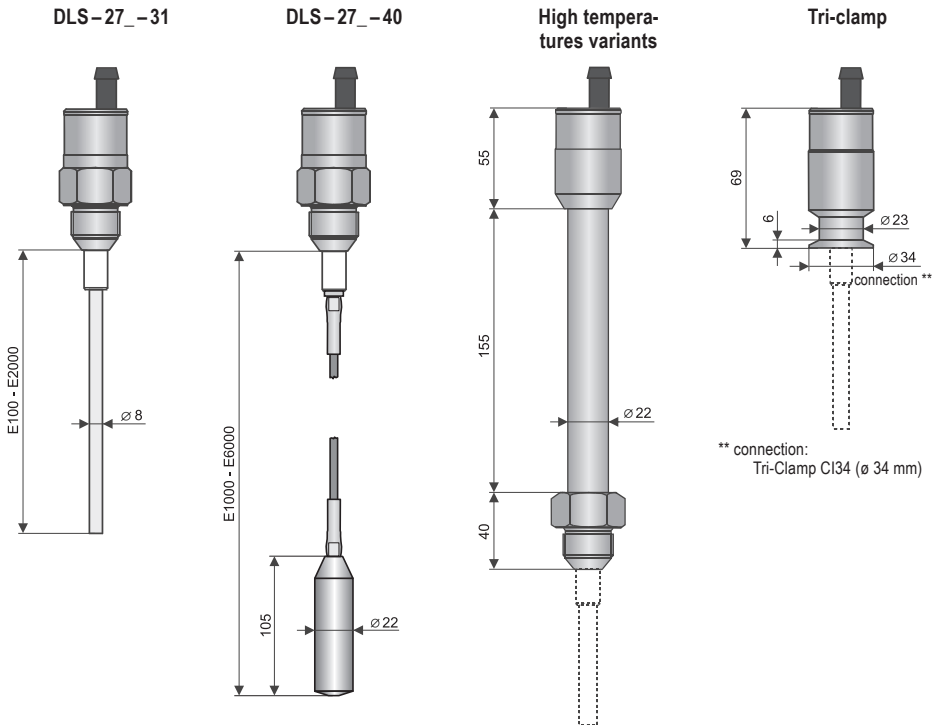
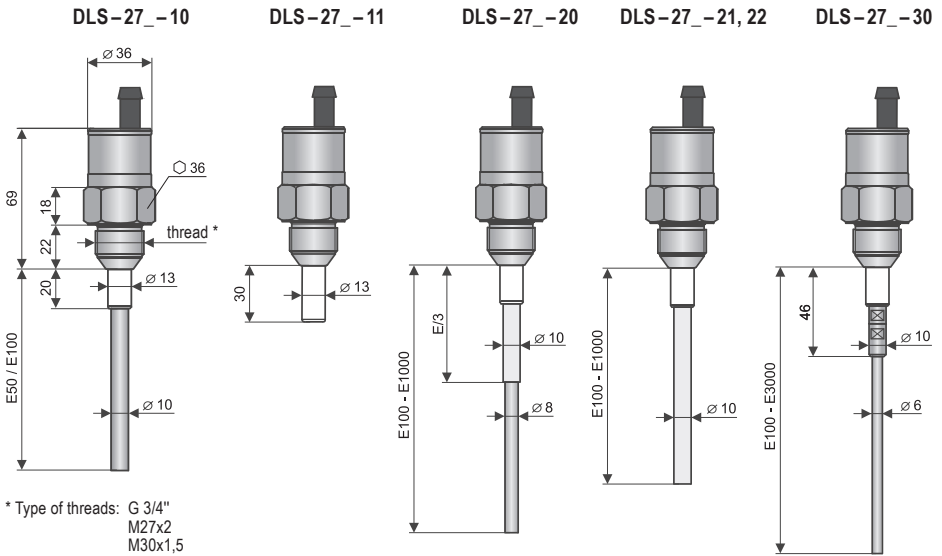

Variants "B" with cable outlets

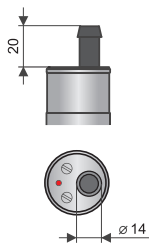

Variants "C" with connector

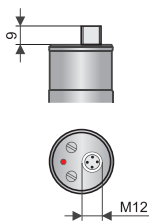

Variants "D" with cable outlets

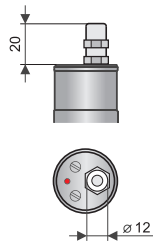

4. INSTALLATION AND PUTTING INTO OPERATION

Please follow next 3 steps:

- **MECHANICAL MOUNTING - SEE CHAPTER 5**
- **ELECTRICAL CONNECTION - SEE CHAPTER 7**
- **SETTINGS - SEE CHAPTER 8**

5. MECHANICAL MOUNTING

BASIC INFORMATION

- DLS® level sensors can be fixed in a vertical, horizontal or slanted position into the wall of a vessel, storage tank or on a fixation console in a sump by screwing into the welding flange, using a fixing nut or TriClamp® process connection.
- Basic application recommendations are mentioned below.



During assembly into the metal tank or the storage tank, it is not necessary to separately ground the base of the level sensor. In case of installation in concrete sumps or silos, it is appropriate to install the level sensor onto a metallic auxiliary construction (console, lid, etc.), and then connect to a metallic, constantly submerged object, or with steel with steel reinforcements in concrete (armouring).

In the case of the reading of an aggressive medium, we recommend that the producer be consulted



If the sensors are fitted with protective caps at the ends of the electrodes, remove the caps before commissioning.

VERTICAL MOUNTING

FOR TYPE: All vertically mounted sensors

In case of **vertical mounting**, sensors can be mounted into open, closed and pressurized tanks. The stated distances relate to the electrode length (longer electrode).

$$c \geq 10 + \frac{E}{50} \quad d \geq 40 + \frac{E}{40} \quad k \geq 20 + \frac{E}{20}$$

E – Electrode length in mm

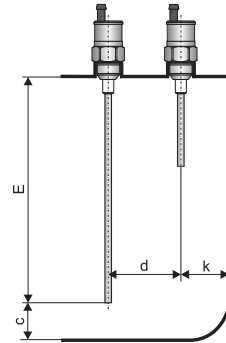

Fig. 1: Vertical mounting

CORRECT AND INCORRECT INSTALLATION WITH A LONG TUBE

FOR TYPE: All from side mounted sensors

In the case of **side wall mounting**, it is necessary to avoid long fitting tubes, where sensed medium could accumulate (fig. on right). We recommend mounting the sensor so that the whole sensing electrode and insulation is inside the storage tank (Figure 2 – on left).

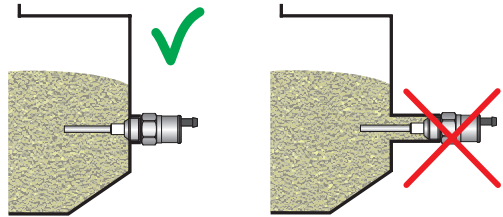

Fig. 2: Correct and incorrect installation with a long tube

CORRECT AND INCORRECT INSTALLATION INTO STORAGE TANK SIDE WALL

FOR TYPE: All side mounted sensors

In case of **side wall mounting** (Fig. 3), place the sensor outside the flow of bulk solids or liquids.

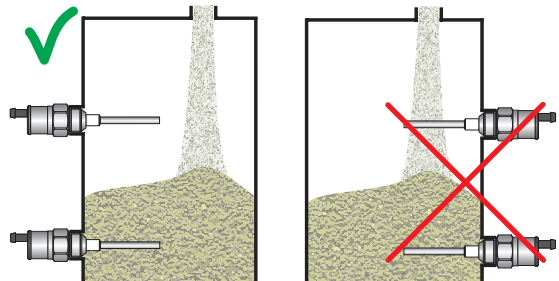

Fig. 3: Correct and incorrect installation into storage tank side wall

PROTECTIVE ROOF MOUNTING

FOR TYPE: DLS-27_-10 and DLS-27_-20

Protective roof cover is recommended to prevent mechanical damage of the sensor electrode when **vertical movement of material** could damage the sensing electrode (abrasive materials, bulk-solid materials forming blocks, piece goods).

$$s \approx \frac{4}{3}E \quad p \approx \frac{3}{4}E \quad m \approx \frac{2}{3}E$$

E- Electrode length in mm

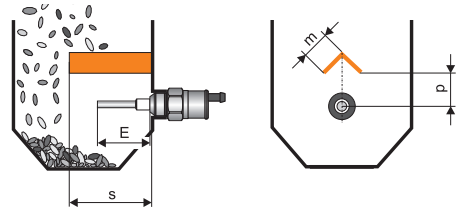

Fig. 4: Protective roof mounting

SLANT WALL MOUNTING

FOR TYPE: DLS-27_-10 and DLS-27_-20

In the case of **slant wall mounting** it is necessary to eliminate **fitting tubes**, thereby reducing medium sedimentation. The wrong example of mounting is shown in Figure 5 on the left. The appropriate mounting on the auxiliary vertical plate is shown in the middle. In some cases the variant is allowed as shown in Fig. 5 on the right. But this is recommended only for measuring bulk-solid materials by a sensor of the DLS-27_-10 type, which do not mechanically damage the electrode and do not form separate blocks.

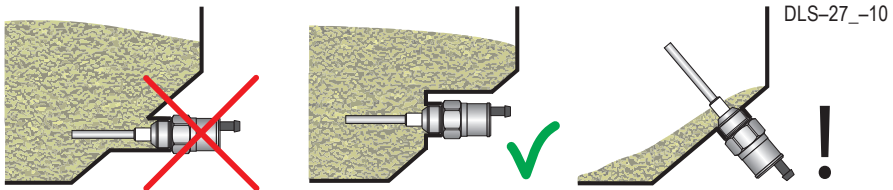

Fig. 5: Slant wall mounting

BENDING OF THE ELECTRODE END TO SENSE UNKNOWN FLUIDS

FOR TYPE: DLS-27_-30

In case of **vertical installation** for sensing the level of **unknown (conductive and non-conductive) liquids** in tanks or sumps, it is appropriate to bend the electrode into a right angle. This will increase the local sensitivity and accuracy of sensing the level at the spot of the bend.

When weather conditions (wind, rain, snow) clearly influence the electrode (open sumps), we recommend using types with an insulated electrode (DLS-27_-21, 31).

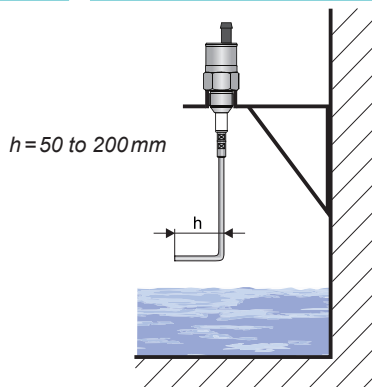

Fig. 6: Bending of the electrode end to sense unknown fluids

AUXILIARY ELECTRODE IN NON-CONDUCTIVE TANKS

FOR TYPE: DLS-27_-20, 21, 22,
30, 31

In the case of the application of the sensor in an **electrically non-conductive** (e.g. plastic) vessel in the vertical position, then for the correct function, it is recommended to connect the housing of the level sensor with an **auxiliary electrode**. The auxiliary electrode can consist of a bar which is permanently dipped into the medium (e.g. conductive probe CNP-18), or can be use the auxiliary plate electrode (PDE-27), where the first part has thread for install of the sensor and the second part is installed from the side on the wall into the area for the expected switching of the level sensor. Both parts of PDE-27 are connected by steel wire. The area of the plate auxiliary electrode is a minimum 200 cm². For non-conductive liquids, the only variation possible is with the plate auxiliary electrode and in this case it is necessary to place the level sensor to prevent the movement of electrodes and the axis is at the distance of $l_{\max} = E1/10$, $l_{\min} = 20$ mm.

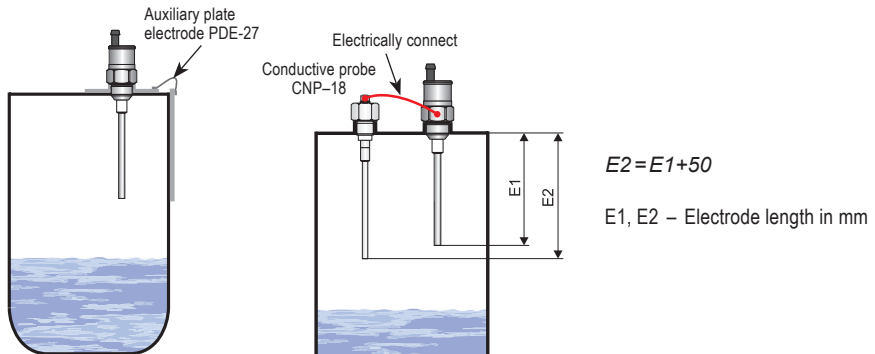

Fig. 7: Auxiliary electrode in non-conductive tanks

SOLAR RADIATION SHIELDING COVER

FOR TYPE: All type

The level meter must not be installed in locations exposed to **direct solar radiation** and must be protected against the effects of weather. In the event that installation in a location with direct solar radiation is unavoidable, it is necessary to install a **shielding cover** above the level meter.

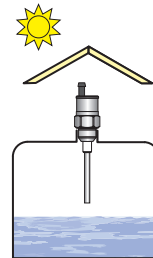

Fig. 8: Solar radiation shielding cover

BYPASS MEASURING TUBE

FOR TYPE: DLS-27_-20, 21, 22, 30, 31

Mounting in a **bypass measuring tube**. We recommend upholding the tube diameter.

$$b \geq 40 + \frac{E}{20}$$

E- Electrode length in mm

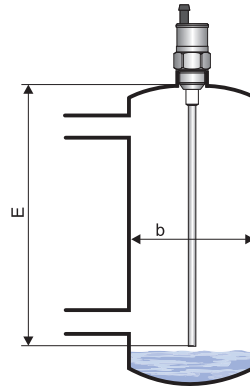

Fig. 9: Bypass measuring tube

PROTECTIVE HOSE INSTALL

FOR TYPE: All sensors with cable outlets

If the sensor is placed vertically in an outdoor environment or in the event of increased mechanical stress, it is recommended to install a 15/10 mm PVC protective hose on the "B" cable.

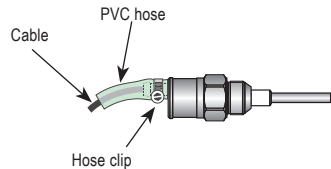

Fig. 10: Protective hose install

SENSOR MOUNTING IN A TUBE

FOR TYPE: DLS-27_-10, 11, 21, 22

In the case of **mounting in the pipe** it is necessary to provide the minimum distance of the inner walls from the electrode at 5 mm. In some cases (sticky liquids, low permittivity liquids) it is better to mount the sensor into a pipe bend.

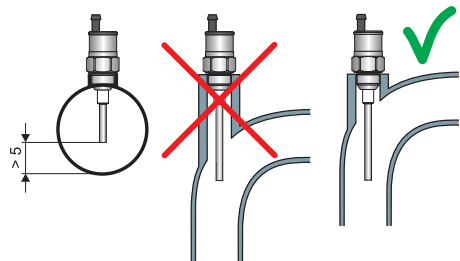

Fig. 11: Sensor mounting in a tube

TWO-STATE LEVEL REGULATION BY HYSTERESIS SETTING

FOR TYPE: DLS-27_-20, 21, 22, 30, 31

In the case of **vertical mounting** it is possible to use hysteresis setting for simple **two state regulation** (pump control). The height of the controlled level is done by sensitivity setting, the gap between the min. and max. is defined by hysteresis.

E- Electrode length in mm

$$a \approx \frac{1}{10} E \div \frac{1}{3} E$$

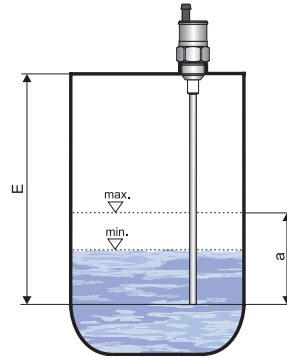

Fig. 12: Two-state level regulation by hysteresis setting

LONG FITTING TUBES IN VERTICAL MOUNTING

FOR TYPE: All vertically mounted sensors

In the case of **vertical mounting** especially on existing tanks, it is necessary to select the pipe length **as short as possible** to avoid vapour condensation, or sedimentation of impurities. A similar situation occurs when the sensing electrode goes through the concrete ceiling of the silo. The hole diameter should be at least 50 mm (based on ceiling thickness).

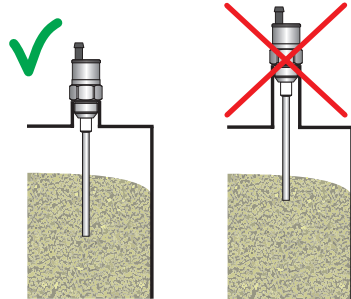

Fig. 13: Long fitting tubes in vertical mounting

6. RANGE OF APPLICATION AND INSTALLATION OF INDIVIDUAL VARIANTS

DLS-27_-10

Produced in two versions – with 50 mm or 100 mm electrode. The shorter version (E50) is suitable for clean non-conductive liquids level sensing (oils, diesel, petrol, etc.). The longer version (E100) is designed for non-adhesive bulk solids or non-adhesive powder materials (plastic granulates, sand, sugar, grains, detergents, etc.) and other slightly impure, non-conductive liquids (lubricants, plant oils). The sensor is specified to be mounted directly into a vessel or storage tank wall (best by horizontal position) by means of welding flanges or stainless steel fixing nuts. In case of level sensing of low-permittivity media in non-metal storage tanks, we recommend mounting the sensor on an auxiliary metal-plate electrode with min. area of 200 cm².

DLS-27_-11

Specified for level sensing of conductive liquids (water and water solutions). It can be used to identify the boundary between fluids with differing permittivity (e.g. water – oil). The sensor is mounted directly into the side wall of the vessel or in a pipe (horizontal position) by means of a standard steel or stainless steel welding flange.

DLS-27_-20

Designed for limit level detection of bulk solids with low specific weight and permittivity (cement, hydrated lime, flour), and for materials expected to have changing properties (fly ash, sawdust, feed mixtures, etc.). It is possible to use it for sensing non-conductive liquids containing a small amount of water (up to 2%) or other impurities (plant oils, liquid propane, etc.). The sensor is mounted directly into the wall of a vessel or storage tank using steel welding flanges or fixing nuts horizontally, slanted from the side or vertically. It is recommended to mount a sensor with an electrode longer than 300 mm only in the vertical position. Hollow spaces should be minimized between the electrode and the wall where the sensed material can accumulate (see application notes). In non-metal storage tanks, we recommend mounting the sensor on an auxiliary metal-plate electrode with min. area of 400 cm².

DLS-27_-21, 22

Specified for conductive liquids level sensing (water, water solutions, mud, etc.). It reacts to partial or full immersion of the electrode (depending on the adjusted sensitivity). The lower the sensitivity, the higher the sensor's resistance to contaminants and clinging remnants of material. The sensor with electrode length of up to 200 mm can be desensitized to complete water immersion, so it can be operated in the horizontal position. The sensor can be operated in the vertical position with any length up to 1 m. The sensor is mounted directly into the wall of the tank in horizontal or vertical position by applying a steel or stainless steel welding flange. For variant "22", the material PFA is used to insulate the electrode.

DLS-27_-30

Designed for sensing conductive and non-conductive liquids and bulk solids. It is not recommended to install the sensor into closed vessels (storage tanks) where intensive water vapour condensation occurs. The sensor reacts to electrically conductive liquids just by touch of the end of electrode. To react to a non-conductive liquid (bulk solid), it is necessary to have 5 + 20% immersion of the electrode according to the sensor's adjusted sensitivity and permittivity of the sensed material. The sensor is mounted directly into a tank, hopper or sump in slant or vertical position by means of welding flange or stainless steel fixing nut. In non-metal storage tanks, we recommend mounting the sensor on an auxiliary metal-plate electrode with min. area of 500 cm².

DLS-27 -31

Designed for limit level detection of conductive liquids (water and solutions of various chemicals). It is possible to place the sensor electrode into closed vessels (storage tanks), open canals and sumps. The sensor reacts to the conductive fluid level after $2 \div 20\%$ immersion of the electrode based on the sensor's set sensitivity. The sensor is mounted vertically directly into a vessel, tank or open (concrete, plastic) sumps by means of welding flanges or fixing nuts. When installing the sensor into open sumps, it is necessary to secure conductive connection of the sensor housing with the sensed liquid. It is possible to use a metal structure, armouring or another auxiliary electrode. If you must sense an aggressive medium in a closed plastic container, contact the manufacturer.

DLS-27 -40

For sensing conductive and non-conductive liquids and bulk solids at greater depths (sewerage sumps, shafts, wells, cement storage tanks, sand, gravel, etc.). It is not appropriate to place the sensor electrode into closed containers (storage tanks) where intensive condensation of water vapour occurs. The sensor reacts to electrically conductive liquids just by touch of the end of electrode. To react to non-conductive liquid or bulk solid, a $5 \div 20\%$ immersion into the material is necessary based on the sensitivity set on the sensor and the permittivity of the sensed material. The sensor is mounted vertically directly into the wall of a storage tank or sump. For open (concrete) sumps, it can be mounted on an auxiliary metal structure conductively connected with the sensed material. For mounting, you can use supplied welding flanges or fixing nuts..

7. ELECTRICAL CONNECTION

Sensor with NPN or PNP output is allowed to lead only by resistive or inductive lead. Positive supply voltage (+U) is connected to the brown conductor BN (1), negative (0V) to the blue conductor BU (3) and the leads (only NPN or PNP type of output) to the black conductor BK (4). The capacity loads and low resistance loads (bulb) is evaluated by the sensor as short circuit.

Version Xd is manufacture only with fixing cable (variants "D" with cable outlets). The end of this cable must be in terminal box with protection class IP6x.

For "B" and "D" variants with the fixed cable, the individual colour cores of the connecting cable are connected to the respective terminals of the related equipment (supply unit) see Fig. 14 to 16.

For "C" variant with the connector, the cable can be supplied with the sensor (length 2 or 5 m), fitted with the pressed connector socket or dismountable connector socket without the cable (see accessories), the connector is not part of the sensor. In this case the cable is connected to the inside pins of the socket according to Fig. 17.

The sensor with related equipment is interconnected by a suitable three-core (N and Xd variations) or two-core (Xi, XiT, XiM, XiMT variations) cable. The length of the cable for the Xi, XiT, XiM, XiMT variations must be selected with respect to the maximum permitted parameters (usually inductance and capacity) of the outside intrinsically safe circuit of supply units (NSSU, NDSU, NLCU).

If using a dismountable connector socket, the outside diameter of the cable is a maximum of 6 mm.

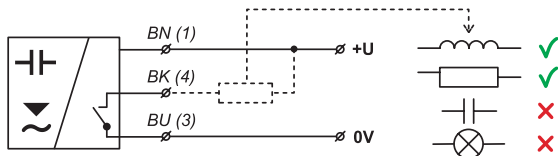

Fig. 14: NPN output type sensor connection (configuration N, NT, Xd)

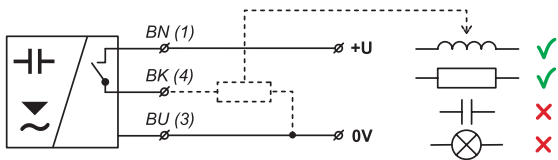

Fig. 15: PNP output type sensor connection (configuration N, NT, Xd)

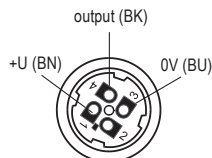

Fig. 17: Inside of the connector socket

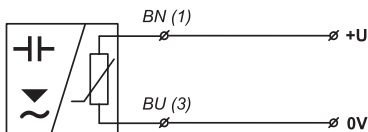

Fig. 16: Connection of a sensor with a NAMUR type output (configuration Xi, XiM, XiT, XiMT)

Legend:

- (1,...) – numbers of terminals inside the connector socket
- BK – Black
- BN – Brown
- BU – Blue



Electrical connection can only be made when de-energized!

The source of the power voltage must comprise of a stabilised safe low power source with galvanic separation. In the event that a switch-mode power supply is used, it is essential that its construction effectively suppresses common mode interference on the secondary side. In the event that the switch-mode power supply is equipped with a PE safety terminal, it must be unconditionally grounded! Spark-safe devices type DLS-27Xi(XiT, XiM, XiMT) must be powered from a spark-safe power source meeting the above-mentioned requirements.



Due to the possible occurrence of an electrostatic charge on the non-conductive parts of the sensor, it is necessary to ground all sensors intended for use in environments with an explosion hazard DLS-27Xi(XiT, XiM, XiMT) and DLS-27Xd. This can be performed by grounding el. conductive tanks or el. conductive tank lids, and in the case of el. non-conductive tanks using and grounding an auxiliary plate electrode PDE-27.

In the event that the level meter (sensor) is installed in an outdoor environment at a distance greater than 20 m from the outdoor switchboard, or from an enclosed building, it is necessary to supplement the electrical cable leading to the level meter (sensor) with suitable overvoltage protection.

In the event of strong ambient electromagnetic interference, paralleling of conductors with power distribution, or for distribution to distances over 30 m, we recommend using a shielded cable and grounding the shielding on the side of the power source.

8. SETTINGS

The sensitivity and hysteresis of the level sensor are set by trimmers "S" and "H" located under the left cover screw on the rear side.

The basic sensitivity and hysteresis is factory adjusted and is suitable for most applications.

The sensitivity is set by trimmer "S" located under the left cover screw on the rear side. Clockwise turning makes the sensitivity lower, reverse direction turning makes the sensitivity higher.

If the sensed medium is at your disposal before setting into service it is useful to provide individual setting as follows. In this way it is possible to achieve resistance against sediments.

1. The sensor is activated by immersion (by pouring, by flooding) the whole electrode or its part into the sensed media. By activating the sensor changes its status (LED lights up or goes out).
2. Reduce the sensitivity (by turning the trimmer "S" to the right) until the sensor just stops responding to this activation (immersion in the media). The LED indication is now in the same state as before activation.
3. From this point, turn the "S" trimmer 0.5 to 1 turn (depending on the type and length of the electrode) to the left. The sensor changes the status again and reacts to the activation (flooding) again.
4. Verify the function by a re-activation of the sensor and watch the sensor behavior.

If the medium is not available in advance, it is possible to use the basic setting from the producer and after some time of operation (after sedimentation of dirt) to make any correction. However, it is always necessary to know what the permittivity of the material is and to adapt the setting on the sensor. In the "Sensitivity characteristics" table it is stated for each type, where the change of capacity corresponds to the 1 rotation. A definite guide can be the fact that the flooding of the electrode in the length of 100 mm into the material with relative permeability $\epsilon_r = 2$ will cause a change in the capacity about 1.5 to 2 pF (according to the type of electrode).

The hysteresis (position of the minimum and maximum level) can be changed by turning trimmer "H" located under the right cover screw on the rear side. Clockwise turning makes the hysteresis higher, reverse direction turning makes it lower. The lower the hysteresis is, the higher sensitivity is possible to obtain, but the resistance against various disturbances get worse. For usual applications is optimal hysteresis from $\frac{1}{4}$ to $\frac{3}{4}$ rotation of sensitivity trimmer.

After setting, it is necessary to properly tighten cover screws.

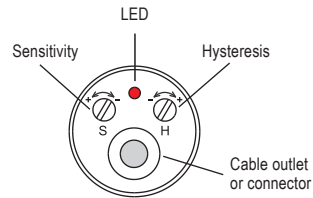

Fig. 18: Top view of level sensor

SENSITIVITY CHARACTERISTICS

Type of sensor	Threshold sensitivity	Hysteresis	Sensitivity adjusting range	Temperature stability	Rel. permittivity of material
DLS-27_-10	0,1 pF	0,1 pF ... 2 pF	min. 8 pF (1 ot. = 1 pF)	$\pm 0,004$ pF/K	min. 1,4
DLS-27_-11	0,2 pF	0,2 pF ... 4 pF	min. 20 pF (1 ot. = 2 pF)	$\pm 0,007$ pF/K	min. 5,0
DLS-27_-20	0,1 pF	0,2 pF ... 3 pF	min. 15 pF (1 ot. = 1,5 pF)	$\pm 0,006$ pF/K	min. 1,3
DLS-27_-21	0,3 pF	0,3 pF ... 6 pF	min. 30 pF (1 ot. = 3 pF)	$\pm 0,01$ pF/K	min. 4,0
DLS-27_-22	0,3 pF	0,3 pF ... 6 pF	min. 30 pF (1 ot. = 3 pF)	$\pm 0,01$ pF/K	min. 4,0
DLS-27_-30	0,2 pF	0,2 pF ... 4 pF	min. 20 pF (1 ot. = 2 pF)	$\pm 0,01$ pF/K	min. 1,6
DLS-27_-31	0,3 pF	0,2 pF ... 5 pF	min. 25 pF (1 ot. = 2,5 pF)	$\pm 0,01$ pF/K	min. 5,0
DLS-27_-40	0,3 pF	0,2 pF ... 6 pF	min. 20 pF (1 ot. = 2 pF)	$\pm 0,01$ pF/K	min. 2,0

9. FUNCTION AND STATUS INDICATION

In the following table are the types of inputs and the respective statuses (ON/ OFF) in the case of a maximum and minimum level sensing. The signalling of the status of the sensor is indicated by the red LED located on the upper area of the sensor beside the setting trimmers of the hysteresis ("H") and the sensitivity ("S").



For minimum level sensing we recommend sensor with normally open output – NO, PO, RO. It is for failure safety reasons – eventual failure of sensor behaves similarly as an exceeding of the limit state. Analogically for maximum level sensing we recommend normally closed outputs – NC, PC, RC.

	Level state	Type of output	Output state	LED
Minimum level sensing		DLS-27N _ _ _ _ -NO _ DLS-27Xd _ _ _ -D-NO _ DLS-27N _ _ _ _ -PO _ DLS-27Xd _ _ _ -D-PO _	CLOSED	 (Shine)
		DLS-27Xi _ _ _ _ -RO _	HIGHER CURRENT	
		DLS-27N _ _ _ _ -NO _ DLS-27Xd _ _ _ -D-NO _ DLS-27N _ _ _ _ -PO _ DLS-27Xd _ _ _ -D-PO _	OPEN	 (Dark)
		DLS-27Xi _ _ _ _ -RO _	LOWER CURRENT	
Maximum level sensing		DLS-27N _ _ _ _ -NC _ DLS-27Xd _ _ _ -D-NC _ DLS-27N _ _ _ _ -PC _ DLS-27Xd _ _ _ -D-PC _	CLOSED	 (Shine)
		DLS-27Xi _ _ _ _ -RC _	HIGHER CURRENT	
		DLS-27N _ _ _ _ -NC _ DLS-27Xd _ _ _ -D-NC _ DLS-27N _ _ _ _ -PC _ DLS-27Xd _ _ _ -D-PC _	OPEN	 (Dark)
		DLS-27Xi _ _ _ _ -RC _	LOWER CURRENT	

10. ORDER CODE

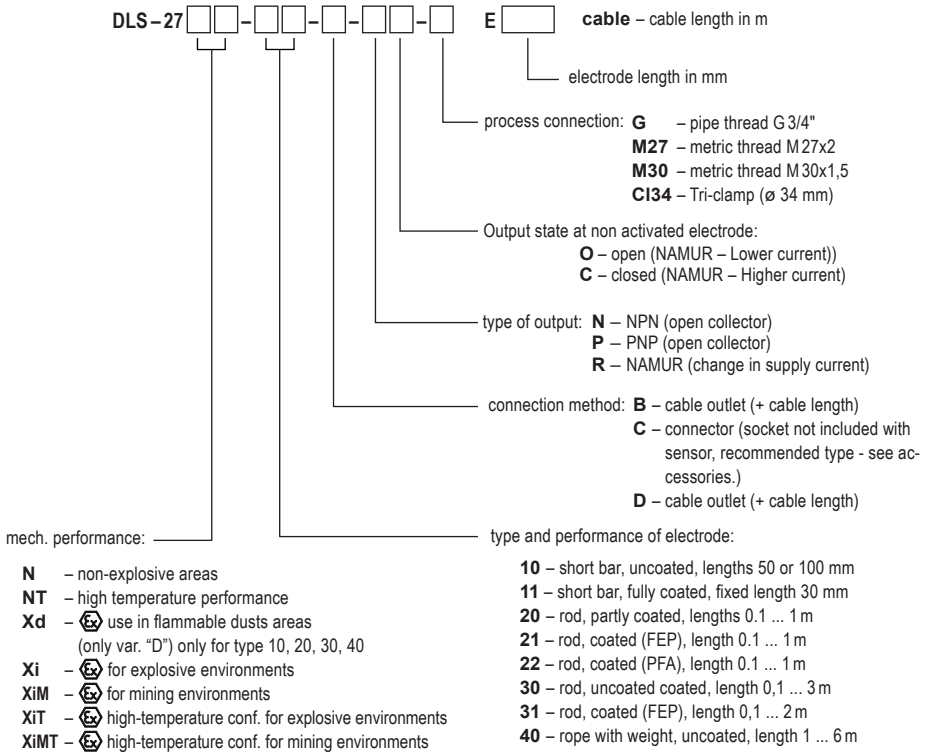

11. CORRECT SPECIFICATION EXAMPLES

DLS-27N-10-B-NO-M27 E100 cable 5 m

(**N**) Normal performance; (**10**) Uncoated bar electrode; (**B**) Cable outlet with 5 m length cable; (**NO**) Output type NPN with open state at non-activated electrode; (**M27**) Metric thread M27x2 process connection; (**E100**) Electrode length 100 mm

DLS-27NT-21-C-PC-G E580

(**NT**) High temperature performance; (**21**) Fully coated rod electrode (FEP); (**C**) Connector; (**PC**) Output type NPN with closed state at non-activated electrode; (**G**) Pipe thread G3/4" process connection; (**E580**) Electrode length 580 mm.

DLS-27Xi-30-C-RO-M30 E1420

(**Xi**) Explosion-proof performance; (**30**) Dismountable uncoated electrode; (**C**) Connector, (**RO**) Output type NAMUR with lower current at non-activated electrode, (**M30**) Metric thread M30x1.5 process connection; (**E1420**) Electrode length 1420 mm.

DLS-27Xd-20-D-NC-G E430 cable 3 m

(**Xd**) Flammable dust areas performance; (**20**) Partly coated electrode; (**D**) Cable outlet; (**NC**) Output type PNP with closed state at non-activated electrode; (**M30**) Metric thread M30x1,5 process connection; (**E430**) Electrode length 430 mm.

12. ACCESSORIES

standard – included in the level sensor price

- 1 pcs. Seal (asbestos free) *
- 1 pcs. Screwdriver for adjustment (each 5 pcs.)

* Pressure resistance - see the table in the accessories datasheet in the "seals and gaskets".

optional – for a surcharge

(see catalogue sheet of accessories)

- Extra cables (over the standard length 2 m)
- Connector socket (type ELWIKa or ELKA)
- Normal steel welding flange ON–27x2
- Stainless steel welding flange NN–G3/4"
- Stainless steel fixing nut UM–27x2
- Other seals (PTFE, Al, etc.)
- Auxiliary plate electrode PDE-27

13. SAFETY, PROTECTIONS, COMPATIBILITY AND EXPLOSION PROOF

The level sensor is equipped with protection against electric shock on the electrode, reverse polarity, output current overload, short circuit and against current overload on output.

Protection against dangerous contact is provided by low safety voltage according to EN 33 2000- 4- 41. Electromagnetic compatibility is provided by conformity with standards EN 55022/B, EN 61326-1, EN 61000-4-2 to -6.

Explosion proof DLS–27Xi (XiT, XiM, XiMT) is provided by conformity with standards EN 60079-0:2013, EN 60079-11:2012.

Explosion proof DLS–27Xd is provided by conformity with standards EN 60079-0:2013, EN 60079-11:2012, EN 60079-31:2014. Explosion proof DLS–27Xd is verified FTZÚ – AO 210 Ostrava – Radvanice: FTZÚ 10 ATEX 0092X.

A declaration of conformity was issued for this device in the wording of Act No. 90/2016 Coll., as amended. Supplied electrical equipment matches the requirements of valid European directives for safety and electromagnetic compatibility.

Special conditions for safe use of variant DLS-27Xi (XiT, XiM, XiMT)

If the apparatus is used as device of Group II and with using of an approved power supply device, which output parameters comply with required input parameters, it is necessary to have an galvanic separation or in case of apparatus without galvanic separation (Zener barriers) it is necessary to provide equipotential equalizing between sensor and barrier earthing point.

If the apparatus is used in coal mine as device of Group I and with using of an approved power supply device, which output parameters comply with required input parameters it is necessary to have an galvanic separation.

When used in zone 0 the present explosive atmosphere of air mixture and gases, vapours of mists must be comply with: $20^{\circ}\text{C} \leq T_{\text{amb}} \leq 60^{\circ}\text{C}$, $0,8 \text{ bar} \leq p \leq 1,1 \text{ bar}$.

Design DLS–27Xi can be used in zone 0 or zone 20. With design DLS–27XiT can be used in zone 0 and zone 20 only electrode part head with electronics can be used only in zone 1 or zone 21.

Ambient temperature: $T_{\text{amb}} = -20^{\circ}\text{C}$ to $+75^{\circ}\text{C}$

Temperature of measured medium according to design variant see chapter "Specification".

For design DLS–27XiMT it is necessary to observe that temperature of any surface of apparatus, when coal dust can from a layer, do not exceed 150°C.

Special conditions for safe use of variant DLS-27Xd

Ambient temperature: $T_{amb} = -20^{\circ}\text{C}$ to $+70^{\circ}\text{C}$

The sensor DLS-27Xd is designed with permanent cable. The cable must be terminated in connection box with degree of protection IP 6X.

The end of the sensor must be protected against direct daylight.

Maximum effective value of AC or DC voltage that can be applied to the terminals of device, which are not intrinsically safe, without breaking the type of protection is $U_m = 253\text{ V}$.

14. USE, MANIPULATION AND MAINTENANCE

The level meter does not require any personnel for its operation. Maintenance of this equipment consists in verification of integrity of the level meter and of the supply cable.



It is forbidden to make any changes or interventions to the DLS–27 sensor without the consent of the producer. Any repairs must only be carried out by the producer or authorized service organisations.

Assembly, installation, commissioning, service and maintenance of the DLS–27 level sensor must be carried out in accordance with this manual and the provisions of valid standards for the installation of electrical equipment must be complied with.

PROCEDURE FOR SHORTENING THE MEASURING ELECTRODE ON VARIANT 40

1. At the rope electrode, it is necessary to loosen three fastening screws on the weight and to pull out the end of the rope, see fig. 19.
2. Make sure that the rope length is correct after shortening – the rope is suspended in the weight up to a distance of approximately 50 mm. Ideally, shorten the rope using diagonal cutting pliers. Be careful to prevent the end of the cable from fraying.
3. Insert the end of the rope back into the weight and secure it in place by tightening all three screws.

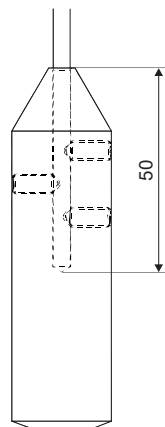

Fig. 19: Picture of the rope with the weight

15. GENERAL, CONDITIONS AND WARRANTY

Dinel, s.r.o. guarantees for the period of three (3) years that the product has the characteristics as mentioned in the technical specification.

Dinel, s.r.o. is liable for defects ascertained within the warranty period and were claimed in writing.

This guarantee does not cover the damages resulting from misuse, improper installation or incorrect maintenance.

This guarantee ceases when the user or the other person makes any changes on the product or the product is mechanically or chemically damaged, or the serial number is not readable.

The warranty certificate must be presented to exercise a claim.

In the case of a rightful complaint, we will replace the product or its defective part. In both cases, the warranty period is extended by the period of repair.

16. MARKING OF LABELS

Labels for device of the type **DLS-27N**:

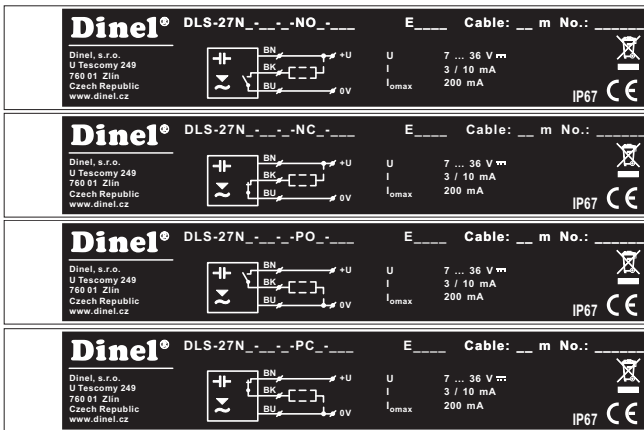

Symbol of producer: logo Dinel®

Contact: Dinel, s.r.o., U Tescomy 249, 760 01 Zlín, www.dinel.cz

Type of level meter: DLS-27N_ _ _ _ _ Exxxx

Cable length: Cable: _ _ m

Serial number: Ser. No.: _____ – (from the left: production year, serial production number)

Supply voltage: $U = 7 \dots 36 \text{ V} \overline{\text{m}}$

Current supply: $I = 3 / 10 \text{ mA}$

Maximum switching current: $I_{\text{omax}} = 200 \text{ mA}$

Compliance mark: **CE**

Protection class: IP67, Electro-waste take-back system mark:

Labels for device of the type **DLS-27Xd**:

Dinel® DLS-27Xd--D-NO-- E____ Cable: __ m No.: _____ Dinel, s.r.o. U Tescomy 249 760 01 Zlín Czech Republic www.dinel.cz		II 1/2D Ex ia/tb [ia] IIC T78°C Da/Db $U = 7 \dots 33 \text{ V} \dots$ $I = 3 / 10 \text{ mA}$ $I_{max} = 200 \text{ mA}$ $t_a = -20 \dots +70 \text{ °C}$ Cert. No.: FTZÚ 10 ATEX 0092X	IP67 1026
Dinel® DLS-27Xd--D-NC-- E____ Cable: __ m No.: _____ Dinel, s.r.o. U Tescomy 249 760 01 Zlín Czech Republic www.dinel.cz		II 1/2D Ex ia/tb [ia] IIC T78°C Da/Db $U = 7 \dots 33 \text{ V} \dots$ $I = 3 / 10 \text{ mA}$ $I_{max} = 200 \text{ mA}$ $t_a = -20 \dots +70 \text{ °C}$ Cert. No.: FTZÚ 10 ATEX 0092X	IP67 1026
Dinel® DLS-27Xd--D-PO-- E____ Cable: __ m No.: _____ Dinel, s.r.o. U Tescomy 249 760 01 Zlín Czech Republic www.dinel.cz		II 1/2D Ex ia/tb [ia] IIC T78°C Da/Db $U = 7 \dots 33 \text{ V} \dots$ $I = 3 / 10 \text{ mA}$ $I_{max} = 200 \text{ mA}$ $t_a = -20 \dots +70 \text{ °C}$ Cert. No.: FTZÚ 10 ATEX 0092X	IP67 1026
Dinel® DLS-27Xd--D-PC-- E____ Cable: __ m No.: _____ Dinel, s.r.o. U Tescomy 249 760 01 Zlín Czech Republic www.dinel.cz		II 1/2D Ex ia/tb [ia] IIC T78°C Da/Db $U = 7 \dots 33 \text{ V} \dots$ $I = 3 / 10 \text{ mA}$ $I_{max} = 200 \text{ mA}$ $t_a = -20 \dots +70 \text{ °C}$ Cert. No.: FTZÚ 10 ATEX 0092X	IP67 1026

Symbol of producer: logo Dinel®

Contact: Dinel,s.r.o., U Tescomy 249, 760 01 Zlín, www.dinel.cz

Type of level meter: DLS-27Xd-_-_-_- Exxxx

Cable length: Cable: __ m

Serial number: Ser. No.: _____ – (from the left: production year, serial production number)

Mark of non-explosive device: , variant: II 1/2 D Ex ia/tb [ia] IIC T78°C Da/Db

Supply voltage: $U = 7 \dots 33 \text{ V} =$

Current supply: $I = 3 / 10 \text{ mA}$

Maximum switching current: $I_{max} = 200 \text{ mA}$

Ambient temperature range: $t_a = -20 \dots +70 \text{ °C}$

Number of certificate of intrinsic safety: FTZÚ 10 ATEX 0092X

Compliance mark: , Number of authorized person supervising over the quality system: 1026

Protection class: IP67, Electro-waste take-back system mark:

Labels for device of the type **DLS-27Xi**; **DLS-27XiT**
for type electrode 10, 20, 30, 40

Dinel® DLS-27Xi--_R-- E____ Cable: __ m No.: _____ Dinel, s.r.o. U Tescomy 249 760 01 Zlín Czech Republic www.dinel.cz		II 1 G Ex ia IIB T6 Ga II 1 D Ex ia IIC T 76°C Da $U_i = 12 \text{ V} \dots$ $I_i = 15 \text{ mA}$ $P_i = 45 \text{ mW}$ $C_i = 15 \text{ nF}$ $L_i = 10 \text{ uH}$ $t_a = -20 \dots +75 \text{ °C}$ $t_b = -20 \dots +60 \text{ °C (zone 0)}$	FTZÚ 02 ATEX 0234X IP67 1026
Dinel® DLS-27XiT--_R-- E____ Cable: __ m No.: _____ Dinel, s.r.o. U Tescomy 249 760 01 Zlín Czech Republic www.dinel.cz		II 1/2 G Ex ia IIB T6 Ga/Gb II 1/2 D Ex ia IIC T 76°C Da/Db $U_i = 12 \text{ V} \dots$ $I_i = 15 \text{ mA}$ $P_i = 45 \text{ mW}$ $C_i = 15 \text{ nF}$ $L_i = 10 \text{ uH}$ $t_a = -20 \dots +75 \text{ °C}$ $t_b = -20 \dots +60 \text{ °C (zone 0)}$	FTZÚ 02 ATEX 0234X IP67 1026

for type electrode 11, 21, 22, 31

Dinel® DLS-27Xi--_R-- E____ Cable: __ m No.: _____ Dinel, s.r.o. U Tescomy 249 760 01 Zlín Czech Republic www.dinel.cz		II 1 G Ex ia IIB T6 Ga $U_i = 12 \text{ V} \dots$ $I_i = 15 \text{ mA}$ $P_i = 45 \text{ mW}$ $C_i = 15 \text{ nF}$ $L_i = 10 \text{ uH}$ $t_a = -20 \dots +75 \text{ °C}$ $t_b = -20 \dots +60 \text{ °C (zone 0)}$	FTZÚ 02 ATEX 0234X IP67 1026
Dinel® DLS-27XiT--_R-- E____ Cable: __ m No.: _____ Dinel, s.r.o. U Tescomy 249 760 01 Zlín Czech Republic www.dinel.cz		II 1/2 G Ex ia IIB T6 Ga/Gb $U_i = 12 \text{ V} \dots$ $I_i = 15 \text{ mA}$ $P_i = 45 \text{ mW}$ $C_i = 15 \text{ nF}$ $L_i = 10 \text{ uH}$ $t_a = -20 \dots +75 \text{ °C}$ $t_b = -20 \dots +60 \text{ °C (zone 0)}$	FTZÚ 02 ATEX 0234X IP67 1026

Symbol of producer: logo Dinel®

Contact: Dinel,s.r.o., U Tescomy 249, 760 01 Zlín, www.dinel.cz

Type of level meter: DLS-27Xi (XiT)-__-R-__ Exxxx

Cable length: Cable: __ m

Serial number: Ser. No.: _____ – (from the left: production year, serial production number)

Mark of non-explosive device: , variant (Xi): II 1 G Ex ia IIB T6 Ga; II 1 D Ex ia IIIC T76°C Da
or variant (XiT): II 1/2 G Ex ia IIB T6 Ga/Gb; II 1/2 D Ex ia IIIC T76°C Da/Db

Limit parameters: $U_i = 12\text{ V}$, $I_i = 15\text{ mA}$; $P_i = 45\text{ mW}$; $C_i = 15\text{ nF}$; $L_i = 10\text{ }\mu\text{H}$

Ambient temperature range for the zone 0: $t_a = -20 \dots +60\text{ }^\circ\text{C}$

Ambient temperature range: $t_a = -20 \dots +75\text{ }^\circ\text{C}$

Number of certificate of intrinsic safety: FTZÚ 02 ATEX 0234X

Compliance mark: , Number of authorized person supervising over the quality system: 1026

Protection class: IP67, Electro-waste take-back system mark: 

Labels for device of the type DLS-27XiM; DLS-27XiMT

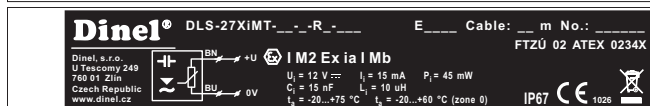
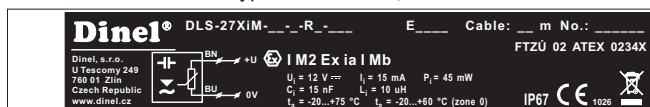

Symbol of producer: logo Dinel®

Contact: Dinel,s.r.o., U Tescomy 249, 760 01 Zlín, www.dinel.cz

Type of level meter: DLS-27Xi (XiT)-__-R-__ Exxxx

Cable length: Cable: __ m

Serial number: Ser. No.: _____ – (from the left: production year, serial production number)

Mark of non-explosive device: , variant: I M2 Ex ia I Mb

Limit parameters: $U_i = 12\text{ V}$, $I_i = 15\text{ mA}$; $P_i = 45\text{ mW}$; $C_i = 15\text{ nF}$; $L_i = 10\text{ }\mu\text{H}$

Ambient temperature range for the zone 0: $t_a = -20 \dots +60\text{ }^\circ\text{C}$

Ambient temperature range: $t_a = -20 \dots +75\text{ }^\circ\text{C}$

Number of certificate of intrinsic safety: FTZÚ 02 ATEX 0234X

Compliance mark: , Number of authorized person supervising over the quality system: 1026

Protection class: IP67, Electro-waste take-back system mark: 



Size of labels 97 x 12 mm, the size shown does not correspond to reality.

17. TECHNICAL SPECIFICATIONS

TECHNICAL DATA		
Supply voltage	performance DLS-27N performance DLS-27Xd	7 ... 36 V DC 7 ... 33 V DC
Current supply (state OFF / ON)		3 / 10 mA *
Max. switching current (NPN, PNP)	performance DLS-27N performance DLS-27Xd	200 mA 200 mA
Residual voltage – ON state		max. 1,5 V
Delay of output signal due to electrode activation		0,2 s
Input resistance / Electric strength		1 MΩ / 1 kV AC
Coupling capacity / Electric strength		47 nF / 250 V AC *
Protection class		IP 67
Cable (version with cable outlets)		PVC 3 x 0,5 mm ² or 2 x 0,75 mm ²
Weight (excl. electrode, cable 2 m)	DLS-27_ DLS-27_T	cca 0,4 kg cca 0,7 kg

* Only for variants "N" and "Xd"

ELECTRICAL PARAMETERS – variants Xi, XiT, XiM, XiMT	
Supply voltage	8 ... 9 V DC
Current supply (state OFF / ON) – NAMUR	≤ 1 mA / ≥ 2,2 mA
Limit parameters	Ui=12VDC; Ii=15mA; Pi=45mW; Ci=15nF; Li=10μH
Coupling capacity / Electric strength	2,7 nF / 500 V AC
Reference value LC for the parameters of the used cable	typ. C < 150 pF/m typ. L < 0,8 μH /m

USED MATERIALS		
Part of the DLS	Type	Standard material *
Housing	All type	W.Nr. 1.4301 (AISI 304)
Insulating bushing	All type	Teflon® PTFE (Polytetrafluoroethylene)
Electrode	DLS-27_-10,11,20,21,22,30,31 DLS-27_-40	W.Nr. 1.4404 (AISI 316 L) W.Nr. 1.4401 (AISI 316)
Electrode coating	DLS-27_-11	Teflon® PTFE (Polytetrafluoroethylene)
Electrode coating	DLS-27N-20, 21, 31 DLS-27Xi-21, 31	Teflon® FEP (Fluorinated ethylene propylene)
Electrode coating	DLS-27Xd(Xi, XiT) -20	Electrostatically conductive PTFE Ex
Electrode coating	DLS-27_-22	Teflon® PFA (Perfluoroalkoxy)
Weight	DLS-27_-40	W.Nr. 1.4301 (AISI 304)

* On request can be selected other type of material.

WORKING AREAS (EN 60079-0, EN 60079-10-1(2))

DLS-27N	Basic performance for non-explosive atmospheres.
DLS-27NT	High-temperature basic performance for non-explosive atmospheres.
DLS-27Xd (10, 20, 30, 40)	Performance is protected by "Ex t" lock with intrinsically safe electrical circuit „ia" for hazardous areas (flammable dust areas) Ⓜ II 1/2 D Ex ia/tb [ja] IIIC T78°C Da/Db, electrode part zone 20, housing with electronics zone 21 see Fig. 20. The type 20 has electrode coating from electrostatically conductive PTFE Ex.
DLS-27Xi (10, 20, 30, 40)	Intrinsically safe explosion-proof performance for use in hazardous areas (explosive gas atmospheres or explosive atmospheres with dust) Ⓜ II 1 G Ex ia IIB T6 Ga; Ⓜ II 1 D Ex ia IIIC T76°C Da with intrinsically safe supply units, electrode part zone 0 and 20. Only Type 10, 20, 30, 40. The type 20 has electrode coating from electrostatically conductive PTFE Ex.
DLS-27Xi (11, 21, 22, 31)	Intrinsically safe explosion-proof performance for use in hazardous areas (explosive gas atmospheres) Ⓜ II 1 G Ex ia IIB T6 Ga with intrinsically safe supply units, whole sensor zone 0.
DLS-27XiT (10, 20, 30, 40)	Intrinsically safe high-temperature explosion-proof performance for use in hazardous areas (explosive gas atmospheres or explosive atmospheres with dust) Ⓜ II 1/2 G Ex ia IIB T6 Ga/Gb; Ⓜ II 1/2 D Ex ia IIIC T76°C Da/Db with intrinsically safe supply units, electrode part zone 0 and 20, housing zone 1 and 21, see Fig. 20. The type 20 has electrode coating from electrostatically conductive PTFE Ex.
DLS-27XiT (11, 21, 22, 31)	Intrinsically safe high-temperature explosion-proof performance for use in hazardous areas (explosive gas atmospheres) Ⓜ II 1/2 G Ex ia IIB T6 Ga/Gb with intrinsically safe supply units, electrode part zone 0, housing zone 1 see Fig. 20.
DLS-27XiM	Intrinsically safe explosion-proof performance for use in mines with the occurrence of methane or coal dust Ⓜ I M2 Ex ia I Mb with intrinsically safe supply units.
DLS-27XiMT	Intrinsically safe high-temperature explosion-proof performance for use in mines with the occurrence of methane or coal dust Ⓜ I M2 Ex ia I Mb with intrinsically safe supply units.

PROCESS CONNECTION

Type	Size	Marking
Pipe thread	G 3/4"	G
Metric thread	M27x2	M27
Metric thread	M30x1,5	M30
Jointless connection (Tri-Clamp) (DN 20)	ø 34 mm	CI34

TYPE OF OUTPUT

Output	Variants
NPN (NC; NO)	N, NT, Xd
PNP (PC; PO)	N, NT, Xd
NAMUR (RC; RO)	Xi, XiM, XiT, XiMT

TEMPERATURE AND PRESSURE RESISTIVITY

variant	temperature t_m	temperature t_p	temperature t_a	max. operating pressure for temperature t_p				
				Up to 30°C	Up to 85°C	Up to 120°C	Up to 150°C	Up to 180°C
DLS-27N-10, 11	-40°C ... +100°C	-25°C ... +85°C	-20°C ... +80°C	3 MPa	2 MPa	–	–	–
DLS-27N-20, 30	-40°C ... +300°C	-25°C ... +85°C	-20°C ... +80°C	3 MPa	2 MPa	–	–	–
DLS-27N-21, 22, 31, 40	-40°C ... +200°C	-25°C ... +85°C	-20°C ... +80°C	3 MPa	2 MPa	–	–	–
DLS-27NT-10, 11, 21, 22, 31, 40	-40°C ... +200°C	-40°C ... +200°C	-20°C ... +80°C	3 MPa	2 MPa	0,5 MPa	0,3 MPa	0,1 MPa
DLS-27NT-20, 30	-40°C ... +300°C	-40°C ... +200°C	-20°C ... +80°C	3 MPa	2 MPa	0,5 MPa	0,3 MPa	0,1 MPa
DLS-27Xd	-20 ... +70°C	-20 ... +70°C	-20 ... +70°C	3 MPa	2 MPa	–	–	–
DLS-27Xi, XiM	-20°C ... +85°C	-25°C ... +85°C	-20°C ... +75°C	3 MPa	2 MPa	–	–	–
DLS-27XiT, XiMT-10, 11, 20, 30	-30°C ... +200°C	-40°C ... +200°C	-20°C ... +75°C	3 MPa	2 MPa	0,5 MPa	0,3 MPa	0,1 MPa
DLS-27XiT, XiMT-21, 22, 31, 40	-30°C ... +120°C	-40°C ... +180°C	-20°C ... +75°C	3 MPa	2 MPa	0,5 MPa	0,3 MPa	0,1 MPa
DLS-27Xi, XiT, XiM, XiMT – zone 0	-20 ... +60°C	-20 ... +60°C	-20 ... +60°C	0,08... 0,11 MPa up to 30°C				
DLS-27XiM (XiMT) - mine application Mb	Max. 150°C any surface where the coal-dust may consist layer							

Note: For the correct operation of the level meter, none of the here provided temperature ranges may be exceeded (t_p , t_m or t_a).
 1) The here-mentioned temperatures are visually explain in Fig. 20.

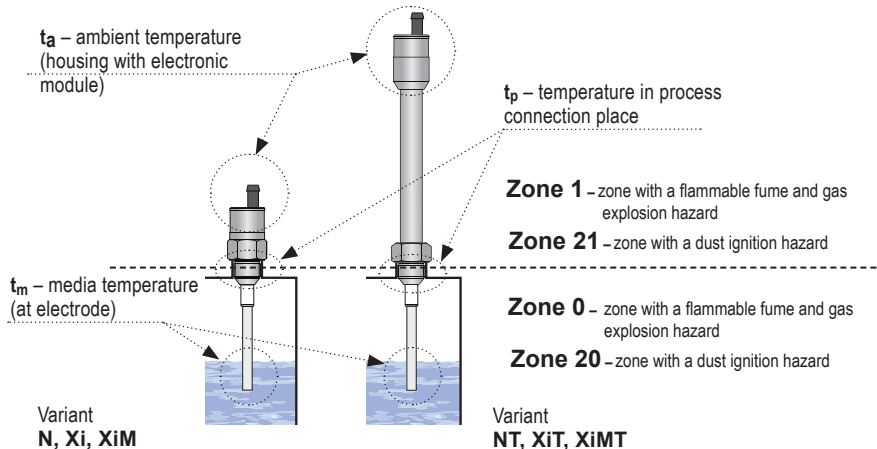

Fig. 20: Illustration of areas for temperature measurement and explosive zones

18. PACKINGS, SHIPPING AND STORAGE

The device DLS–27 is packaged in a polyethylene bag, and the entire consignment is placed into a cardboard box. A suitable filler material is used in the cardboard box to prevent mechanical damage during transport.

Remove the device from the packaging only just before using, thereby protecting it from potential damage.

A forwarding company will be used to ship goods to the customer. Upon prior agreement, ordered goods can be picked up in person at company headquarters. When receiving, please check to see that the consignment is complete and matches the order, or to see if any damage has occurred to the packaging and device during transport. Do not use a device clearly damaged during transport, but rather contact the manufacturer in order to resolve the situation.

If the device is to be further shipped, it must be wrapped in its original packaging and protected against impact and weather conditions.

Store the device in its original packaging in dry areas covered from weather conditions, with humidity of up to 85 % without effects of chemically active substances. The storage temperature range is -10 °C to +50 °C.



All sensors except type variants DLS–27_–20, 21, 22, 30 are given protective covers at ends of electrodes (longer than 100 mm) and of reference tubes in order to prevent damage to electrode and tubes, tearing of the package or injury of persons handling them. Remove the cover prior to putting into operation.

19. FAQ (FREQUENTLY ASKED QUESTIONS)

Question	Answer / Solution
The sensor does not have sharp switching, the connected relay grumbles.	Did you use the correct supply? It is necessary to use the source of DC smoothing voltage (not only rectified pulsing voltage), the best supply unit is Dinel or another suitable stabilized source.
The sensor does not have sharp switching, the connected relay during the transfer from one status to the other status grumbles despite the fact that the supply is OK.	Is the hysteresis set on the sensor correctly? It will be necessary to increase the hysteresis by trimmer "H" (by turning in a clockwise direction).
After the connection of the correct supply, the sensor does not switch the load.	Did you select and connect the load correctly? Does the load have the character of the bulb (very small resistance in inactive status) or does it not contain higher capacitors? With the output it is only possible to switch the resistance and inductive loads, see connection of sensors (Fig. 14, 15, 16). Type of output PNP – the load is connected between the output and zero potential. Type NPN – the load between the output and the positive field of the supply.
After activation (filling, flooding), the sensor does not switch.	Is the sensitivity of the sensor too high? The electronics of the sensor are evidently only activated by the case (head) and the electrode or remainders on the electrode. It is necessary to decrease the sensitivity by trimmer "S" (to turn in clockwise direction).
After connection of the supply, the sensor is disconnected and is switched by touching with the hand. Then, it will remain permanently switched. It is necessary to disconnect it from the source and connect it again.	The sensor is evidently set so that it has too large hysteresis and the change of the capacity after deactivation is insufficient for exceeding the area of hysteresis and re-disconnection. It is sufficient to decrease the hysteresis or to modify (decrease) the sensitivity so that the sensor is able to achieve both marginal statuses – connection and disconnection.
The sensor is disconnected from the side. After installation, the sensor responded to the conductive liquid several times, but then responses stopped and it remained in the activated status. The decrease of the sensitivity did not help.	This mainly concerns the liquid which is able to create a continuous, electrically conductive coat on the electrode (or the insulation). An example of such liquids are some lye and alkaline washing detergents, flushing water with metal content, etc. It is always necessary to test the function or to select the assembly from upwards.
Does the dust badly affect the function of DLS sensors?	No. The dust have almost no effect to function (as similar as dry non-conductive adhered rests of material). The state of sensor changes only when the mass of material covers the electrode. The different situation is when the insulating bushing is covered by mixture of condensed water and dust. These problems can be solved by type choice of sensor and right sensitivity setting
Does the DLS sensor react on foams on the level?	There exist various foams and capacitive sensors react on them differently. When the base of foam is electrically conductive solution (e.g. beer) we can DLS sensor use for foam detection, but it is possible to make them on foams insensitive (by means of type choice, sensitivity setting). The DLS sensors are generally insensitive on foams from non-conductive liquids (plant oils)

Dinel[®]

industrial electronics

Dinel, s.r.o.
U Tescomy 249
760 01 Zlín
Czech Republic

Phone: +420 577 002 002
Fax: +420 577 002 007
E-mail: sale@dinel.cz

www.dinel.cz

Find the updated version at www.dinel.cz

version: 01/2019

