

- Detect liquids in glass or plastic pipes, indicate liquids in inter-coat space of double coated tanks
- Adjustable sensitivity
- NPN, PNP or NAMUR output
- Material of housing and nut from stainless steel
- Version for usage in explosive areas
- LED state indication

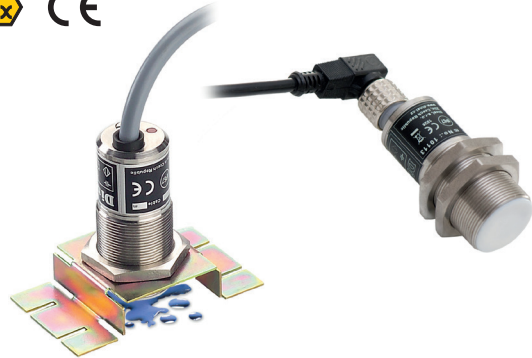

Capacitive proximity switch CPS-24 is intended for detection of proximity or motion of solid objects. It is suitable for indication of the liquid level through non-conductive walls of vessels or on non-conductive gauge-pipes. It is excellent for liquid leakage detection in collection pits or directly on floors. The sensor state is indicated by LED. The sensitivity is adjustable by a trimmer located under a cover screw on the rear side. The design and housing materials of CPS allow the use in complicated environments (harsh, dusty, explosive, aggressive) as well as in clean environments (medical technology).

DIMENSIONAL DRAWING

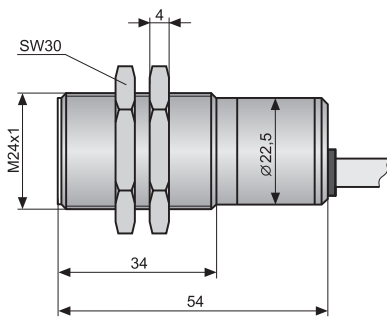

Variant "A" with short cable outlet

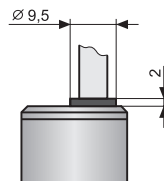

Variant "B" with long cable outlet

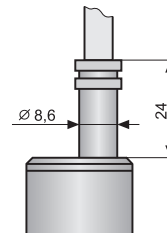

Variant "C" with connector

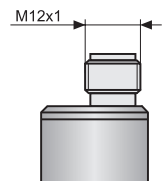

SPECIFICATIONS

TECHNICAL SPECIFICATIONS

Supply voltage		7 ... 36V DC *
Current supply (state OFF / ON)		3 / 6mA *
Switching current (NPN, PNP output)		200mA *
Electric strength		500V AC
Coupling capacity		2.2nF
Max. switching frequency		5Hz
Sensitivity – sensing distance		0 ... 10mm (adjustable)
Hysteresis		5 ... 15%
Ambient temperature range		-20 ... +70°C
Protection class		IP67
Cable (version with cable outlets)	CPS-24N CPS-24Xi	PVC 3x0.5 mm ² PVC 2x0.75 mm ²
Weight (incl. 2 m cable)		Approx. 0.3kg

* Only for variants "N"

ELECTRICAL PARAMETERS – variant Xi

Supply voltage	8 ... 9V DC (Max. 12V DC)
Current supply (state OFF / ON) – NAMUR	≤ 1 mA / ≥ 2.2 mA
Max. internal values	$U_i = 12\text{VDC}$; $I_i = 15\text{mA}$; $P_i = 45\text{mW}$; $C_i = 15\text{nF}$; $L_i = 10\mu\text{H}$

WORKING AREAS (EN 60079-0, EN 60079-10-1(2))

CPS-24N	Basic performance for non-explosive atmospheres.
CPS-24Xi	Intrinsically safe explosion-proof performance for use in hazardous areas (explosive gas atmospheres or explosive atmospheres with dust), Ex II 1G Ex ia IIC T6 Ga with intrinsically safe supply units, whole sensor zone 0.

USED MATERIALS

Part of the sensor	Material
Housing	St. steel W.Nr. 1.4301
Sensing surface	PTFE
Ending	St. steel W.Nr. 1.4301
Cable outlet (Variant "A")	Plastic POM
Cable outlet (Variant "B")	St. steel W.Nr. 1.4301

TYPE OF OUTPUT

Output	Variants
NPN ("NC", "NO")	N
PNP ("PC", "PO")	N
NAMUR ("RC", "RO")	Xi

INSTALLATION INSTRUCTIONS

Sensing of **bulky-solid materials** in metal containers or tanks. The position of the sensor is set so that it is approximately 10 mm from the inner wall of a storage tank.

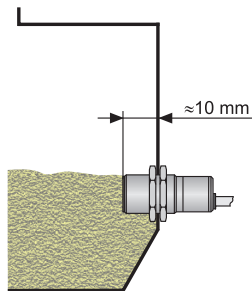

Sensing bulk-solid materials in storage tanks

Sensor is used for sensing leakages in an **interception tank**. Leakage indication in detention pits and boxes with "Plate holder PD-24-1".

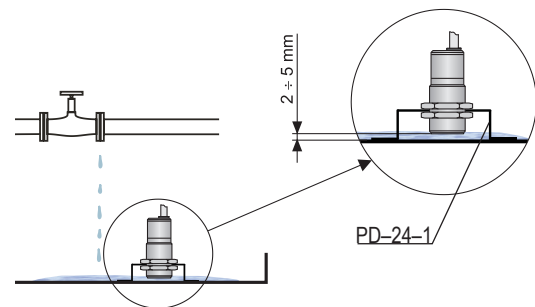

Use of CPS for sensing leakages in an interception tank

Sensing of moving **objects on conveyor**. The distance of the sensor from moving objects is set according to their size, shape and material composition (approx. 1 to 8 mm).

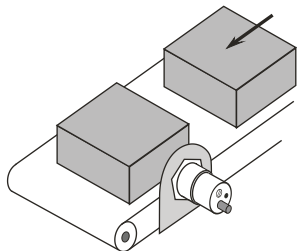

Sensing objects on a conveyor

Sensor application for **level gauges** and **eye sights**. The maximum wall thickness in both cases is up to 10 mm. A glass or plastic level gauge (tube) must have an outer diameter of at least 20 mm. The face of the sensor must be touching the wall.

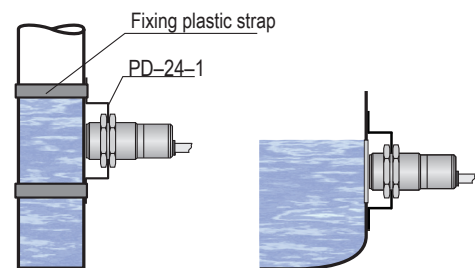

CPS sensor application for level gauges and eye sights

Detection of liquid presence in the **inter-wall space** of double-walled storage tanks. The sensor is suspended down into the inter-wall space on its own cable. For this application, we recommend variant „B“ with an extended cable terminal with the installation variant of a PVC hose for cable protection.

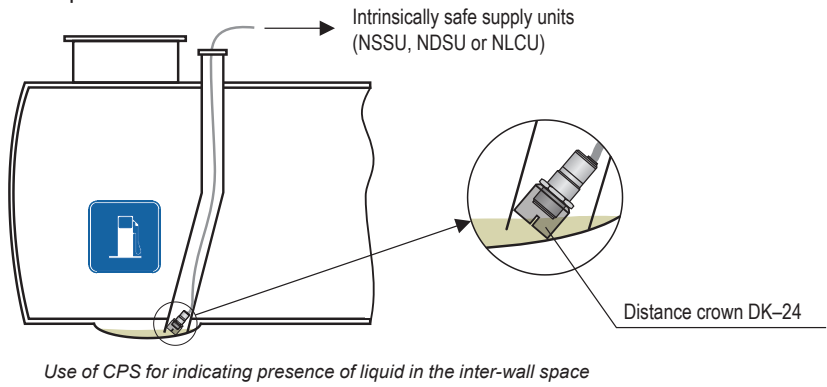

In the case of vertical mounting in outer areas or in the case of high mechanical exertion we recommend to install in Variant "B" **protective hose** on the cable (see figure).

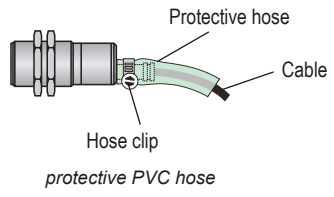

ELECTRICAL CONNECTION

Sensor with NPN or PNP output is allowed to lead only by resistive or inductive load. Positive supply voltage (+U) is connected to the brown conductor BN (1), negative (0V) to the blue conductor BU (3) and the leads (only NPN or PNP type of output) to the black conductor BK (4). The capacity loads and low resistance loads (bulb) is evaluated by the sensor as short circuit.

The line from CPS-24N to the connecting device is from a suitable three wire (min. 3x0.5 mm²) cable, in the case of variant CPS-24Xi using a two wire (min. 2x0.5 mm²) cable. In the event that a disassemblable socket ELWIKA or ELKA 4012 K PG7 are used, the max. outer diameter of the cable is 6 mm. Connector socket is not part of the sensor.

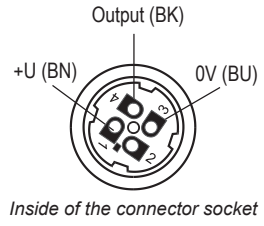
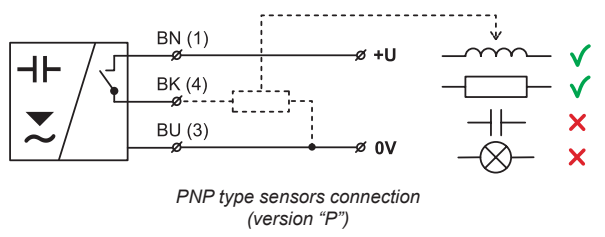
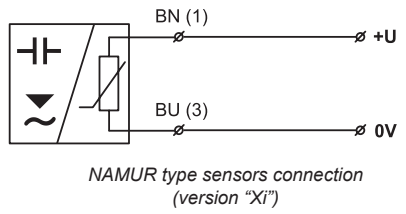
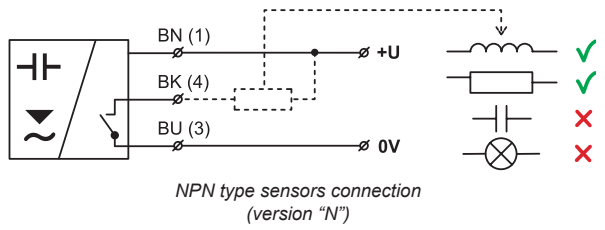

Legend:
 (*) – Numbers of terminals inside of the connector
 BK – Black
 BN – Brown
 BU – Blue



Electrical connection can only be made when de-energized!

The source of the power voltage must comprise of a stabilised safe low power source with galvanic separation. In the event that a switch-mode power supply is used, it is essential that its construction effectively suppresses common mode interference on the secondary side. In the event that the switch-mode power supply is equipped with a PE safety terminal, it must be unconditionally grounded! Spark-safe devices (type CPS-24) must be powered from a spark-safe power source meeting the above-mentioned requirements.



Due to the possible occurrence of an electrostatic charge on the non-conductive parts of the sensor, it is necessary to ground all sensors intended for use in environments with an explosion hazard (type CPS-24Xi). This can be performed by grounding el. conductive tanks or el. conductive tank lids, and in the case of el. non-conductive tanks using and grounding an auxiliary plate electrode PDE-27.

In the event that the water level meter (sensor) is installed in an outdoor environment at a distance greater than 20 m from the outdoor switchboard, or from an enclosed building, it is necessary to supplement the electrical cable leading to the water level meter (sensor) with suitable overvoltage protection.

In the event of strong ambient electromagnetic interference, paralleling of conductors with power distribution, or for distribution to distances over 30 m, we recommend using a shielded cable and grounding the shielding on the side of the power source.

SETTINGS

The sensitivity is set by trimmer located under cover screw on the rear side. Clockwise turning makes the sensitivity lower, reverse direction turning makes the sensitivity higher. The base sensitivity of the sensor is factory set (sensing distance on the metal surface) 8 mm. The actual sensitivity (sensing distance) depends on the dielectric properties or where appropriate the conductivity of the sensed material.

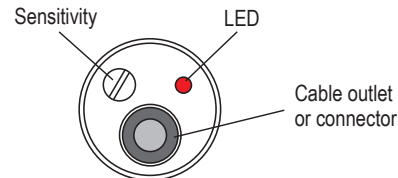

Top view of level sensor

RANGE OF APPLICATION

Detection of approach or assessment of the movement of solid objects, level indication in electrically non-conductive storage tanks (plastic, glass) and level gauges. Limit sensing of non-abrasive bulk-solid materials (cereals, grains, granulates, sand, etc.) in metal storage tanks. Detection of the presence of liquids in the inter-wall area of double-walled storage tanks, liquid leakage detection in interception traps, concrete sumps or directly on the floor.



We do not recommend using for the measurement of el. conductive liquids that leave a continuous film on the inner wall of an el. non-conductive storage tank or level gauge and liquids that exude el. conductive particles that deposit themselves on the wall of a storage tank or level gauge (e.g. heavily mineralised water, chemically treated waste water). Likewise, the sensor is also not intended for measuring levels on level gauges and walls of storage tanks with antistatic treatment (partially electrically conductive).

FUNCTION AND STATUS INDICATION

	Level state	Type of output	Output state	LED indication
Minimum level sensing		CPS-24N--NO CPS-24N--PO	CLOSED	 (Shine)
		CPS-24Xi--RO	HIGHER CURRENT	
		CPS-24N--NO CPS-24N--PO	OPEN	 (Dark)
		CPS-24Xi--RO	LOWER CURRENT	
Maximum level sensing		CPS-24N--NC CPS-24N--PC	CLOSED	 (Shine)
		CPS-24Xi--RC	HIGHER CURRENT	
		CPS-24N--NC CPS-24N--PC	OPEN	 (Dark)
		CPS-24Xi--RC	LOWER CURRENT	

For **minimum level** sensing we recommend sensor with normally open output (NO, PO, RO). It is for failure safety reasons – eventual failure of sensor behaves similarly as an exceeding of the limit state.

Analogically for **maximum level** sensing we recommend normally closed outputs (NC, PC, RC).

For leakage indication we recommend the NC, PC, RC version too. It is **maximum level** sensing as well, despite the sensor is at the lowest place in the room.

ORDER CODE

CPS-24□-□-□-□

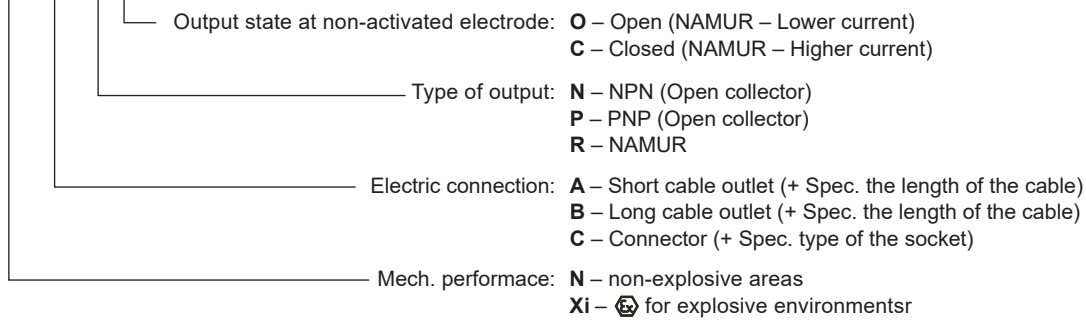

CORRECT SPECIFICATION EXAMPLES

CPS-24N-A-PC cable 4 m

(N) Performance for non-explosive areas; (A) Short cable outlet with 4 m cable length; (PC) Output type PNP with closed state at non-activated electrode.

CPS-24Xi-B-RO cable 7 m

(Xi) Explosion-proof performance; (B) Long cable outlet with 7 m cable length; (RO) Output type NAMUR with lower current at non-activated electrode

CPS-24N-C-NO cable 7 m

(N) Performance for non-explosive areas; (C) Connector; (NO) Output type NPN with open state at non-activated electrode.

ACCESSORIES

Standard - included in the level sensor price

- 2 m cable (for electric connection type "A" or "B")
- 2 pcs. of stainless steel fixing nuts
- 1 pcs. Screwdriver for adjustment (each 5 pcs.)

Optional – for a surcharge (see catalogue sheet of accessories)

- Extra cables over the standard length 2 m (for electric connection type "A" or "B")
- Connector plug (type ELWIK or ELKA)
- Plate holder PD-24-1
- Distance crown DK-24

SAFETY, PROTECTIONS, COMPATIBILITY AND EXPLOSION PROOF

The level sensor is equipped with protection against electric shock on the electrode, reverse polarity, output current overload, short circuit and against current overload on output.

Protection against dangerous contact is provided by low safety voltage according to EN 33 2000-4-41. Electromagnetic compatibility is provided by conformity with standards EN 55 022/B, EN 61326-1/Z1, EN 61000-4-2, EN 61000-4-3, EN 61000-4-4, EN 61000-4-6.

Explosion proof CPS-24Xi is provided by conformity with standards EN IEC 60079-0:2018, EN 60079-11:2012.

Explosion proof CPS-24Xi is verified FTZÚ Ostrava – Radvanice: FTZÚ 02 ATEX 0233X

A declaration of conformity was issued for this device in the wording of Act No. 90/2016 Coll., as amended. Supplied electrical equipment matches the requirements of valid European directives for safety and electromagnetic compatibility.

Special conditions for safe use of variant CPS-24Xi

The level sensor is designed to be connected with supply unit type NSSU, NDSU and NLCU. If some other approved apparatus is used, its output parameters comply with above mentioned parameters, then it is necessary to include galvanic separation and/or in case of application of apparatus without galvanic separation (Zener safety barriers) it is necessary to provide equipotential equalisation between sensor and point of barrier earthing.

Ambient temperature: $-20^{\circ}\text{C} \leq T_a \leq +70^{\circ}\text{C}$

Intrinsically safe parameters:

$U_i = 12\text{ V}$; $I_i = 15\text{ mA}$; $P_i = 45\text{ mW}$; $C_i = 28\text{ nF}$; $L_i = 10\text{ }\mu\text{H}$

version 04/2022



QMS
ISO 9001

Dinel, s.r.o.
U Tescomy 249
760 01 Zlín, Czech Republic

Phone: +420 577 002 003

CPS-24-dat-5.3

sale@dinel.cz
www.dinel.cz