



CAPACITIVE LEVEL SENSORS DLS-35



CONTENTS

1. Basic description	4
2. Variants of sensors	5
3. Dimensional drawings	6
4. Installation and putting into operation	8
5. Installation instructions	8
6. Range of application and installation of individual variants	12
7. Electrical connection	14
8. Control elements	15
9. Settings	16
10. Function and status indication	19
11. Order code	20
12. Correct specification examples	20
13. Accessories	21
14. Safety, protections, compatibility and explosion proof	21
15. Use, manipulation and maintenance	22
16. General, conditions and warranty	22
17. Marking of labels	22
18. Technical specifications	24
19. Packings, shipping and storage	29

USED SYMBOLS

To ensure maximum safety of control processes, we have defined the following safety instructions and information. Each instruction is labelled with the appropriate pictogram.



Alert, warning, danger

This symbol informs you about particularly important instructions for installation and operation of equipment or dangerous situations that may occur during the installation and operation. Not observing these instructions may cause disturbance, damage or destruction of equipment or may cause injury.



Information

This symbol indicates particularly important characteristics of the device.



Note

This symbol indicates helpful additional information.

SAFETY



All operations described in this instruction manual have to be carried out by trained personnel or by an accredited person only. Warranty and post warranty service must be exclusively carried out by the manufacturer.

Improper use, installation or set-up of the sensor can lead to crashes in the application.

The manufacturer is not responsible for improper use, loss of work caused by either direct or indirect damage, and for expenses incurred at the time of installation or during the period of use of the level sensors.

1. BASIC DESCRIPTION

Capacitive level sensors DLS® are designed for limit sensing of the level of liquid and bulk solids in tanks, sumps, tubes or, hoppers, silos, etc. The sensors are manufactured in several modifications of sensing electrodes (rod and rope). The electrodes can be given an insulating coating, a useful feature in case of adhesive, aggressive or conductive media sensing. Rod electrodes are also available in a version with reference tube for measuring fluids in tanks made from non-conductive material.

Sensors are manufactured in the following configurations: **N** – for non-explosive areas, **Xi** – Explosion proof – intrinsically safe for hazardous (explosive) areas and **XiM** – Explosion proof – intrinsically safe for use in mines with methane or flammable dust presence danger (see technical specifications). There are high temperature performance **NT**, **XiT**, **XiMT** available. DLS are offered in variants with various types of process connection (metric and pipe thread, pressure thread NPT).

2. VARIANTS OF SENSORS

- **DLS-35_-10 Uncoated short bar electrode** for sensing non-adhesive bulk solids (sand, sugar) and non-conductive liquids (petroleum products, oils), horizontal mounting.
Electrode length 50 mm or 100 mm.
- **DLS-35_-13** like DLS-35_-10, but higher pressure resistance
- **DLS-35_-20 Semi-coated rod electrode** for sensing slightly adhesive bulk solids (cement, flour) and non-conductive liquids (plant oils), horizontal, slant or vertical mounting.
Electrode length from 0.1 m to 2 m.
- **DLS-35_-21 Fully coated rod electrode (FEP insulation)** for sensing conductive liquids (water solutions, water), adhesive and aggressive materials, horizontal or vertical mounting.
Electrode length from 0.1 m to 2 m.
- **DLS-35_-22 Fully coated rod electrode (PFA insulation)** with enhanced resistance to permeation (diffusion) of vapours and gases. For sensing the level of water and other conductive liquids in the food, pharmaceutical and chemical industries. In the short term can be used for high temperature applications (e.g. hot steam sanitation), or for volatile aggressive liquids, etc. Horizontal or vertical mounting.
Electrode length 0.1 m ... 2 m.
- **DLS-35_-25** like DLS-35_-21, but higher pressure resistance at high temperature. Suitable for high temperature applications (hot steam) etc
Electrode length 0.1 m ... 2 m.
- **DLS-35_-30 Dismountable uncoated rod electrode** for sensing bulk solids and conductive or non-conductive liquids. Vertical or horizontal slant mounting.
Electrode length 0.1 m ... 3 m.
- **DLS-35_-31 Fully coated rod electrode (FEP insulation)**, for sensing aggressive conductive liquids (water, various chemicals). Vertical mounting.
Electrode length from 0.1 m to 3 m.
- **DLS-35_-40 Uncoated rod electrode with reference tube (coaxial electrode)**, for sensing non-conductive liquids (petroleum products, oil) in non-conductive tanks. Vertical mounting.
Maximum electrode length 1 m
- **DLS-35_-41 Fully coated rod electrode (FEP insulation) with reference tube (coaxial electrode)**, for sensing conductive liquids in non-conductive tanks. Vertical mounting.
Maximum electrode length 1 m.
- **DLS-35_-50 Uncoated rope electrode and weight**, for general purpose use in deeper silos (bulk solids sensing – sand, gravel, cement) or sumps (sensing liquids). Vertical mounting.
Electrode length from 1 m to 6 m.
- **DLS-35_-50 Coated rope electrode and weight (FEP insulation)**, for electrically conductive and non-conductive liquids. Maximum electrode length 10 m.

3. DIMENSIONAL DRAWINGS

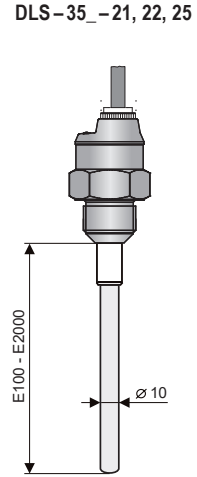
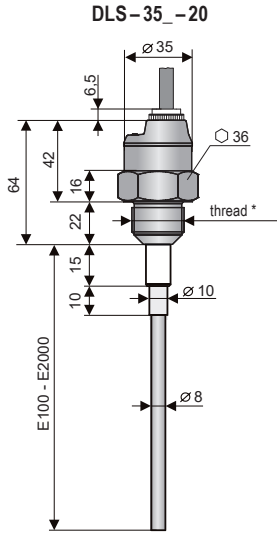
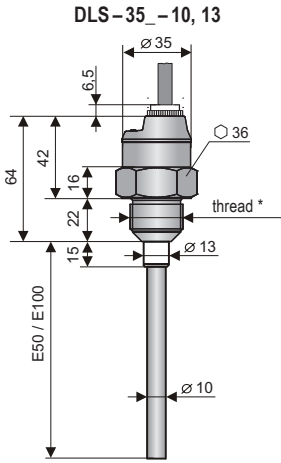

DLS-35_-30

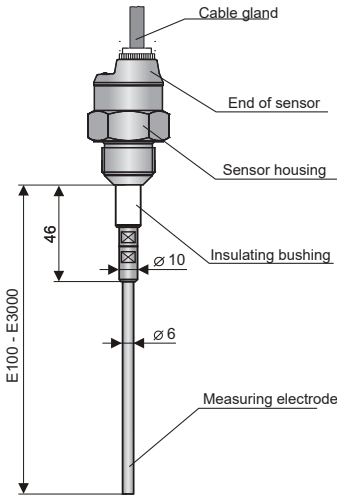

DLS-35_-31

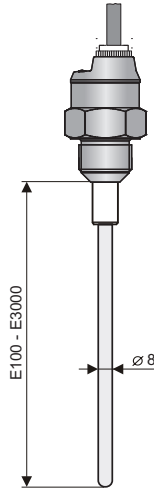

DLS-35_-50

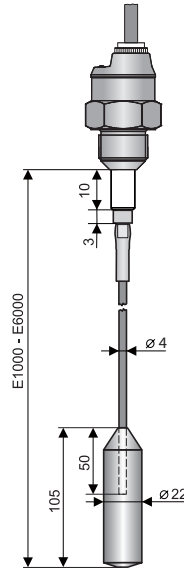

DLS-35_-52

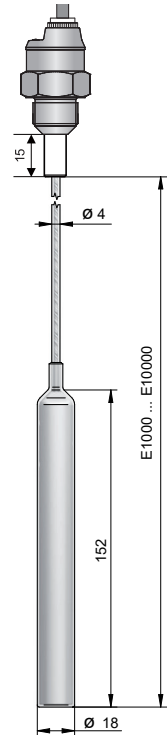

**Process connection
Tri-clamp**

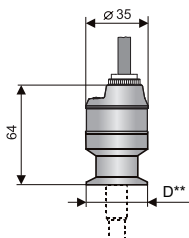

* Type of threads: G 1" G 3/4"; M27x2;
M30x1,5; NPT 3/4

** D: Tri-Clamp C134 (Ø 34 mm)
Tri-Clamp C150 (Ø 50,5 mm)

All dimensions are in mm

DLS-35_-40

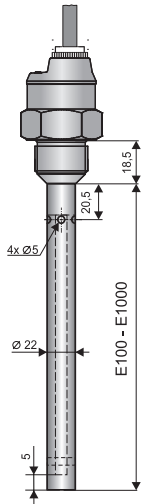

Variant "A" with short stainless steel gland

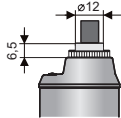

DLS-35_-41

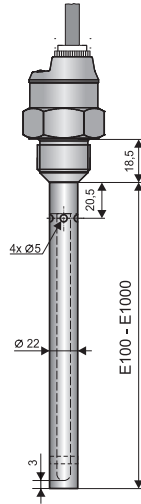

Variant "B" with plastic threaded cable gland

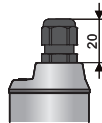

High temperatures variants

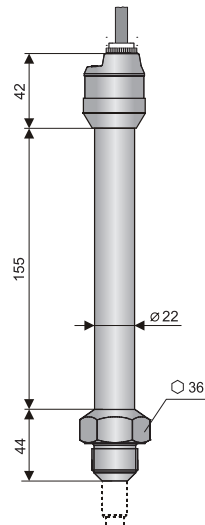

Variant "C" with connector M12

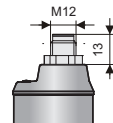

Variant "V" with plastic cable gland with spiral relief - for case of increased mechanical wear on the cable.

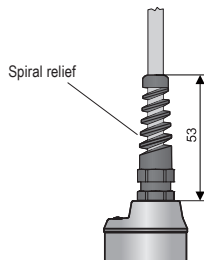

Variant "D" with dustproof cable outlet

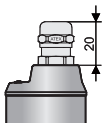

Variant "H" with cable gland for protected hoses - for using in an outdoor area or in area with increased moisture.

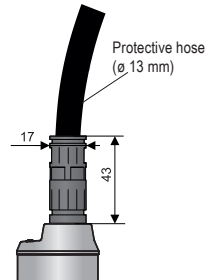

4. INSTALLATION AND PUTTING INTO OPERATION

Please follow next 3 steps:

- **INSTALLATION INSTRUCTIONS**
- **ELECTRICAL CONNECTION**
- **SETTINGS**

5. INSTALLATION INSTRUCTIONS

BASIC INFORMATION

- DLS® level sensors can be fixed in a vertical, horizontal or slanted position into the wall of a vessel, storage tank or on a fixation console in a sump by screwing into the welding flange, using a fixing nut or TriClamp® process connection.
- Basic application recommendations are mentioned below.



During assembly into the metal tank or the storage tank, it is not necessary to separately ground the base of the level sensor. In case of installation in concrete sumps or silos, it is appropriate to install the level sensor onto a metallic auxiliary construction (console, lid, etc.), and then connect to a metallic, constantly submerged object, or with steel with steel reinforcements in concrete (armouring).

In the case of the reading of an aggressive medium, we recommend that the producer be consulted



If the sensors are fitted with protective caps at the ends of the electrodes, remove the caps before commissioning.

In case of vertical mounting, sensors can be mounted into open, closed and pressurized tanks. The stated distances relate to the electrode length (longer electrode).

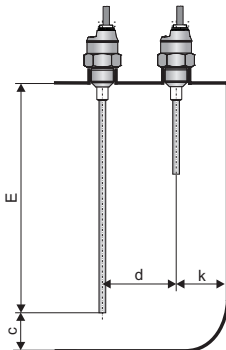

Fig. 1: Vertical mounting

All vertically mounted sensors

$$c \geq 10 + \frac{E}{50} \quad d \geq 40 + \frac{E}{40} \quad k \geq 20 + \frac{E}{20}$$

E – Electrode length in mm

In the case of **side wall mounting**, it is necessary to avoid long fitting tubes, where sensed medium could accumulate (fig. on right). We recommend mounting the sensor so that the whole sensing electrode and insulation is inside the storage tank (Figure 2 – on left).

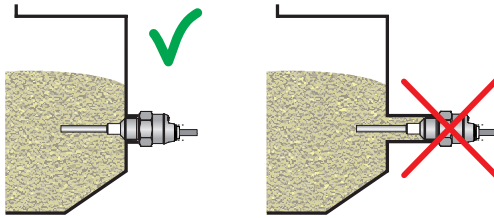

All from side mounted sensors

Fig. 2: Correct and incorrect installation with a long tube

In case of side wall mounting (Fig. 3), place the sensor outside the flow of bulk solids or liquids.

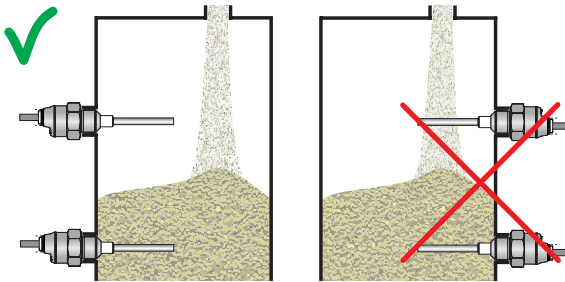

All side mounted sensors

Fig. 3: Correct and incorrect installation into storage tank side wall

Protective roof cover is recommended to prevent mechanical damage of the sensor electrode when **vertical movement of material** could damage the sensing electrode (abrasive materials, bulk-solid materials forming blocks, piece goods).

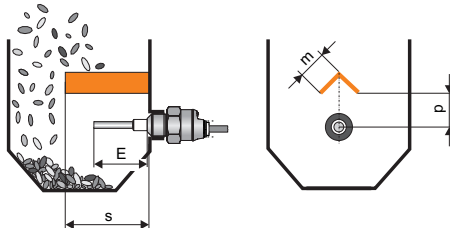

For: DLS-35_-10, 13, 20

$$s \approx \frac{4}{3}E \quad p \approx \frac{3}{4}E \quad m \approx \frac{2}{3}E$$

E- Electrode length in mm

Fig. 4: Protective roof mounting

In the case of **slant wall mounting** it is necessary to eliminate **fitting tubes**, thereby reducing medium sedimentation. The wrong example of mounting is shown in Figure 5 on the left. The appropriate mounting on the auxiliary vertical plate is shown in the middle. In some cases the variant is allowed as shown in Fig. 5 on the right. But this is recommended only for measuring bulk-solid materials by a sensor of the DLS-35_-10 type, which do not mechanically damage the electrode and do not form separate blocks.

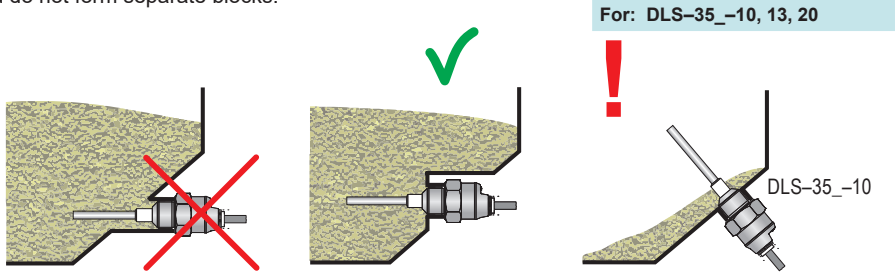

Fig. 5: Slant wall mounting

In case of **vertical installation** for sensing the level of **unknown (conductive and non-conductive) liquids** in tanks or sumps, it is appropriate to bend the electrode into a right angle. This will increase the local sensitivity and accuracy of sensing the level at the spot of the bend.

When weather conditions (wind, rain, snow) clearly influence the electrode (open sumps), we recommend using types with an insulated electrode (DLS-35_-21,22,25,31).

Plati pro typ: DLS-35_-30

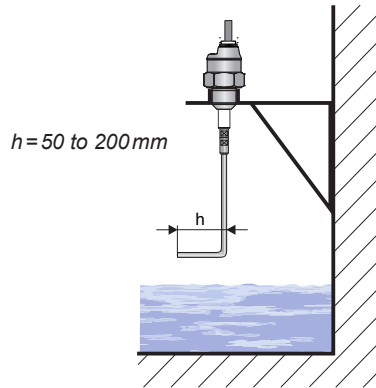

Fig. 6: Bending of the electrode end to sense unknown fluids

Mounting in a **bypass measuring tube**. We recommend upholding the tube diameter.

For types: DLS-35_-20, 21, 22, 25, 30, 31

$$b \geq 40 + \frac{E}{20}$$

E- Electrode length in mm

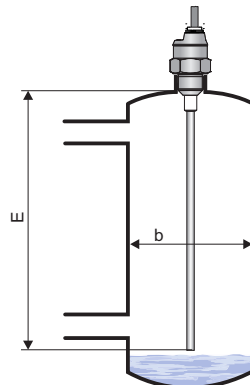

Fig. 7: Bypass measuring tube

In the case of **mounting in the pipe** it is necessary to provide the minimum distance of the inner walls from the electrode at 5 mm. In some cases (sticky liquids, low permittivity liquids) it is better to mount the sensor into a pipe bend.

For types: DLS-35_-10, 13, 21, 22, 25

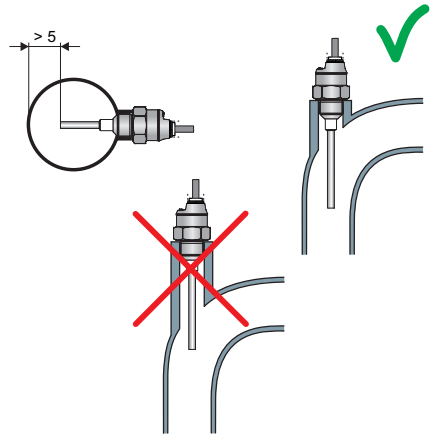

Fig. 8: Sensor mounting in a tube

In case of vertical mounting, it is possible to use the sensor for simple two-state regulation of the level height between a min. and max. value. The position of the minimum and maximum level can be changed by setting the sensor. Upon a change in the measured medium, it is necessary to perform new limit settings.

For types: DLS-35_-20, 21, 22, 25, 30, 31

E- Electrode length in mm

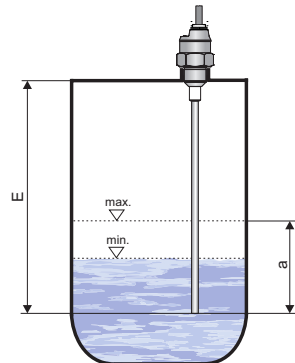

Fig. 9: Two-state level regulation by hysteresis setting

In the case of **vertical mounting** especially on existing tanks, it is necessary to select the pipe length **as short as possible** to avoid vapour condensation, or sedimentation of impurities. A similar situation occurs when the sensing electrode goes through the concrete ceiling of the silo. The hole diameter should be at least 50 mm (based on ceiling thickness).

All vertically mounted sensors

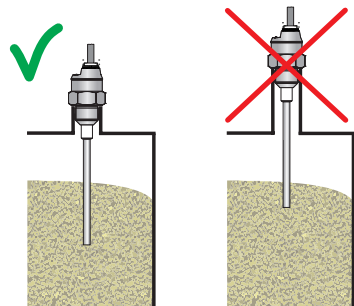

Fig. 10: Long fitting tubes in vertical mounting

6. RANGE OF APPLICATION AND INSTALLATION OF INDIVIDUAL VARIANTS

DLS-35 -10, 13

Produced in two versions – with 50 mm or 100 mm electrode. The shorter version (E50) is suitable for clean non-conductive liquids level sensing (oils, diesel, petrol, etc.). The longer version (E100) is designed for non-adhesive bulk solids or non-adhesive powder materials (plastic granulates, sand, sugar, grains, detergents, etc.) and other slightly impure, non-conductive liquids (lubricants, plant oils). The sensor is specified to be mounted directly into a vessel or storage tank wall (best by horizontal position) by means of welding flanges or stainless steel fixing nuts. In case of level sensing of low-permittivity media in non-metal storage tanks, we recommend mounting the sensor on an auxiliary metal-plate electrode with min. area of 200 cm². Variant "13" has higher pressure and mechanical resistance.

DLS-35 -20

Designed for limit level detection of bulk solids with low specific weight and permittivity (cement, hydrated lime, flour), and for materials expected to have changing properties (fly ash, sawdust, feed mixtures, etc.). It is possible to use it for sensing non-conductive liquids containing a small amount of water (up to 2%) or other impurities (plant oils, liquid propane, etc.). The sensor is mounted directly into the wall of a vessel or storage tank using steel welding flanges or fixing nuts horizontally, slanted from the side or vertically. It is recommended to mount a sensor with an electrode longer than 300 mm only in the vertical position. Hollow spaces should be minimized between the electrode and the wall where the sensed material can accumulate (see application notes). In non-metal storage tanks, we recommend mounting the sensor on an auxiliary metal-plate electrode with min. area of 400 cm².

DLS-35 -21, 22, 25

Specified for conductive liquids level sensing (water, water solutions, mud, etc.). It reacts to partial or full immersion of the electrode (depending on the adjusted sensitivity). The lower the sensitivity, the higher the sensor's resistance to contaminants and clinging remnants of material. The sensor with electrode length of up to 200 mm can be desensitized to complete water immersion, so it can be operated in the horizontal position. The sensor can be operated in the vertical position with any length up to 1 m. The sensor is mounted directly into the wall of the tank in horizontal or vertical position by applying a steel or stainless steel welding flange. For variant "22" and „25“, the material PFA is used to insulate the electrode. This variants are more resistant to vapor and gas diffusion and to volatile aggressive liquids. Variants "25" have higher pressure resistance at high temperatures and is particularly suitable for hot water, aqueous solutions and steam.

DLS-35 -30

Designed for sensing conductive and non-conductive liquids and bulk solids. It is not recommended to install the sensor into closed vessels (storage tanks) where intensive water vapour condensation occurs. The sensor reacts to electrically conductive liquids just by touch of the end of electrode. To react to a non-conductive liquid (bulk solid), it is necessary to have 5 ± 20% immersion of the electrode according to the sensor's adjusted sensitivity and permittivity of the sensed material. The sensor is mounted directly into a tank, hopper or sump in slant or vertical position by means of welding flange or stainless steel fixing nut. In non-metal storage tanks, we recommend mounting the sensor on an auxiliary metal-plate electrode with min. area of 500 cm².

DLS-35 -31

Designed for limit level detection of conductive liquids (water and solutions of various chemicals). It is possible to place the sensor electrode into closed vessels (storage tanks), open canals and sumps. The sensor reacts to the conductive fluid level after $2 \pm 20\%$ immersion of the electrode based on the sensor's set sensitivity. The sensor is mounted vertically directly into a vessel, tank or open (concrete, plastic) sumps by means of welding flanges or fixing nuts. When installing the sensor into open sumps, it is necessary to secure conductive connection of the sensor housing with the sensed liquid. It is possible to use a metal structure, armouring or another auxiliary electrode. If you must sense an aggressive medium in a closed plastic container, contact the manufacturer.

DLS-35 -40

Designed for sensing conductive and non-conductive liquids in non-metal storage tanks. It is not recommended to install the sensor into closed vessels (storage tanks) where intensive water vapour condensation occurs. The sensor reacts to electrically conductive liquids just by touch of the end of electrode. To react to non-conductive liquid, it is necessary to have $5 \pm 20\%$ immersion into a medium based on the sensitivity set on the sensor and the permittivity of the sensed material. The sensor is mounted directly into a tank, hopper or sump in slant or vertical position by means of welding flange or stainless steel fixing nut.

DLS-35 -41

Designed for sensing conductive liquids (water and water solutions of various chemicals) in non-metal storage tanks. The measuring part of the sensor can be installed into closed vessels (storage tanks), open channels and sumps. The sensor reacts to the conductive liquid level after $2 \pm 20\%$ immersion of the electrode based on the sensor's set sensitivity. The sensor is mounted vertically directly into a vessel, tank or open (concrete, plastic) sumps by means of welding flanges or fixing nuts. If you must sense an aggressive medium in a closed plastic container, contact the manufacturer.

DLS-35 -50

For sensing conductive and non-conductive liquids and bulk solids at greater depths (sewerage sumps, shafts, wells, cement storage tanks, sand, gravel, etc.). It is not appropriate to place the sensor electrode into closed containers (storage tanks) where intensive condensation of water vapour occurs. The sensor reacts to electrically conductive liquids just by touch of the end of electrode. To react to non-conductive liquid or bulk solid, a $5 \pm 20\%$ immersion into the material is necessary based on the sensitivity set on the sensor and the permittivity of the sensed material. The sensor is mounted vertically directly into the wall of a storage tank or sump. For open (concrete) sumps, it can be mounted on an auxiliary metal structure conductively connected with the sensed material. For mounting, you can use supplied welding flanges or fixing nuts.

DLS-35 -50

Designed for limit level detection of conductive liquids (water and solutions of various chemicals). It is possible to place the rope electrode into closed vessels (storage tanks), open canals and sumps. The sensor reacts to the conductive fluid level after $2 \pm 20\%$ immersion of the electrode based on the sensor's set sensitivity. The sensor is mounted vertically directly into a vessel, tank or open (concrete, plastic) sumps by means of welding flanges or fixing nuts. When installing the sensor into open sumps, it is necessary to secure conductive connection of the sensor housing with the sensed liquid. It is possible to use a metal structure, armouring or another auxiliary electrode. If you must sense an aggressive medium in a closed plastic container, contact the manufacturer.

7. ELECTRICAL CONNECTION

The positive pole of the supply voltage (+U) is connected to the brown wire BN or pin connector no.1, the negative pole (0V) is connected to the blue wire BU or pin connector no. 3 and load on the black wire BK or pin connector no. 4. The sensor assesses capacitive loads and low resistance loads (lamp) to be a short circuit.

Connection diagrams are listed in Figures 11 and 13.

Note: In case of strong ambient electromagnetic interference, paralleling of conductors with power distribution, or for the distribution to distance over 30 m, we recommend using shielded cable.

Sensors DLS-35 with type of cable outlet A, B, D, V or H are connected to assessing units permanently connected by PVC cable. Design diagrams are provided on page 7.

The sensors DLS-35 with connection method type C (see page 3) are connected to assessing units by means of a connector socket with compression cable (length 2 or 5 m), or by means of a connector socket without cable (see accessories), the connector is not part of the sensor. In this case the cable is connected to the inside pins of the socket according to the figure on the right. The recommended diameter of this cable is 4 to 6 mm (the recommended cross-sectional area is 0.5 to 0.75 mm²).

The connection of the sensor to the connecting device is performed using a suitable three wire (variant N) or two wire (variant Xi, XiT, XiM, XiMT) cable. With models Xi, XiT, XiM, XiMT, the length of the cable needs to be selected respecting the maximum permissible parameters (namely induction and capacity) of the outer spark-safe circuit of the power supplies (NSSU, NDSU, NLCU).

In the event that connector sockets that can be disassembled are used, the outer diameter of the cable is max. 6 mm.

A sensor with NPN or PNP output can be loaded only by resistive or inductive load.

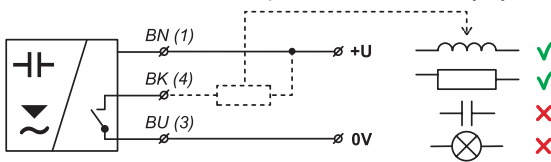

Fig. 11: NPN output type sensor connection (configuration N, NT)

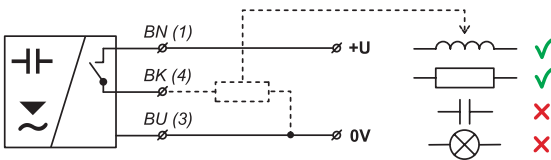

Fig. 12: PNP output type sensor connection (configuration N, NT)

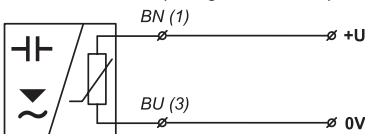

Fig. 13: Connection of a sensor with a NAMUR type output (configuration Xi, XiM, XiT, XiMT)

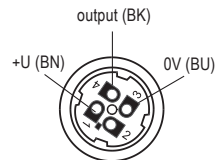

Fig. 14: Inside of the connector socket

Legend:

(1,...) – numbers of terminals inside the connector socket

BK – Black

BN – Brown

BU – Blue



Electrical connection can only be made when de-energized!

The source of the power voltage must comprise of a stabilised safe low power source with galvanic separation. In the event that a switch-mode power supply is used, it is essential that its construction effectively suppresses common mode interference on the secondary side. In the event that the switch-mode power supply is equipped with a PE safety terminal, it must be unconditionally grounded! Spark-safe devices type DLS-35Xi (XiT, XiM, XiMT) must be powered from a spark-safe power source meeting the above-mentioned requirements.



Due to the possible occurrence of an electrostatic charge on the non-conductive parts of the sensor, it is necessary to ground all sensors intended for use in environments with an explosion hazard DLS-35Xi (XiT, XiM, XiMT). This can be performed by grounding el. conductive tanks or el. conductive tank lids, and in the case of el. non-conductive tanks using and grounding an auxiliary plate electrode PDE-27.

In the event that the level meter (sensor) is installed in an outdoor environment at a distance greater than 20 m from the outdoor switchboard, or from an enclosed building, it is necessary to supplement the electrical cable leading to the level meter (sensor) with suitable overvoltage protection.

In the event of strong ambient electromagnetic interference, paralleling of conductors with power distribution, or for distribution to distances over 30 m, we recommend using a shielded cable and grounding the shielding on the side of the power source.

8. CONTROL ELEMENTS

Settings are performed by touching a magnetic pen on sensitive spots indicated as \oplus or \ominus located on the end of sensor in 4 possible modes:

1. Quick setting - the user does not know precisely to what medium the sensor should be set, he only wants to put the sensor into operation (usually upon receiving it) and check to see if the sensor is generally functional
2. Basic setting - the user has the medium available and can perform on the sensor its flooding and drainage (filling and emptying)
3. Setting of sensitivity - for additional correction of set limits - e.g. very high sensitivity can be set
4. Hysteresis setting - if the user wants to use distancing of the point of closing and opening - e.g. for two-state level regulation by using one vertically installed sensor

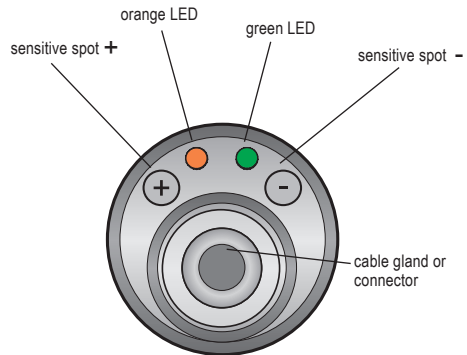



Fig. 15: Top view of sensor control elements

9. SETTINGS

9.1. QUICK SETTING

This function can be used for quick setting of the sensor, or in case it is not possible (or is very complicated) to change the level of the medium for setting the sensor. Suitable also for putting into operation.

a) Setting the mode O (It is closed when submerged)

1. The tank is empty or the level of measured medium in the tank is in a state where the sensor electrode is no longer submerged.
2. Place the magnetic pen for **at least 5 seconds*** on the sensitive spot  of the sensor (first both LEDs illuminate, after approx. 3 s the orange LED will flash 3 times, and after another approx. 2 seconds the orange LED flashes again 3 times- now you can remove the magnetic pen).

The sensor is now set to the basic mode O without the presence of medium.

b) Setting the mode C (It is open when submerged)

1. The tank is empty or the level of measured medium in the tank is in a state where the sensor electrode is no longer submerged.
2. Place the magnetic pen for **at least 5 seconds*** on the sensitive spot  of the sensor (first both LEDs illuminate, after approx. 3 s the orange LED will flash 3 times, and after another approx. 2 seconds the orange LED flashes again 3 times - now you can remove the magnetic pen).

The sensor is now set to the basic mode O without the presence of medium.





If no other agreement the mode "O" is set on all sensors straight from the factory.

9.2. BASIC SETTING



For setting sensitivity and switching mode, in case it is possible to change the level of the medium for setting the sensor.

a) Setting the mode O (It is closed when submerged)

1. Bring the level of the measured medium in the tank to a state so that the sensor electrode would be uncovered.
2. Place the magnetic pen for **at least 2 seconds**** on the sensitive spot  of the sensor until both LEDs illuminate and then remove the magnetic pen. Settings are confirmed by three flashes of the orange LED.
3. Increase the level of the measured medium in the tank up to a level where you want the sensor to detect the presence of the medium.
4. Place the magnetic pen for **at least 2 seconds**** on the sensitive spot  of the sensor (until both LEDs illuminate) and then remove the magnetic pen. Settings are confirmed by three flashes of the orange LED.
5. Check the state of indicators:
 - If the orange LED is illuminated and the green LED is flashing, the sensor is correctly set.
 - If alternating flashing of the orange and green LED occurs, the sensor did not recognize the limits for closing and opening. In this case, find out whether the minimum and maximum levels are not set too close to one another.

*) Maximum 10 seconds.

b) Setting the mode C (It is open when submerged)

1. Bring the level of the measured medium in the tank to a state so that the sensor electrode would be uncovered.
2. Place the magnetic pen for **at least 2 seconds**** on the sensitive spot  of the sensor (until both LEDs illuminate) and then remove the magnetic pen. Settings are confirmed by three flashes of the orange LED. oranžové LED.
3. Increase the level of the measured medium in the tank up to a level where you want the sensor to detect the presence of the medium.
4. Place the magnetic pen for **at least 2 seconds**** on the sensitive spot  of the sensor (until both LEDs illuminate) and then remove the magnetic pen. Settings are confirmed by three flashes of the orange LED.
5. Check the state of indicators:
 - If the orange LED is not illuminated and the green LED is flashing, the sensor is correctly set.
 - If alternating flashing of the orange and green LED occurs, the sensor did not recognize the limits for closing and opening. In this case, find out whether the minimum and maximum levels are not set too close to one another and possible repeat the settings.



For safety reasons, we recommend setting the mode "O" for level sensing (the sensor is closed upon immersion). It is for failure safety reasons – eventual failure of sensor behaves similarly as an exceeding of the limit state. Analogically, for the maximum level it is recommended to set the mode "C" (the sensor is open upon immersion).

9.3. SETTING OF SENSITIVITY

By the procedure stated in the previous chapter, limits are set for closing and opening (sensitivity of the sensor). If you want to simply increase or decrease this set sensitivity (if medium adheres to the electrode), it can be done in the following manner:

a) Increasing sensitivity

1. Place the magnetic pen for longer than 0.2 seconds but for shorter than 2 seconds on the sensitive spot  of the sensor. Settings are confirmed by three flashes of the orange LED.
2. Increasing sensitivity this way can be performed repeatedly

b) Decreasing sensitivity

1. Place the magnetic pen for longer than 0.2 seconds but for shorter than 2 seconds on the sensitive spot  of the sensor. Settings are confirmed by three flashes of the orange LED.
2. Decreasing sensitivity this way can be performed repeatedly.



9.4. HYSTERESIS SETTING

This function can be used for simple control of replenishing (draining) the level by means of a single sensor. The sensor must be placed in the vertical position and the end of the electrode must at least reach the minimum level.

a) Setting the mode Draining the level



(If the medium level reaches its maximum level, the sensor output closes. After draining the medium, when the level drops to the minimum level, the sensor output opens.)

**) Maximum 4 seconds.

1. Bring the level of the measured medium in the tank to **minimum level**.
2. Place the magnetic pen for **at least 20 seconds** on the sensitive spot  of the sensor (first both LEDs light up, after approx. 3 seconds the orange LED flashes three times and after another approx. 2 seconds the orange LED flashes again three and for a third after another 13 second the orange LED flashes - now it is possible to move the magnetic pen away).
3. Increase the level of the measured medium in the tank up to **maximum level**.
4. Place the magnetic pen for **at least 20 seconds**** on the sensitive spot  of the sensor (first both LEDs light up, after approx. 3 seconds the orange LED flashes three times and after another approx. 2 seconds the orange LED flashes again three and for a third after another 13 second the orange LED flashes - now it is possible to move the magnetic pen away).
5. Check the state of indicators:
 - If the orange LED is illuminated and the green LED is flashing, the sensor is correctly set.
 - If alternating flashing of the orange and green LED occurs, the sensor did not recognize the limits for closing and opening. In this case, find out whether the minimum and maximum levels are not set too close to one another.

b) Setting the mode Replenishing the level

(If the medium level drops to its minimum level, the sensor output closes. After replenishing the medium, when the level rises to the maximum level, the sensor output opens.)

1. Bring the level of the measured medium in the tank to **minimum level**.
2. Place the magnetic pen for **at least 20 seconds**** on the sensitive spot  of the sensor (first both LEDs light up, after approx. 3 seconds the orange LED flashes three times and after another approx. 2 seconds the orange LED flashes again three and for a third after another 13 second the orange LED flashes - now it is possible to move the magnetic pen away).
3. Increase the level of the measured medium in the tank up to **maximum level**.
4. Place the magnetic pen for **at least 20 seconds**** on the sensitive spot  of the sensor (first both LEDs light up, after approx. 3 seconds the orange LED flashes three times and after another approx. 2 seconds the orange LED flashes again three and for a third after another 13 second the orange LED flashes - now it is possible to move the magnetic pen away).
5. Check the state of indicators:
 - If the orange LED is not lit and the green LED is flashing, the sensor is set correctly.
 - If alternating flashing of the orange and green LED occurs, the sensor did not recognize the limits for closing and opening. In this case, find out whether the minimum and maximum levels are not set too close to one another.

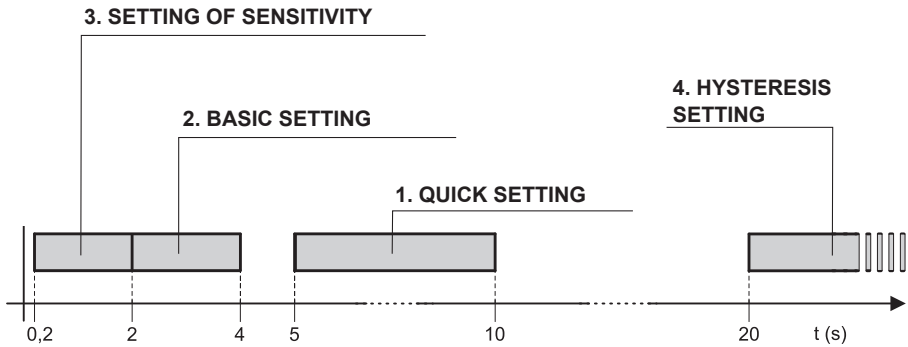
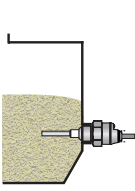

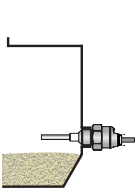

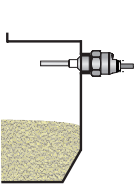

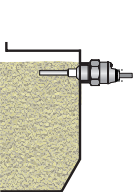



Fig. 16: Time intervals for touching the magnetic pen on the sensitive spots for individual functions of the sensor

10. FUNCTION AND STATUS INDICATION

LED indicator	colour	function
"RUN"	green	<p>Measuring function indication</p> <p>flashing – (repeats according to the period of measuring approx. 0.5 s) – correct function of level detection</p> <p>dark – incorrect installation or malfunction. LED is dark too, if the function setting is running.</p> <p>alternating flashing of the green and orange LED – error in settings (the sensor did not recognize states for open and closed).</p>
"STATE"	orange	<p>Settings indication</p> <p>permanent shine – the sensor is closed</p> <p>dark – the sensor is open</p> <p>3 short flashes – settings confirmed</p> <p>simultaneous shine of green and orange LED – when applying the mag. pen, when the setting is confirmed</p>

	level state	mode	output state	LED indicator "STATE"
minimum level sensing		O	CLOSED (with type N, NT)	 (illuminated)
			HIGHER CURRENT (with type Xi, XiT, XiM and XiMT)	
		O	OPEN (with type N, NT)	 (not illuminated)
			LOWER CURRENT (with type Xi, XiT, XiM and XiMT)	
maximum level sensing	level state	mode	output state	LED indicator "STATE"
		C	CLOSED (with type N, NT)	 (illuminated)
			HIGHER CURRENT (with type Xi, XiT, XiM and XiMT)	
		C	OPEN (with type N, NT)	 (not illuminated)
LOWER CURRENT (with type Xi, XiT, XiM and XiMT)				

11. ORDER CODE

DLS-35

MECH.ANICAL PERFORMANCE

N	non-explosive areas, cannot be used with output type R
NT	high temperature performance, cannot be used with output type R
Xi	for explosive environments ☉, only with output type R
XiM	for mining environments ☉, only with output type R
XiT	high-temperature conf. for explosive environments ☉, only with output type R
XiMT	high-temperature conf. for mining environments ☉, only with output type R

TYPE AND PERFORMANCE OF ELECTRODE

10	short bar, uncoated, lengths 50 or 100 mm
13	like 10, but higher pressure resistance
20	rod, uncoated coated, length 0.1 ... 2 m
21	rod, coated (FEP), length 0.1 ... 2 m
22	rod, coated (PFA), length 0.1 ... 2 m
25	like 21, but higher pressure and mechanical resistance at high temperatures
30	rod, uncoated coated, length 0.1 ... 3 m
31	rod, coated (FEP), length 0.1 ... 3 m
40	rod, uncoated with ref. tube, length 0.1 ... 1 m, not possible with process connection CI34 and CI50
41	rod, coated (FEP) with ref. tube, length 0.1 ... 1 m, not possible with process connection CI34 and CI50
50	rope with weight, uncoated, length 1 ... 6 m, not possible with process connection CI34 and CI50
52	coated rope electrode and weights (FEP insulation), length 1 ... 10 m.

PROCESS CONNECTION

G1	pipe thread G 1"
G3/4	pipe thread G 3/4"
M27	metric thread M 27x2
M30	metric thread M 30x1.5
NPT	pressure thread NPT 3/4
CI34	Tri-clamp (ø 34 mm)
CI50	Tri-clamp (ø 50,5 mm)

TYPE OF OUTPUT

N	NPN (open collector)
P	PNP (open collector)
R	NAMUR (change in supply current)

CONNECTION METHOD

A	stainless steel compression gland + cable
B	plastic threaded cable gland + cable
C	connector (socket not included with sensor, recommended type - see accessories)
D	metal dust proof terminal + cable
V	plastic cable gland with spiral + cable
H	plastic cable gland for protective hose + cable

ELECTRODE

E	electrode length in mm
----------	------------------------

CABLE

K	cable length in m
----------	-------------------

DLS-35

N

-

20

-

G1

-

N

-

A

E50

K5

SAMPLE OF ORDER CODE

12. CORRECT SPECIFICATION EXAMPLES

DLS-35N-10- M27-N- B E100 cable 5 m

(N) non-explosive areas; (10) uncoated short bar electrode; (M27) process connection by thread M27; (N) output type NPN; (B) plastic threaded cable gland; (E100) electrode length 100 mm

DLS-35NT-21-G3/4-P-C E580

(N) non-explosive areas; (21) coated bar electrode (FEP); (G3/4) process connection by thread G3/4"; (P) output type PNP; (C) connector; (E580) electrode length 580 mm.

DLS-35N-40-M30-P-V E1420

(N) non-explosive areas; (40) uncoated rod electrode with reference tube; (M30) process connection by thread M30; (P) output type PNP; (C) connector; (E1420) electrode length 1420 mm.

DLS-35Xi-10- M27-R- B E100 cable 5 m

(Xi) high-temperature conf. for explosive environments; (10) uncoated short bar electrode; (M27) process connection by thread M27; (R) output type NAMUR; (B) plastic threaded cable gland; (E100) electrode length 100 mm.

DLS-35N-22- CI50-P-A E200 cable 5 m

(N) non-explosive areas; (22) coated bar electrode (PFA); (CI50) process connection Tri-clamp (ø 50,5 mm); (P) output type PNP; (A) stainless steel compression gland; (E200) electrode length 200 mm.

13. ACCESSORIES

standard – included in the level sensor price

- 1 pcs. magnetic pen MP-8
- 1 pcs. seal (asbestos free) *

* Pressure resistance - see the table in the accessories datasheet in the "seals and gaskets".

optional – for a surcharge

(see catalogue sheet of accessories)

- cable (over the standard length 2m)
- connector socket (type ELWIKa or ELKA)
- normal steel welding flange or stainless steel welding flange
- protective hose (for type of cable outlet H)
- stainless steel fixing nut
- various types of seals (PTFE, AI, etc.)

14. SAFETY, PROTECTIONS, COMPATIBILITY AND EXPLOSION PROOF

The level sensor is equipped with protection against electric shock on the electrode, reverse polarity, output current overload, short circuit and against current overload on output.

Protection against dangerous contact is provided by low safety voltage according to EN 33 2000- 4- 41. Electromagnetic compatibility is provided by conformity with standards EN 55011, EN 61326-1, EN 61000-4-2 to -6, -8.

Explosion proof DLS-35Xi (XiT, XiM, XiMT) is provided by conformity with standards EN IEC 60079-0, EN 60079-11, EN 50303.

Explosion proof DLS-35Xi (XiT, XiM, XiMT) is verified FTZÚ Ostrava – Radvanice: FTZÚ 16 ATEX 0140X.

A declaration of conformity was issued for this device in the wording of Act No. 90/2016 Coll., as amended. Supplied electrical equipment matches the requirements of valid European directives for safety and electromagnetic compatibility.

Special conditions for safe use of variant DLS-35Xi (XiT, XiM, XiMT)

Connected intrinsically safe apparatus shall be galvanically separated or in the case of using the apparatus without galvanic separation (Zenner barrier) it is necessary to carry out the equalization of potentials between transducer and the place of barriers.

The version DLS-35Xi can be placed into Zone 0 or Zone 20. For the implementation DLS-35XiT the only sensing electrode can be placed into Zone 0 or Zone 20, the head with electronics can be placed only into Zone 1 or Zone 21. The maximal temperature sensing electrodes is given by temperature of measured material.

Temperature class and maximal surface temperature depends on process media temperature:

Version Xi:

Temperature class for EPL Ga:

T1 ... for maximal process media temperature $T_m = 435^{\circ}\text{C}$.

T2 ... for maximal process media temperature $T_m = 285^{\circ}\text{C}$.

T3 ... for maximal process media temperature $T_m = 190^{\circ}\text{C}$.

T4 ... for maximal process media temperature $T_m = 125^{\circ}\text{C}$.

T5 ... for maximal process media temperature $T_m = 90^{\circ}\text{C}$.

T6 ... for maximal process media temperature $T_m = 75^{\circ}\text{C}$.

MAximal surface temperature for EPL Da:

Process media temperature range is from -40°C to 300°C .

MAximal surface temperature shall be calculated as $T_{200} = T_m + 5^{\circ}\text{C}$.

Version XiT

Temperature class for EPL Ga/Gb:

T1 ... for maximal process media temperature $T_m = 435^{\circ}\text{C}$.

T2 ... for maximal process media temperature $T_m = 285^{\circ}\text{C}$.

T3 ... for maximal process media temperature $T_m = 190^{\circ}\text{C}$.

T4 ... for maximal process media temperature $T_m = 125^{\circ}\text{C}$.

T5 ... for maximal process media temperature $T_m = 90^{\circ}\text{C}$.

T6 ... for maximal process media temperature $T_m = 75^{\circ}\text{C}$.

Maximal surface temperature for EPL Da/Db:

Process media temperature range is from -40°C to 300°C.

Maximal surface temperature of EPL Da/Db part of product shall be calculated as $T_{200} = T_m + 5^\circ\text{C}$.

Version XiM, XiMT

Maximal temperature of process media is 145°C.

Equipment for application in explosive dust atmosphere must be installed in such a manner that the risk of propagating brush discharges is avoided. This restriction applies only to the part of the equipment where the label, cable gland or connector is located.

15. USE, MANIPULATION AND MAINTENANCE

The level meter does not require any personnel for its operation. Maintenance of this equipment consists in verification of integrity of the level meter and of the supply cable.



It is forbidden to make any changes or interventions to the DLS-35 sensor without the consent of the producer. Any repairs must only be carried out by the producer or authorized service organisations.

Assembly, installation, commissioning, service and maintenance of the DLS-35 level sensor must be carried out in accordance with this manual and the provisions of valid standards for the installation of electrical equipment must be complied with.

16. GENERAL, CONDITIONS AND WARRANTY

Dinel, s.r.o. guarantees for the period of three (3) years that the product has the characteristics as mentioned in the technical specification.

Dinel, s.r.o. is liable for defects ascertained within the warranty period and were claimed in writing.

This guarantee does not cover the damages resulting from misuse, improper installation or incorrect maintenance.

This guarantee ceases when the user or the other person makes any changes on the product or the product is mechanically or chemically damaged, or the serial number is not readable.

The warranty certificate must be presented to exercise a claim.

In the case of a rightful complaint, we will replace the product or its defective part. In both cases, the warranty period is extended by the period of repair.

17. MARKING OF LABELS

Labels for device of the type **DLS-35N(NT)-__-__-P-_-_-**:

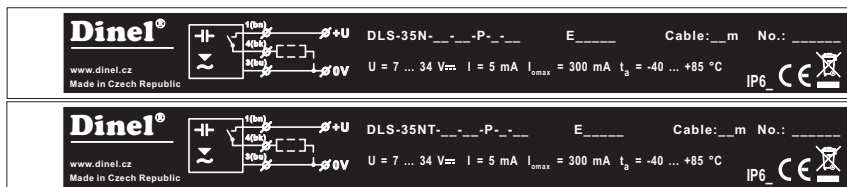

Labels for device of the type **DLS-35N(NT)-__-__-N-_-_-**:

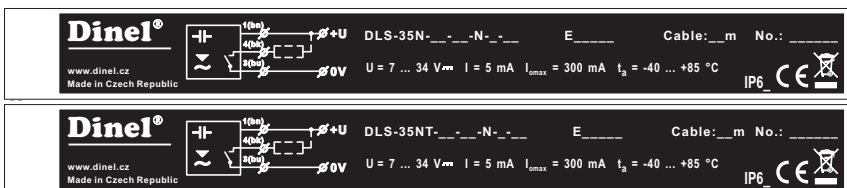

Symbol of producer: logo Dinel®

Internet address: www.dinel.cz

Country of origin: Made in Czech Republic

Connection scheme and labelling of wires: +U, 0 V

Type of level meter: DLS-35N(T)-__-__-P-_-_- , DLS-35N(T)-__-__-N-_-_- E _____

Cable length: Cable: __ m

Serial number: Ser. No.: _____ – (from the left: production year, serial production number)

Supply voltage range: $U = 7 \dots 34 \text{ V}$; Output current range: $I = 5 \text{ mA}$;



Maximum switching current: $I_{\text{max}} = 300 \text{ mA}$



Ambient temperature range: $t_a = -40 \dots +85 \text{ °C}$

Protection class: IP6_ (see. Protection class according to electrical connection)



Compliance mark: **CE**; Electro-waste take-back system mark:



Labels for device of the type **DLS–Xi(XiT)** types of electrode **10, 13, 20, 30, 40, 50**

 Dinel, s.r.o. U Tescomy 249 760 01 Zlín Czech Republic www.dinel.cz	DLS-35Xi-__-__-R-__-__ Ⓜ II 1 G Ex ia IIB T6...T1 Ga Ⓜ II 1 D Ex ia IIIC T ₂₀₀ 80°C...T ₂₀₀ 305°C Da U _i = 12 V = I _i = 15 mA P _i = 45 mW C _i = 15 nF L _i = 10 uH t _a = -40...+75 °C FTZÚ 16 ATEX 0140X	E _____	Cable: __m	No.: _____	IP6  
	Ⓜ II 1 G Ex ia IIB T6...T1 Ga Ⓜ II 1 D Ex ia IIIC T ₂₀₀ 80°C...T ₂₀₀ 305°C Da U _i = 12 V = I _i = 15 mA P _i = 45 mW C _i = 15 nF L _i = 10 uH t _a = -40...+75 °C FTZÚ 16 ATEX 0140X				



 Dinel, s.r.o. U Tescomy 249 760 01 Zlín Czech Republic www.dinel.cz	DLS-35XiT-__-__-R-__-__ Ⓜ II 1/2 G Ex ia IIB T6...T1 Ga/Gb Ⓜ II 1/2 D Ex ia IIIC T ₂₀₀ 80°C...T ₂₀₀ 305°C Da/Db U _i = 12 V = I _i = 15 mA P _i = 45 mW C _i = 15 nF L _i = 10 uH t _a = -40...+75 °C FTZÚ 16 ATEX 0140X	E _____	Cable: __m	No.: _____	IP6  
	Ⓜ II 1/2 G Ex ia IIB T6...T1 Ga/Gb Ⓜ II 1/2 D Ex ia IIIC T ₂₀₀ 80°C...T ₂₀₀ 305°C Da/Db U _i = 12 V = I _i = 15 mA P _i = 45 mW C _i = 15 nF L _i = 10 uH t _a = -40...+75 °C FTZÚ 16 ATEX 0140X				



Labels for device of the type **DLS–Xi(XiT)** types of electrode **21, 22, 25, 31, 41, 52**

 Dinel, s.r.o. U Tescomy 249 760 01 Zlín Czech Republic www.dinel.cz	DLS-35Xi-__-__-R-__-__ Ⓜ II 1 G Ex ia IIB T6...T1 Ga U _i = 12 V = I _i = 15 mA P _i = 45 mW C _i = 15 nF L _i = 10 uH t _a = -40...+75 °C FTZÚ 16 ATEX 0140X	E _____	Cable: __m	No.: _____	IP6  
	Ⓜ II 1 G Ex ia IIB T6...T1 Ga U _i = 12 V = I _i = 15 mA P _i = 45 mW C _i = 15 nF L _i = 10 uH t _a = -40...+75 °C FTZÚ 16 ATEX 0140X				

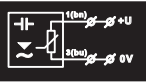
 Dinel, s.r.o. U Tescomy 249 760 01 Zlín Czech Republic www.dinel.cz	DLS-35XiT-__-__-R-__-__ Ⓜ II 1/2 G Ex ia IIB T6...T1 Ga/Gb U _i = 12 V = I _i = 15 mA P _i = 45 mW C _i = 15 nF L _i = 10 uH t _a = -40...+75 °C FTZÚ 16 ATEX 0140X	E _____	Cable: __m	No.: _____	IP6  
	Ⓜ II 1/2 G Ex ia IIB T6...T1 Ga/Gb U _i = 12 V = I _i = 15 mA P _i = 45 mW C _i = 15 nF L _i = 10 uH t _a = -40...+75 °C FTZÚ 16 ATEX 0140X				

Labels for device of the type **DLS–XiM(XiMT)**

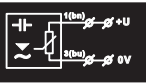
 Dinel, s.r.o. U Tescomy 249 760 01 Zlín Czech Republic www.dinel.cz	 DLS-35XiM-__-__-R-__-__ U _i = 12 V = I _i = 15 mA P _i = 45 mW C _i = 15 nF L _i = 10 uH t _a = -40...+75 °C Ⓜ I M1 Ex ia I Ma FTZÚ 16 ATEX 0140X	E _____	Cable: __m	No.: _____	IP6  
	Ⓜ I M1 Ex ia I Ma U _i = 12 V = I _i = 15 mA P _i = 45 mW C _i = 15 nF L _i = 10 uH t _a = -40...+75 °C FTZÚ 16 ATEX 0140X				

 Dinel, s.r.o. U Tescomy 249 760 01 Zlín Czech Republic www.dinel.cz	 DLS-35XiMT-__-__-R-__-__ U _i = 12 V = I _i = 15 mA P _i = 45 mW C _i = 15 nF L _i = 10 uH t _a = -40...+75 °C Ⓜ I M1 Ex ia I Ma FTZÚ 16 ATEX 0140X	E _____	Cable: __m	No.: _____	IP6  
	Ⓜ I M1 Ex ia I Ma U _i = 12 V = I _i = 15 mA P _i = 45 mW C _i = 15 nF L _i = 10 uH t _a = -40...+75 °C FTZÚ 16 ATEX 0140X				

Symbol of producer: logo Dinel®

Contact: Dinel, s.r.o., U Tescomy 249, 760 01 Zlín, Czech Republic, www.dinel.cz

Connection scheme and labelling of wires: +U, 0V

Type of level meter: DLS–35Xi(XiT)-__-__-R-__-__ E _____

DLS–35XiM(XiMT)-__-__-R-__-__ E _____

Cable length: Cable: __ m

Serial number: Ser. No.: _____ – (from the left: production year, serial production number)

Mark of non-explosive device:

version Xi, electrode types 10, 13, 20, 21, 22, 25, 30, 31, 40, 41, 50, 52:

Ⓜ II 1G Ex ia IIB T6..T1 Ga

version Xi, electrode types 10,13, 20, 30, 40, 50

Ⓜ II 1D Ex ia IIIC T₂₀₀ 80 °C ...T₂₀₀ 305 °C Da

version XiT, electrode types 10, 13, 20, 21, 22, 25, 30, 31, 40, 41, 50, 52:

Ⓜ II 1/2G Ex ia IIB T6...T1 Ga/Gb

version XiT, electrode types 10, 13, 20, 30, 40, 50:

Ⓜ II 1/2D Ex ia IIIC T₂₀₀ 80 °C ... T₂₀₀ 305 °C Da/Db

version XiM, XiMT:

Ⓜ I M1 Ex ia I Ma

Intrinsically safe parameters: U_i = 12 V =, I_i = 15 mA; P_i = 45 mW; C_i = 15 nF; L_i = 10 μH

Ambient temperature range: t_a = -40 ... +75 °C

Number of certificate of intrinsic safety: FTZÚ 16 ATEX 0140X

Protection class: IP6_ (see. Protection class according to electrical connection)

Compliance mark: , Number of authorized person supervising over the quality system: 1026

Electro-waste take-back system mark: 

 Size of labels 112 x 12 mm, the size shown does not correspond to reality.

18. TECHNICAL SPECIFICATIONS

BASIC TECHNICAL DATA

Power consumption (variant DLS-35N(T))	7 ... 34 V DC
Power consumption (variant DLS-35N(T))	max. 5 mA
Max. switching current (NPN, PNP output)	300 mA
Residual voltage – ON state	max. 1,5 V
Input resistance / electric strength	1 MΩ / 200 V DC
Coupling capacity (housing - power) / dielectric strength	50 nF / 350 V AC
Coupling capacity (electrode - power) / dielectric strength	47 nF / 350 V AC
Protection class type DLS-35-_-_-C-_-_ type DLS-35-_-_-A(B,V,H)-_-_-	IP67 IP68
Cable (versions with cable outlets)	PVC 3 x 0,5 mm ² (version N) or 2 x 0,75 mm ² (version Xi)
Weight (excl. electrode and cable)	variant N variant NT cca 0,3kg cca 0,6kg

ELECTRICAL PARAMETERS (variant Xi, XiT, XiM, XiMT)

Power supply voltage	8 ... 9 V DC
Current consumption (disconnected/ connected) – NAMUR	≤ 1 mA / ≥ 2,2 mA
Limit values	Ui = 12 VDC; Ii = 15 mA; Pi = 45 mW; Ci = 15 nF; Li = 10 μH
Reference value LC for the parameters of the used cable	typic C < 150 pF/m typic L < 0,8 μH / m

PROCESS CONNECTION

type	size	marking
Pipe thread	G 1"	G 1
	G 3/4"	G3/4
Metric thread	M27x2	M27
	M30x1,5	M30
Taper pipe thread	NPT 3/4	NPT
Jointless connection (Tri-Clamp)	ø 34 mm	CI34
	ø 50,5 mm	CI50

TYPE OF OUTPUT

Output	Variants
NPN (N)	N, NT
PNP (P)	N, NT
NAMUR (R)	Xi, XiM, XiT, XiMT

USED MATERIALS

sensor part	variants	standard material *
Wetted parts:		
Housing	all types except Tri-Clamp Tri-Clamp	stainless steel W.Nr. 1.4301 (AISI 304) stainless steel W.Nr. 1.4404 (AISI 316L)
Rod electrode	DLS-35_-10, 13 DLS-35_-20, 30, 40	stainless steel W.Nr. 1.4301 (AISI 304) stainless steel W.Nr. 1.4404 (AISI 316L)
Rope electrode	DLS-35_-50	stainless steel W.Nr. 1.4401 (AISI 316)
Reference tube	DLS-35_-40, 41	stainless steel W.Nr. 1.4301 (AISI 304)
Insulating bushing	DLS-35_-10, 20, 21, 22, 30, 31, 40, 41, 52 DLS-35_-13, 50	PTFE PPS + GF40
Electrode coating	DLS-35_-21, 25, 31, 41, 52 DLS-35_-22	FEP PFA
Sealing O-ring	DLS-35_-13	FPM (Viton)
Weight	DLS-35_-50	stainless steel W.Nr. 1.4301 (AISI 304)
Non-wetted parts:		
Cable gland	DLS-35_-_-A DLS-35_-_-B DLS-35_-_-D DLS-35_-_-V DLS-35_-_-H	stainless steel W.Nr. 1.4571 (AISI 316 Ti)/NBR plastic PA / NBR nickel-plated brass / PA / rubber CR / NBR plastic PA / NBR plastic PA / NBR
Connector M12	DLS-35_-_-C	nickel-plated brass / PA
End of sensor	all types	stainless steel W.Nr. 1.4301 (AISI 304)

** It is always necessary to verify the chemical compatibility of the material with the measured medium. You can also choose another type of material after agreement.*

WORKING AREAS AND AREA CLASSIFICATION

EN IEC 60079-0, EN 60079-11, EN 60079-10-1, EN 60079-10-2

DLS-35N	Basic performance for non-explosive atmospheres.
DLS-35NT	High-temperature basic performance for non-explosive atmospheres.
DLS-35Xi (10, 13, 20, 30, 40, 50)	Intrinsically safe explosion-proof performance for use in hazardous areas (explosive gas atmospheres or explosive atmospheres with dust) Ⓜ II 1G Ex ia IIB T6...T1 Ga; Ⓜ II 1D Ex ia IIIC T ₂₀₀ 80 °C...T ₂₀₀ 305 °C Da with intrinsically safe supply units, whole sensor zone 0 and 20.
DLS-35Xi (21, 22, 25, 31, 41, 52)	Intrinsically safe explosion-proof performance for use in hazardous areas (explosive gas atmospheres) Ⓜ II 1G Ex ia IIB T6...T1 Ga with intrinsically safe supply units, whole sensor zone 0.
DLS-35XiT (10, 13, 20, 30, 40, 50)	Intrinsically safe high-temperature explosion-proof performance for use in hazardous areas (explosive gas atmospheres or explosive atmospheres with dust) Ⓜ II 1/2G Ex ia IIB T6...T1 Ga/Gb; Ⓜ II 1/2D Ex ia IIIC T ₂₀₀ 80 °C ... T ₂₀₀ 305 °C Da/Db with intrinsically safe supply units, electrode part zone 0 and 20, head zone 1 and 21.
DLS-35XiT (21, 22, 25, 31, 41, 52)	Intrinsically safe high-temperature explosion-proof performance for use in hazardous areas (explosive gas atmospheres) Ⓜ II 1/2G Ex ia IIB T6...T1 Ga/Gb; with intrinsically safe supply units, electrode part zone 0, head zone 1.
DLS-35XiM	Intrinsically safe high-temperature explosion-proof performance for use in mines with the occurrence of methane or coal dust Ⓜ I M1 Ex ia I Ma with a safe supply units.
DLS-35XiMT	Intrinsically safe high-temperature explosion-proof performance for use in mines with the occurrence of methane or coal dust Ⓜ I M1 Ex ia I Ma with a safe supply units.

A device or part of a device intended for zone 0 can also be used in zone 1 or 2.

A device or part of a device intended for zone 1 may also be used in zone 2.

A device or part thereof intended for zone 20 may also be used in zone 21 or 22.

A device or part of a device intended for zone 21 may also be used in zone 22.

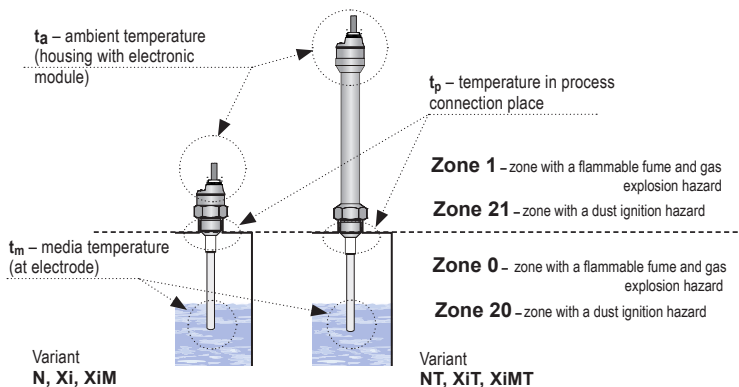

Fig. 17: Illustration of areas for temperature measurement and explosive zones

MAXIMUM MEDIUM TEMPERATURE FOR Xi(XiT) CATEGORY 1G, 1/2G	
temperature class	temperature tm
T6	+75 °C
T5	+90 °C
T4	+125 °C
T3	+190 °C
T2	+285 °C
T1	+435 °C

MAXIMUM MEDIUM TEMPERATURE FOR XiM(XiMT) CATEGORY M1	
maximum medium temperature	+ 145 °C

MAXIMUM SURFACE TEMPERATURE OF Xi(XiT) DEVICES OF CATEGORY 1D, 1/2D	
the whole device	$T_{200}=Tm + 5 °C$

TEMPERATURE RESISTANCE (versions N, NT, Xi, XiM, XiT, XiMT)			
performance	temperaturetm	temperature tp	temperature ta
DLS-35N-10	-40 °C ... +100 °C	-40 °C ... +85 °C	-40 °C ... +85 °C
DLS-35N-13	-40 °C ... +100 °C	-25 °C ... +85 °C	-40 °C ... +85 °C
DLS-35N-20, 30	-40 °C ... +300 °C	-40 °C ... +85 °C	-40 °C ... +85 °C
DLS-35N-21, 22, 25, 31, 40, 41, 52	-40 °C ... +200 °C	-40 °C ... +85 °C	-40 °C ... +85 °C
DLS-35N-50	-40 °C ... +250 °C	-40 °C ... +85 °C	-40 °C ... +85 °C
DLS-35NT-10, 20, 30	-40 °C ... +300 °C	-40 °C ... +200 °C	-40 °C ... +85 °C
DLS-35NT-13	-40 °C ... +200 °C	-25 °C ... +200 °C	-40 °C ... +85 °C
DLS-35NT-21, 22, 25, 31, 40, 41, 52	-40 °C ... +200 °C	-40 °C ... +200 °C	-40 °C ... +85 °C
DLS-35NT-50	-40 °C ... +250 °C	-40 °C ... +200 °C	-40 °C ... +85 °C
DLS-35Xi, XiM-10	-40 °C ... +100 °C	-40 °C ... +75 °C	-40 °C ... +75 °C
DLS-35Xi, XiM-13	-40 °C ... +100 °C	-25 °C ... +75 °C	-40 °C ... +75 °C
DLS-35Xi, XiM-20, 30	-40 °C ... +300 °C	-40 °C ... +75 °C	-40 °C ... +75 °C
DLS-35Xi, XiM-21, 22, 25, 31, 40, 41, 52	-40 °C ... +200 °C	-40 °C ... +75 °C	-40 °C ... +75 °C
DLS-35Xi, XiM-50	-40 °C ... +250 °C	-40 °C ... +75 °C	-40 °C ... +75 °C
DLS-35XiT, XiMT-10, 20, 30	-40 °C ... +300 °C	-40 °C ... +200 °C	-40 °C ... +75 °C
DLS-35XiT, XiMT-13	-40 °C ... +200 °C	-25 °C ... +200 °C	-40 °C ... +75 °C
DLS-35XiT, XiMT-21, 22, 25, 31, 40, 41, 52	-40 °C ... +200 °C	-40 °C ... +200 °C	-40 °C ... +75 °C
DLS-35XiT, XiMT-50	-40 °C ... +250 °C	-40 °C ... +200 °C	-40 °C ... +75 °C
DLS-35XiM, XiMT - mining environment	max. 150 °C on any surface where coal dust can form layers		

Note: For the correct operation of the level sensor, none of the here provided temperature ranges may be exceeded (tp, tm or ta).

The here-mentioned temperatures are visually explain in Fig. 17.

PRESSURE RESISTIVITY (versions N, NT, Xi, XiM, XiT, XiMT)

performance	max. operating pressure for temperature tp				
	up to 30 °C	up to 85 °C	up to 120 °C	up to 150 °C	up to 200 °C
DLS-35N-10	5 MPa (50 bar)	2,5 MPa (25 bar)	–	–	–
DLS-35N-13	7,5 MPa (75 bar)	5 MPa (50 bar)	–	–	–
DLS-35N-20, 30	5 MPa (50 bar)	2,5 MPa (25 bar)	–	–	–
DLS-35N-21, 22, 31, 40, 41	5 MPa (50 bar)	2,0 MPa (20 bar)	–	–	–
DLS-35N-25	2,0 MPa (20 bar)	2,0 MPa (20 bar)	–	–	–
DLS-35N-50	0,1 MPa (1 bar)	0,1 MPa (1 bar)	–	–	–
DLS-35N-52	1 MPa (10 bar)	0,5 MPa (5 bar)	–	–	–
DLS-35NT-10, 20, 30	5 MPa (50 bar)	2,5 MPa (25 bar)	1,5 MPa (15 bar)	1 MPa (10 bar)	0,5 MPa (5 bar)
DLS-35NT-13	7,5 MPa (75 bar)	5 MPa (50 bar)	4,5 MPa (45 bar)	4 MPa (40 bar)	3,5 MPa (35 bar)
DLS-35NT-21, 22, 31, 40, 41	5 MPa (50 bar)	2,0 MPa (20 bar)	1,5 MPa (15 bar)	1 MPa (10 bar)	0,1 MPa (1 bar)
DLS-35NT-25	2,0 MPa (20 bar)	2,0 MPa (20 bar)	2,0 MPa (20 bar)	2,0 MPa (20 bar)	2,0 MPa (20 bar)
DLS-35NT-50	0,1 MPa (1 bar)	0,1 MPa (1 bar)	0,1 MPa (1 bar)	0,1 MPa (1 bar)	0,1 MPa (1 bar)
DLS-35NT-52	1 MPa (10 bar)	0,5 MPa (5 bar)	0,2 MPa (2 bar)	0,2 MPa (2 bar)	–
DLS-35Xi,XiM-10	5 MPa (50 bar)	2,5 MPa (25 bar)	–	–	–
DLS-35Xi,XiM-13	7,5 MPa (75 bar)	5 MPa (50 bar)	–	–	–
DLS-35Xi,XiM- 20, 30	5 MPa (50 bar)	2,5 MPa (25 bar)	–	–	–
DLS-35Xi,XiM- 21, 22, 31, 40, 41	5 MPa (50 bar)	2,0 MPa (20 bar)	–	–	–
DLS-35Xi,XiM-25	2,0 MPa (20 bar)	2,0 MPa (20 bar)	–	–	–
DLS-35Xi,XiM-50	0,1 MPa (1 bar)	0,1 MPa (1 bar)	–	–	–
DLS-35Xi,XiM-52	1 MPa (10 bar)	0,5 MPa (5 bar)	–	–	–
DLS-35XiT,XiMT-10, 20, 30	5 MPa (50 bar)	2,5 MPa (25 bar)	1,5 MPa (15 bar)	1 MPa (10 bar)	0,5 MPa (5 bar)
DLS-35XiT,XiMT-13	7,5 MPa (75 bar)	5 MPa (50 bar)	4,5 MPa (45 bar)	4 MPa (40 bar)	3,5 MPa (35 bar)
DLS-35XiT,XiMT-21, 22, 31, 40, 41	5 MPa (50 bar)	2,0 MPa (20 bar)	1,5 MPa (15 bar)	1 MPa (10 bar)	0,1 MPa (1 bar)
DLS-35XiT,XiMT-25	2,0 MPa (20 bar)	2,0 MPa (20 bar)	2,0 MPa (20 bar)	2,0 MPa (20 bar)	2,0 MPa (20 bar)
DLS-35XiT,XiMT-50	0,1 MPa (1 bar)	0,1 MPa (1 bar)	0,1 MPa (1 bar)	0,1 MPa (1 bar)	0,1 MPa (1 bar)
DLS-35XiT,XiMT-52	1 MPa (10 bar)	0,5 MPa (5 bar)	0,2 MPa (2 bar)	0,2 MPa (2 bar)	–

19. PACKINGS, SHIPPING AND STORAGE

The device DLS-35 is packaged in a polyethylene bag, and the entire consignment is placed into a cardboard box. A suitable filler material is used in the cardboard box to prevent mechanical damage during transport.

Remove the device from the packaging only just before using, thereby protecting it from potential damage.

A forwarding company will be used to ship goods to the customer. Upon prior agreement, ordered goods can be picked up in person at company headquarters. When receiving, please check to see that the consignment is complete and matches the order, or to see if any damage has occurred to the packaging and device during transport. Do not use a device clearly damaged during transport, but rather contact the manufacturer in order to resolve the situation.

If the device is to be further shipped, it must be wrapped in its original packaging and protected against impact and weather conditions.

Store the device in its original packaging in dry areas covered from weather conditions, with humidity of up to 85 % without effects of chemically active substances. The storage temperature range is -10 °C to +50 °C.



All sensors except type variants DLS-35_-10, 13, 50, 52 are given protective covers at ends of electrodes (longer than 100 mm) and of reference tubes in order to prevent damage to electrode and tubes, tearing of the package or injury of persons handling them. Remove the cover prior to putting into operation.

Dinel[®]

industrial electronics

Dinel, s.r.o.
U Tescomy 249
760 01 Zlín
Czech Republic

Phone: +420 577 002 002
E-mail: sale@dinel.cz

www.dinel.cz

*Find the updated version at www.dinel.cz
version: 05/2022*

