

# RFLS-28

# Dinel®

## HIGH-FREQUENCY LEVEL SENSORS

with elimination of deposits on the electrode. RG and RN for vertical mounting, FG and FN for side mounting



CE



MIN  
-40°C



- **NEW variants FG and FN with front thread**
- **RG, RN - Installation with the tubular extender in tanks, containers, sumps or funnels and containers**
- For reliable limit level sensing of various liquids, slurries and pastes
- Resistant to adhesion of viscous and adhering media (ketchups, yoghurts, spreads, syrups, creams, pastes, cleaning agents, etc.)
- Unique material type resolution function „Medium window“ (the sensor is sensitive only to the set medium and does not react to substances with lower and higher permittivity)
- Can replace vibration level sensors
- Adjustment with a magnetic pen or by means of a setting wire (PD variant)
- Universal design for all types of liquids (electrically conductive or non-conductive)
- High stability at high sensitivity (can be used for substances with  $\epsilon_r \geq 1.5$ )
- The version with PD output now also has a diagnostic function

### Technical specifications

Supply voltage	7 ... 34 V DC
Current consumption	max. 5 mA DC
Output type	PNP (open collector)
Status indication	2x LED (orange, green)
Max. switching current (PNP output)	300 mA
Protection class	IP 68
Weight (without cable)	approx. 0.15 kg
Ambient temperature range	-40 ... +80 °C
Maximum overpressure	100 bar
Process connection	thread G 3/4", NPT 3/4"



# BASIC FEATURES AND VARIANTS

The RFLS-28 high-frequency level sensor is designed for industrial use for limit sensing of liquid and paste media. The high-frequency level sensor may be a direct replacement for a vibrating level sensor, or for a capacitive level sensor in the case of more demanding applications. The media may be electrically conductive or non-conductive with any permittivity. The sensor can be installed in metal or plastic tanks, filling tanks, sumps, etc. The RG variant can be installed using the TN-28 extension tube or in a similar way.

## Variants

code	type of sensore	o-ring
RFLS-28_-1B	<b>insulated electrode (PEEK)</b> , for various fluids, mashed and paste-like materials, also for fuel, oil or methanol	NBR
RFLS-28_-10B	<b>insulated electrode (PEEK) extended version</b> , for various liquid, mashed and paste-like materials, also for fuel, oil or methanol	NBR
RFLS-28_-1E	<b>insulated electrode (PEEK)</b> , for sensing various liquid, mashed and paste-like materials, also for acids, bases or alcohol, ammonia, acetone, chlorine	EPDM
RFLS-28_-10E	<b>insulated electrode (PEEK) extended version</b> , for various liquid, mashed and paste-like materials, also for acids, bases or alcohol, ammonia, acetone, chlorine	EPDM
RFLS-28_-1V	<b>insulated electrode (PEEK)</b> , for various liquid, mashed and paste-like materials, also for fuel, oil, acids, bases or asphalt, tar, toluene	FPM
RFLS-28_-10V	<b>insulated electrode (PEEK) extended version</b> , for various liquid, mashed and paste-like materials, also for fuel, oil, acids, bases or asphalt, tar, toluene	FPM

## Functional safety parameters

sensor variants	RFLS-28N-_-_-P	RFLS-28N-_-_-PD
According to the norm	EN 61508 ed.2	
Safety features	MIN, MAX	
SIL	2	
Hardware architecture	1oo1 without diagnostics	1oo1 with diagnostics
DC	0 %	99 %
PFH ( $T_{Proof} = 1 \text{ rok}$ ) (for the variant N)	$1,471 * 10^{-7}$	$1,471 * 10^{-9}$
$\lambda_{DD}$ (for the variant N)	0 FIT	145,6FIT
$\lambda_{DU}$ (for the variant N)	147,1 FIT	1,5 FIT
MTTF <sub>D</sub> (for the variant N)	776 years	
valid version FW	v2	v3-diagnostic

### Explanation:

SIL (Safety integrity level)

DC (Diagnostic cover)

PFH - Mean frequency of dangerous safety function error per hour,

$T_{Proof}$  - Functional check period of the safety function of the device

$\lambda_{DD/DU}$  - Intensity of dangerous detectable (or non-detectable) fault

MTTF<sub>D</sub> - Mean time to dangerous failure

## USE

The RF or RN variant of the RFLS-28 level sensor is designed for vertical installation in tanks and reservoirs.

With the TN-28 extension tube, which is available in three process connection variants (flange, G1" thread, or Tri-C-lamp), it can be extended to the required length.

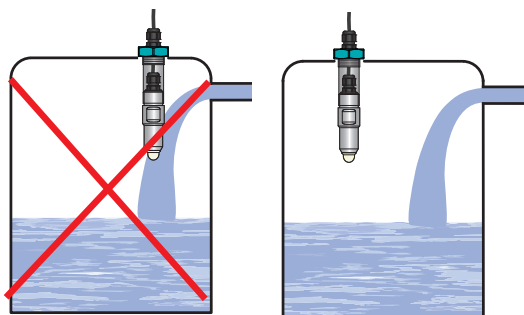

Installation of the level meter out of reach of the filling flow

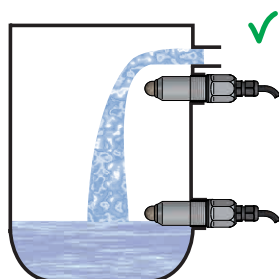

Possibility of sensor installation in the media inlet point



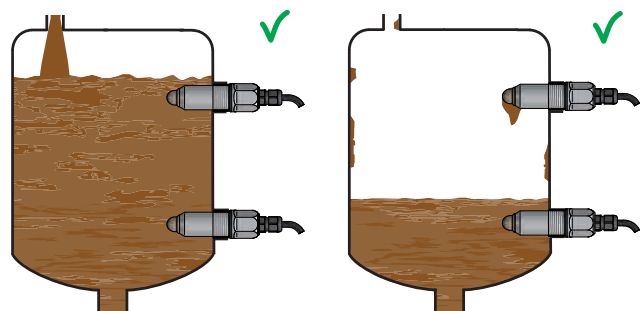

The FG and FN variants of the RFLS-35 sensor can be installed either horizontally or at an angle on the wall of the vessel, reservoir, or pipe by screwing into a weld nut or by fixing using a nut. The basic application recommendations are specified below.

Thanks to its construction, the sensor is also suitable for detecting levels of viscous and electrically conductive media (yoghurt, jams, mayonnaise, spreads, liquid soaps, creams, and pastes). After setting the sensitivity to the given medium, the sensor reliably reacts to the presence or absence of the medium level. Conversely, the sensor does not react to residues and deposits of viscous media on the measuring electrode.

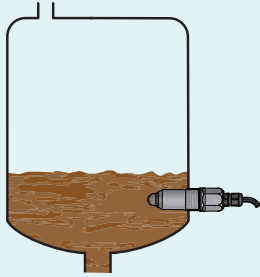
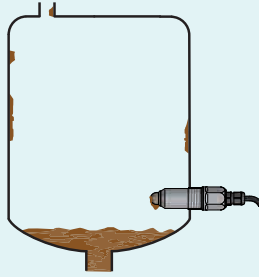
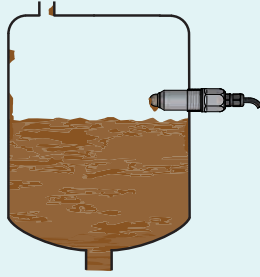
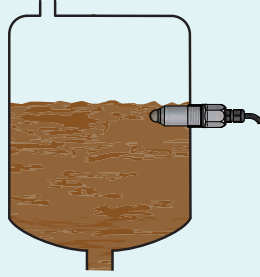

Side installation of sensors in a tank filled with viscous medium

**Settings modes for the FG, FN variants**  
 The sensor can be set to normally closed "O-mode" or to normally open "C-mode" switch types.

minimum level - mode O		maximum level - mode C	
			
CLOSED	OPEN	CLOSED	OPEN
			
illuminated	not illuminated	illuminated	not illuminated

For safety reasons, for scanning min. level, we recommend setting "O-mode" (sensor closes when submerged). A faulty sensor or wiring will take effect here in the same way as level emergency conditions by opening the sensor. Analogously, for the max. level, we recommend setting "C-mode" (sensor opens when submerged).

## DIMENSIONS

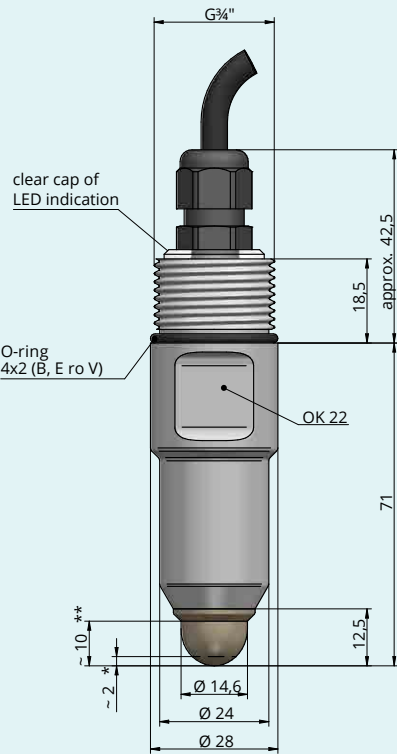
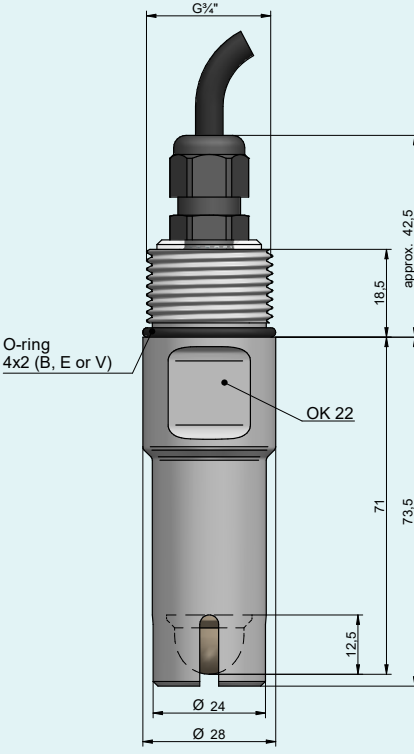
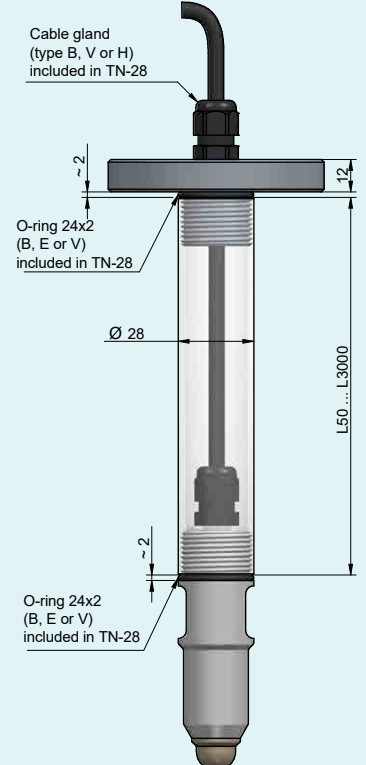
RFLS-28_-1_-RG-_-	RFLS-28_-10_-RG-_-	Extension tube TN-28-P***
		

The switching point is the same for both sensor variants.  
 \* Typical switching point position for water (factory default).  
 \*\* Typical switching point position for oil.

**\*\*\* Extension tube variants:**  
**P - flange** (in figure),  
**Z - thread G1", CI - Tri-Clamp**  
 see the accessories data sheet for the TN-28 extension tube

# DIMENSIONS

RFLS-28\_-1\_-FG-\_-

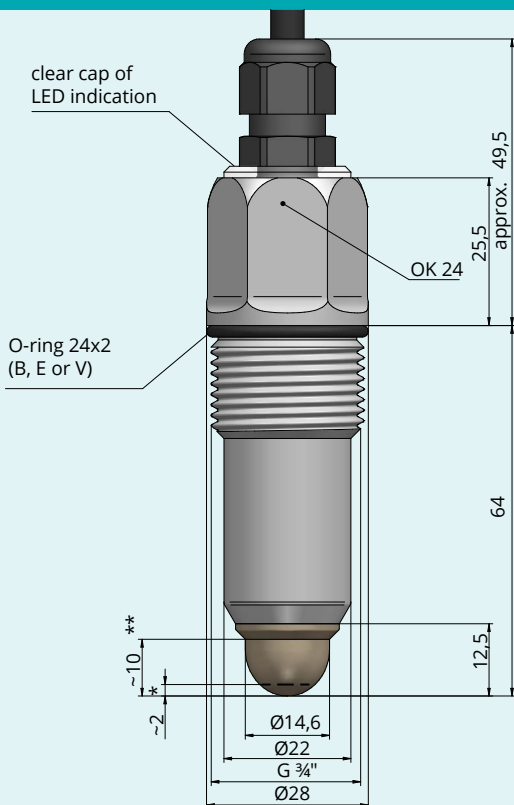

# ORDER CODE

RFLS-28

## PERFORMANCE

**N** non-explosive areas

## ELECTRODE TYPE

<b>1B</b>	coated electrode (PEEK, NBR O-ring)
<b>10B</b>	coated electrode (PEEK, NBR O-ring ) with protective crown
<b>1E</b>	coated electrode (PEEK, EPDM O-ring)
<b>10E</b>	coated electrode (PEEK, EPDM O-ring) with protective crown
<b>1V</b>	coated electrode (PEEK, FPM O-ring (Viton))
<b>10V</b>	coated electrode (PEEK, FPM O-ring (Viton)) with protective crown

## PROCESS CONNECTION

<b>FG</b>	front installation, thread $G \frac{3}{4}"$ , unavailable for 10B, 10E, and 10V type electrodes
<b>RG</b>	back installation, thread $G \frac{3}{4}"$
<b>FN</b>	front installation, NPT $\frac{3}{4}"$ , unavailable for the 10B, 10E, and 10V type electrodes
<b>RN</b>	back installation, NPT $\frac{3}{4}"$

## OUTPUT TYPE

<b>P</b>	PNP (open collector), setting using a magnetic pen
<b>PD</b>	PNP (open collector) with diagnostic1), setting using a magnetic pen or programming wire

## TYPE OF ELECTRICAL CONNECTION

<b>B</b>	standard plastic cable gland (compatible with TN-28)
<b>V</b>	standard plastic cable gland with spiral, cannot be used for TN-28
<b>H</b>	plastic cable gland for protective hose, cannot be used for TN-28





## CABLE

<b>K</b>	cable length in m
----------	-------------------

RFLS-28 N - 1B - FG - P - B K 5

EXAMPLE OF CODING

# ACCESSORIES

magnetic pen (1 pc)	included in the price	MP-8	
O-ring (NBR, EPDM, FPM/Viton), (1 pc)	included in the price		
tubular extender	at extra cost	TN-28-P (flange) TN-28-Z (G1" thread) TN-28-CI (Tri-Clamp)	
cable over 2 m	at extra cost		
protecting hose (for H cable gland)	at extra cost		