

For limit and continuous flow rate sensing of liquid media and for monitoring of their temperature

- These sensors are intended for installation in pipes, in which the actual flow rate and temperature occurs
- Flow rate measurement is shown in a bar graph by five green LED diodes and in the same graduation it is possible to select the limit for output switching (unswitching)
- Optical indication of the flow rate and temperature status via two LEDs
- Can be selected either 1x current output 4..20 mA and 1x limit PNP output, or 2x limit PNP output
- Settings provided by magnetic pen
- Stainless steel case



Thermal flow sensor - TFS-35 is a compact measuring device intended for industrial use for flow rate sensing of liquid media and for monitoring of their temperature when installed in a pipe. The sensor may be installed in plastic or metal pipes. Suitable for monitoring filling, cooling or lubricating media and their temperatures. Flow rate is indicated by means of a bar graph (5 green LEDs). Output (flow rate and temperature) switching indicator by means of LED (orange and yellow).

Simple configuration using a magnetic pen. Sensor is made in a stainless steel design. Quick and simple installation thanks to simple construction.

DIMENSIONAL DRAWING

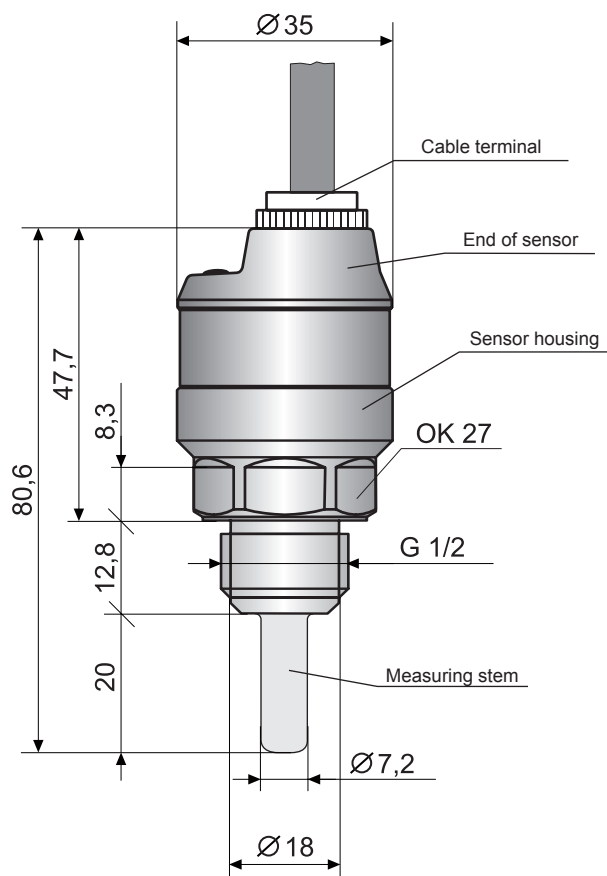

Variant "A" with short stainless steel terminal

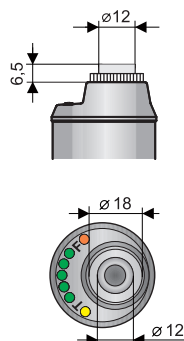

Variant "B" with plastic threaded terminal

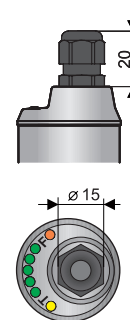

Variant "C" with connector M12

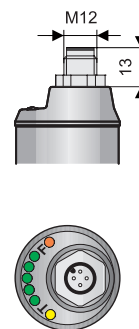

Variant "V" with plastic terminal with spiral relief – in case of increased mechanical strain on the cable.

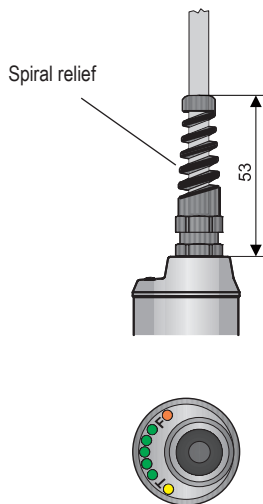

Variant "V" with plastic terminal with spiral relief – in case of increased mechanical strain on the cable.

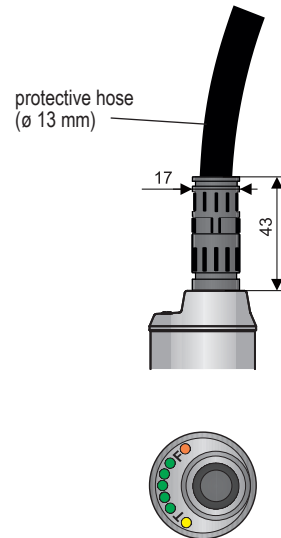

TECHNICAL SPECIFICATIONS

BASIC TECHNICAL DATA	
Working area (EN 60079-10-1)	no explosive hazard area
Supply voltage	12 ... 34 V DC
Current consumption	TFS-35N-__-PFPT-__ 60mA for supply voltage U = 24V DC 70mA for supply voltage U = 18V DC 80mA for supply voltage U = 15V DC 100mA for supply voltage U = 12V DC
	TFS-35N-__-IFPT-__ TFS-35N-__-IFPF-__ 60mA for supply voltage U = 24V DC + current loop 70mA for supply voltage U = 18V DC + current loop 80mA for supply voltage U = 15V DC + current loop 100mA for supply voltage U = 12V DC + current loop
Output	TFS-35N-__-PFPT-__ 2 x transistor PNP with open collector (Switching current - max. 300 mA, Residual voltage-ON state - max.1,5V)
	TFS-35N-__-IFPT-__ TFS-35N-__-IFPF-__ 1 x transistor PNP with open collector (Switching current - max. 300 mA, Residual voltage-ON state - max.1,5V) 1 x active current output 4 .. 20 mA.
Maximal resistance of current output load	800 Ω for supply voltage U = 24V DC 500 Ω for supply voltage U = 18V DC 200 Ω for supply voltage U = 12V DC
Indication of incorrect settings	3,75 mA at current output + indication of bargraph
Maximum switching current	300 mA
Maximum residual voltage in ON state	1,5 V
Temperature output - switching points	15 °C; 30 °C; 45 °C; 60 °C; 75 °C
Flow rate range	1 to 150 cm/s (for water)
Temperature gradient	< 250 K/min
Isolating capacity (housing - inputs) / electrical strength	4 nF / 350 V AC
Protection	IP67 (variant C) IP68 (variant A, B, V, H)
Ambient working temperature range (ta)	-20 ... +80°C
Cable	PVC 4x0,5 mm ²
Heat up time after start	10s
Response time	2 to 15s ^{*1)}
Pressure strength	10 MPa (100 bar) over full temperature range
Weight of sensor (without cable)	150 g

*1) Depending on the flow rate and setting of the sensor.

USED MATERIALS

part of the sensor	type	standard material
Housing (including measur. stem)	all	stainless steel W.Nr. 1.4404 (AISI 316L)
End of sensor	all	stainless steel W.Nr. 1.4301 (AISI 304)
Cable terminal	TFS-35_ _ _ _ _ A- L_ _ TFS-35_ _ _ _ _ B- L_ _ TFS-35_ _ _ _ _ V- L_ _ TFS-35_ _ _ _ _ H-L_ _	stainless steel W.Nr. 1.4571 / NBR plastic PA / NBR plastic PA / NBR plastic PA / NBR
Connector M12	TFS-35_ _ _ _ _ C-L_ _	nickel-plated brass

PROCESS CONNECTION

name	dimensions	marking
pipe thread	G 1/2"	G 1/2

ELECTRICAL CONNECTION



Electrical connection can only be made in a voltage-free state!

A sensor with PNP type of outputs can be loaded only by resistive or inductive loads. The positive pole of the supply voltage (+U) is connected to the brown wire *BN* or *pin connector no.1*, the negative pole (0 V) is connected to the blue wire *BU* or *pin connector no.3*. Flow rate load on the black wire *BK* or *pin connector no.4* and temperature load on the white wire *WH* or *pin connector no.2*. The capacitive loads and low resistance loads (e.g. bulb) are evaluated by the sensor as a short circuit.

Wiring diagrams are provided in the figures below.

Flow sensor TFS-35 with a type A, B, V or H cable terminal, is connected to the assessment units permanently by a connection cable, see. Dimensional drawings.

The TFS-35 flow sensor with connection method type C (see Dimensional drawings) is connected to the assessment units by means of a connector socket with a pressed-in cable, or by means of a detachable connector socket without a cable (e.g. ELWIKA), see accessories. In this case the cable is connected to the inside pins of the socket according to the figure below. The recommended diameter of this cable when using ELWIKA connectors is 4 to 6 mm (the recommended wire cross-sectional area is 0.5 to 0.75 mm²).

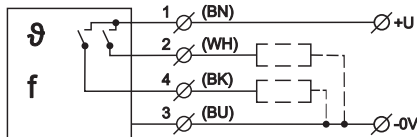

Connection of flow sensor TFS-35_ _ _ -PFPT

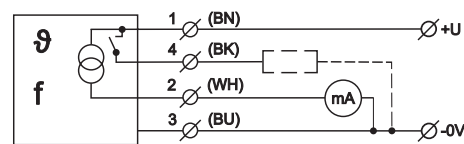

Connection of flow sensor
TFS-35_ _ _ -IFPF and TFS-35_ _ _ -IFPT

Connection of outputs in variant PFPT

Limit flow rate output - black wire of cable (BK),
- or pin 4 of connector.

Limit temperature output - white wire of cable (WH),
- or pin 2 of connector.

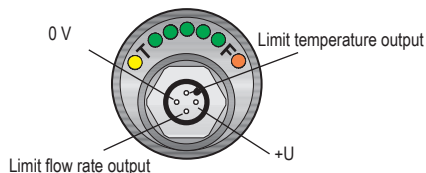

Connector of flow sensor TFS-35_ _ _ -PFPT

Connection of outputs in variant IFPF (IFPT)

Analog flow rate output - white wire of cable (WH),
- or pin 2 of connector.

Limit flow rate (temper.) output - black wire of cable (BK),
- or pin 4 of connector..

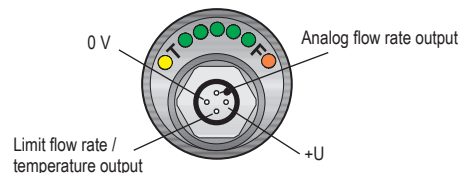

Connector of flow sensor
TFS-35_ _ _ -IFPF and TFS-35_ _ _ -IFPT

Legend:

BN – brown
WH – white
BK – black
BU – blue

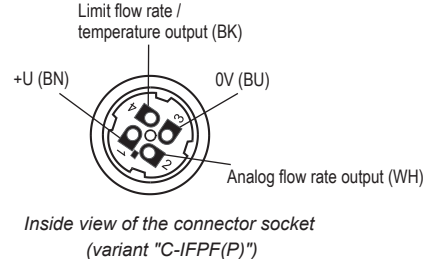
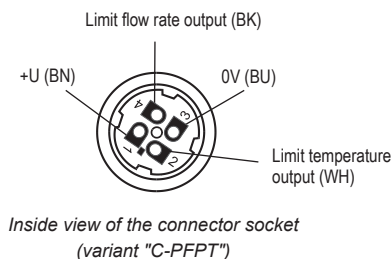

SETTINGS

Settings are performed by placing the magnetic pen on to the sensitive spot marked "T" or "F" located between the LEDs. In this way, the minimum and maximum flow rate, flow rate switching point, temperature switching point, switching modes (O, C) are set or the factory setting are restored. An incorrect setting is indicated by the green LEDs gradually turning on and off, going from the centre to the edges.

Information on settings of the sensor is provided in the user's manual.

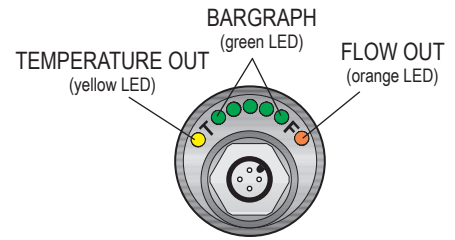

FUNCTION AND STATUS INDICATION

signal	colour	function
"FLOW OUTPUT"	orange	<p>Flow rate output status indicator permanently shine - output is switched dark - output is unswitched Maximum flow rate setting light with gradual lighting of green LEDs - maximum flow rate is being set 3 flashes - confirmation that settings are saved</p>
"BARGRAPH" (5 LED)	green	<p>Flow rate indicator gradual lighting up of LEDs from left to right - depending on the flow rate range settings incorrect setting - gradual turning on and off, going from the centre to the edges Flow rate / temperature switching point settings one LED is permanently shine - when this point is reached, the flow rate / temperature output is switched / unswitched</p>
"TEMPERATURE OUTPUT"	yellow	<p>Temperature output status indicator permanently shine - output is switched dark - output is unswitched Minimum flow rate setting light with gradual lighting of green LEDs - maximum flow rate is being set 3 flashes - confirmation that settings are saved</p>

ORDER CODE

<p>Mech. performance: _____ N – non-explosive areas</p> <p>Type of stem: _____ 10 – bare cylindrical</p> <p>Process connection place: _____ G1/2 – pipe thread G 1/2"</p>	<p>TFS-35 [] - [] - [] - [] - [] - []</p> <p>L [] [] cable – cable length in m</p> <p>Stem length (in mm): 20 (20 mm)</p> <p>Connection method: A – stainless steel press-in terminal (+ cable length) B – plastic threaded terminal (+ cable length) C – connector (socket not included with sensor, recommended type - see accessories.) V – plastic terminal with a spiral (+ cable length) H – plastic terminal for protective hose (+ cable length)</p> <p>Type of output:</p> <p>PFPT – 1. output – Limit flow rate output (transistor PNP with open collector) 2. output – Limit temperature output (transistor PNP with open collector)</p> <p>IFPF – 1. output – Limit flow rate output (current 4 .. 20 mA) 2. output – Limit flow rate output (transistor PNP with open collector)</p> <p>IFPT – 1. output – Limit flow rate output (current 4 .. 20 mA) 2. output – Limit temperature output (transistor PNP with open collector)</p>
---	---

CORRECT SPECIFICATION EXAMPLES

TFS-35N-10-G1/2-PFPT-A-L20 cable 2 m

(N) configuration for normal areas; (10) non-insulated cylindrical; (G1/2) process connection with thread G1/2"; (PFPT) PNP type flow rate and temperature sensing terminals; (A) stainless steel cable terminal; (L20) length of stem 20mm; cable 2 m.

TFS-35N-10-G1/2-PFPT-C-L20

(N) configuration for normal areas; (10) non-insulated cylindrical; (G1/2) process connection with thread G1/2"; (PFPT) PNP type flow rate and temperature sensing terminals; (C) M12 connector; (L20) length of stem 20mm.

TFS-35N-10-G1/2-PFPT-B-L20 cable 12 m

(N) configuration for normal areas; (10) non-insulated cylindrical; (G1/2) process connection with thread G1/2"; (PFPT) PNP type flow rate and temperature sensing terminals; (B) plastic cable terminal; (L20) length of stem 20mm; cable 12 m.

ACCESSORIES

standard - included in the flow sensor price

- 1 pcs. magnetic pen MP-8

optional – for a surcharge (see catalogue sheet of accessories)

- cable (over the standard 2m length)
- connector socket (type ELWIKa or ELKA)
- standard steel or stainless steel welding flange
- protective hose (for type of cable terminal H)
- stainless steel fixing nut
- various types of seals (PTFE, Al, etc.)

SAFETY, PROTECTION AND COMPATIBILITY

The flow sensor TFS-35 is equipped with protection against voltage polarity reversal, protection against current overload and protection against short term overvoltage.

Protection against dangerous contact is provided by low safety voltage according to 33 2000-4-41.

Electromagnetic compatibility is provided by conformity with standards EN 55011 / B, EN 61326-1, EN 61000-4-2 (8 kV), -4-3 (10 V/m), -4-4 (2 kV), -4-5 (1 kV) and -4-6 (10 V).

PACKAGING, SHIPPING AND STORAGE

The TFS-35 device is supplied packaged in a cardboard box that protects it against mechanical damage.

When handling and during transport, it is necessary to prevent impacts and falls.

The TFS-35 electrical device must be stored in dry enclosed areas with humidity up to 85%, free of aggressive vapours at temperatures between -10°C and 50°C, and must be protected against the effects of weather.