

- For continuous measurement of liquids in non-pressure tanks, vessels and pipes
- Intended for various liquids (water, oil, coolants, water solutions, etc.)*
- High long-term stability
- Accuracy 0,5% within the total range
- Measuring range up to 100 m (H₂O)
- Thread process connection
- Current or voltage output
- LED indicators
- Variant with an option of settings with a magnetic pen within the selected range



The hydrostatic level meter HLM-35 is a compact measuring device containing a ceramic or stainless steel strain gauge sensor and evaluation electronics in a stainless steel probe. The ceramic sensor is resistant to different against various liquids (water, oil, coolants, water solutions, etc.). The probe is produced in a configuration with a valve or a capillary, which serves to deliver atmospheric pressure to the probe. The front side of the probe is open, which makes the level meter more resistant against adhesion of coarser soiling. The level meter does not include any elements that can be set. LED signal function.

VARIANTS OF SENSORS

- **HLM-35N-CV** **measuring range 1 ... 100 m H₂O, arbitrary** standard measuring range (can be custom set in 10 cm increments). In case of the variant with an option of settings with a magnetic pen, the range is user-adjustable within the selected measuring range. Current (4 ... 20 mA) or voltage (0 ... 10 V) output. **Sensor with ceramic** converter membrane. **Pressure equalisation via a valve.**
- **HLM-35N-CK** **measuring range 1 ... 100 m H₂O, arbitrary** standard measuring range (can be custom set in 10 cm increments). In case of the variant with an option of settings with a magnetic pen, the range is user-adjustable within the selected measuring range. Current (4 ... 20 mA) or voltage (0 ... 10 V) output. **Sensor with ceramic** converter membrane. **Pressure equalisation via a capillary.**
- **HLM-35N-SV** **measuring range 1 ... 100 m H₂O, arbitrary** standard measuring range (can be custom set in 10 cm increments). In case of the variant with an option of settings with a magnetic pen, the range is user-adjustable within the selected measuring range. Current output (4 ... 20 mA). **Sensor with stainless steel** converter membrane. **Pressure equalisation via a valve.**
- **HLM-35N-SK** **measuring range 1 ... 100 m H₂O, arbitrary** standard measuring range (can be custom set in 10 cm increments). In case of the variant with an option of settings with a magnetic pen, the range is user-adjustable within the selected measuring range. Current output (4 ... 20 mA). **Sensor with stainless steel** converter membrane. **Pressure equalisation via a capillary.**

* In case of using the level gauge on a liquid other than H₂O, it is necessary to correct the output current or voltage depending on the density of the measured or use the user-adjustable version with a magnetic pen.

DIMENSIONAL DRAWING

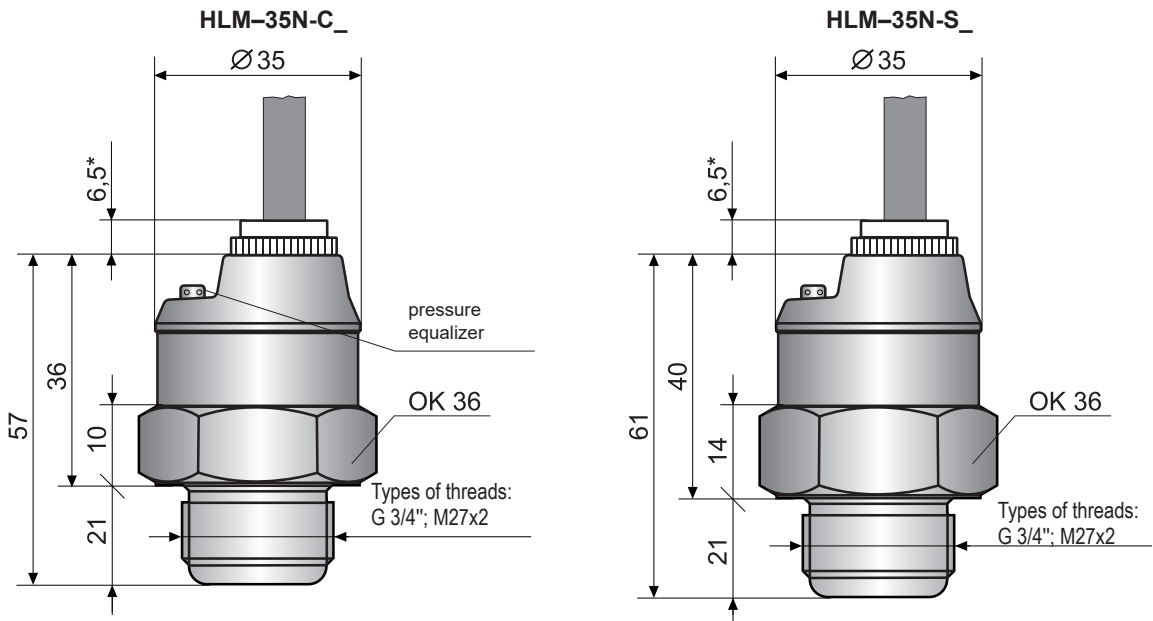

* According to el. connection type

Variant "A" with short stainless steel terminal

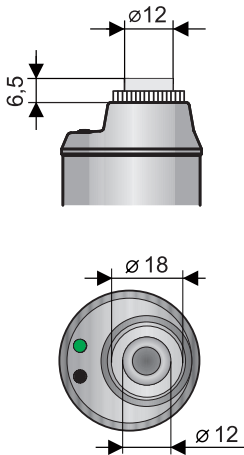

Variant "B" with plastic threaded terminal

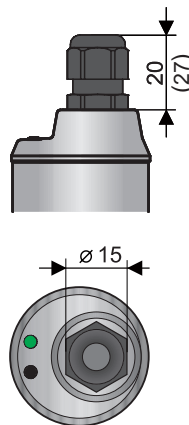

Variant "C" with connector M12

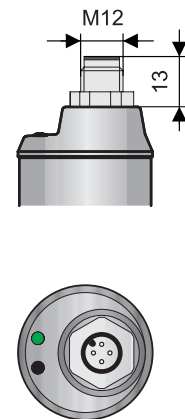

Variant "V" with plastic terminal with spiral relief – in case of increased mechanical strain on the cable.

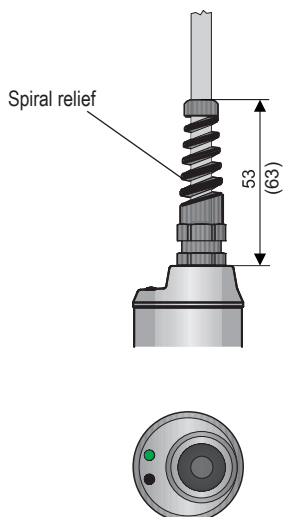

Variant "H" with terminal for protected hoses – for use in outdoor environments or in areas with increased moisture.

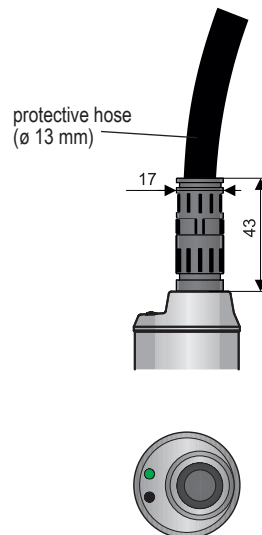

Note. Values in brackets apply for version with the capillary (CK and SK)

TECHNICAL SPECIFICATIONS

BASIC TECHNICAL DATA		
Working environment (EN 60079-10-1)		no explosive hazard area
Supply voltage	HLM-35 _ _ _ _ -I- _ _ _ _ HLM-35 _ _ _ _ -U- _ _ _ _	12 ... 34 V DC 12 ... 34 V DC
Current output	HLM-35 _ _ _ _ -I- _ _ _ _	4 ... 20 mA
Voltage output	HLM-35 _ _ _ _ -U- _ _ _ _	0 ... 10 V
Consumption (empty voltage output)	HLM-35 _ _ _ _ -U- _ _ _ _	max. 8 mA
Permissible overload		1.5x of range
Basic accuracy (non-linearity, hysteresis, repeatability)		0.5% of range
Long-term stability		0.3% / year
Temperature error for zero and range between 0 ... +50°C		max. 0.04% / K
Temperature compensation range		0 ... +50°C
Operating temperature range (temperature of the media)		-20 ... +70 °C
Max. load resistance for current output (at U = 24 V DC)		$R_{max} = 600 \Omega$
Min. load resistance for current output		$R_{min} = 1 k\Omega$
Protection class	type HLM-35 _ _ _ _ -C- _ _ _ _ type HLM-35 _ _ _ _ -(A,B,V,H)- _ _ _ _	IP67 IP68
Cable	type HLM-35 _ _ V- _ I- _ _ _ _ type HLM-35 _ _ V- _ U- _ _ _ _ type HLM-35 _ _ K- _ I- _ _ _ _ type HLM-35 _ _ K- _ U- _ _ _ _	PVC 2 x 0.75 mm ² PVC 3 x 0.5 mm ² PE 2 x 0.25 mm ² with capillary PE 3 x 0.25 mm ² with capillary
Weight	sensor cable (1 m)	190 g 60 g

USED MATERIALS		
part of the sensor	type	standard material
Housing	all	stainless steel W.Nr. 1.4404 (AISI 316L)
End of sensor	all	stainless steel W.Nr. 1.4301 (AISI 304)
Membrane	HLM-35 _ CV- _ _ _ _ HLM-35 _ CK- _ _ _ _ HLM-35 _ SV- _ _ _ _ HLM-35 _ SK- _ _ _ _	ceramic Al ₂ O ₃ 96% ceramic Al ₂ O ₃ 96% stainless steel stainless steel
Gasket O-rings	all	FPM (Viton)
Cable terminal	HLM-35 _ _ _ _ -A- _ _ _ _ HLM-35 _ _ _ _ -B- _ _ _ _ HLM-35 _ _ _ _ -V- _ _ _ _ HLM-35 _ _ _ _ -H- _ _ _ _	stainless steel W.Nr. 1.4301 (AISI 304) plastic PA / NBR plastic PA / NBR plastic PA / NBR
Connector M12	HLM-35 _ _ _ _ -C- _ _ _ _	nickel-plated brass

PROCESS CONNECTION		
name	dimensions	marking
pipe thread	G 3/4"	G
Metric thread	M27x2	M27

RANGE OF APPLICATION

For continuous level measurement of clean, lightly soiled or turbid water in non-pressure vessels. Further for various liquids (oil, coolants, etc.). If the level meter is used on a liquid other than water, it is necessary to make correction of output current (resp. voltage) according to the density of measured liquid. We recommend consulting the suitability of the level meter for measuring other liquids, than H₂O with the manufacturer.

INSTALLATION INSTRUCTIONS

- Installation by screwing into the wall of the vessel of the measured area.
- When using the cable containing the equalising **capillary**, it is necessary to use a **non-hermetic** connection box for connection to connecting cables.
- For CK and SK type level meter, when winding up excess cable into rolls, a diameter of min. 30 cm must be maintained. We do **not recommend** shortening or otherwise mechanically adjusting the cable.
- In tanks, where swirling of the liquids occurs as a result of strong inflow or mixing, it is necessary to place the probe in a stilling pipe, behind a partition or at least as far away as possible from the source of the swirling.
- When using it for **liquids other than water**, it is necessary to make a **correction** to the output voltage respecting the density of the measured liquid, and if necessary consult the application with the manufacturer.

ELECTRICAL CONNECTION



Electrical connection can only be made in a voltage-free state!

In the event that the level meter is fitted with a shielded cable, it is necessary to ground the cable on the side of the power source for the event of a possible lightning electrical discharge in the vicinity of the sensor.

In the event that the level meter is installed in an outdoor environment at a distance greater than 20 m from the outdoor switchboard, or from an enclosed building, it is necessary to supplement the electrical cable leading to the level meter with suitable overvoltage protection.

In case of strong ambient electromagnetic interference, paralleling of conductors with power distribution, or for distribution to distances over 30m, we recommend using a shielded cable and its grounding on the side of the power source.

Level meters HLM-35 with a type A, B, V or H cable terminal, are connected to the assessment units permanently by a connection cable, see pg. 2.

Level meters HLM-35 with connection method type C (see pg. 2) are connected to assessing units by means of a connector socket with a press-in cable, or by means of a detachable connector socket without a cable (see accessories), the connector is not part of the sensor. In this case the cable is connected to the inside pins of the socket according to the figure below.

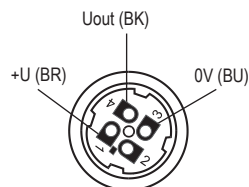

Inside view of the connector socket (variant "C")

In case of use **cable with capillary** connect the positive pole (+U) of the power supply to the red wire *RD*, or connector pin no. 1, the negative pole (0 V) to the blue wire *BU*, or connector pin no. 3, and the output voltage (U_{out}) to the black wire *BK*, or connector pin no. 4. Connection diagrams are provided in the figures below.

In case of use **cable without capillary** connect the positive pole (+U) of the power supply to the brown wire *BR*, or connector pin no. 1, the negative pole (0 V) to the blue wire *BU*, or connector pin no. 3, and the output voltage (U_{out}) to the black wire *BK*, or connector pin no. 4. Connection diagrams are provided in the figures below.

Level meter connection with current output

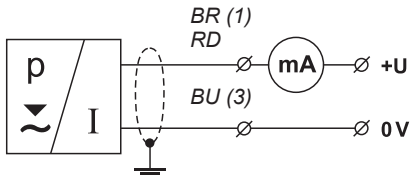

(X) – Connector terminal numbers

Cable wire colours with a pressed connector:

BR – brown
BU – blue

Cable wire colours with capillary:

RD – red
BU – blue
---- – shielding

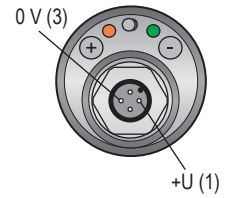

Level meter connection with current output

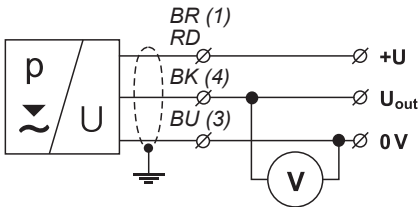

(X) – Connector terminal numbers

Cable wire colours with a pressed connector:

BR – brown
BK – black
BU – blue

Cable wire colours with capillary:

RD – red
BU – blue
BK – black
---- – shielding

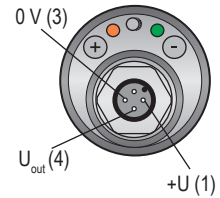

SETTINGS FOR THE USER-ADJUSTABLE VARIANT

The measuring range is set by touching sensitive spots “-” and “+” with the magnetic pen. The sensitive spot “-” is used to enter the setting mode to set the limit of 4 mA (0 V) and reduce the current (voltage) to be set. After reaching the required current (voltage), wait for steady orange LED light and, then, touch the sensitive spot “-” with the magnetic pen to confirm the set value. The sensitive spot “+” is used to enter the setting mode to set the limit of 20 mA (10 V) and increase the current (voltage) to be set. After reaching the required current (voltage), wait for steady orange LED light and, then, touch the sensitive spot “+” with the magnetic pen to confirm the set value. The setting progress is indicated by the orange “STATE” indicator. The correct level measurement function is indicated by the green “RUN” indicator.

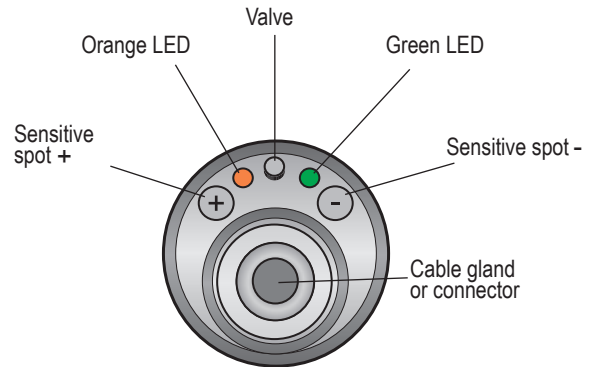

Top view of the level meter

FUNCTION AND STATUS INDICATION

Indicator	Colour	Function
"RUN"	Green	Measuring function indication
		Flashing – (repeats in approx. 0.5 s according to measurement period) – proper level measurement function
		Dark – incorrect installation or malfunction. In addition, the LED indicator is dark in the limit setting mode.
"STATE"	Orange	Alternating flashing of green and orange LEDs – incorrectly set limits
		Settings indication
		Slow flashing – 4 mA (0 V) limit setting signalling
		Fast flashing – 20 mA (10 V) limit setting signalling
		Permanent shine – the level meter is ready to confirm the limit setting using the magnetic pen
		3 short flashes – confirmation of the settings
		The simultaneous shine of green and orange LEDs – when touching the magnetic pen to confirm the limit setting

CONNECTION EXAMPLES

CONNECTION OF LEVEL METER HLM-35-C-I WITH CURRENT OUTPUT TO THE UNIT PDU-4xx-P (OUTPUT 4 ... 20 mA) USING JUNCTION BOX NB

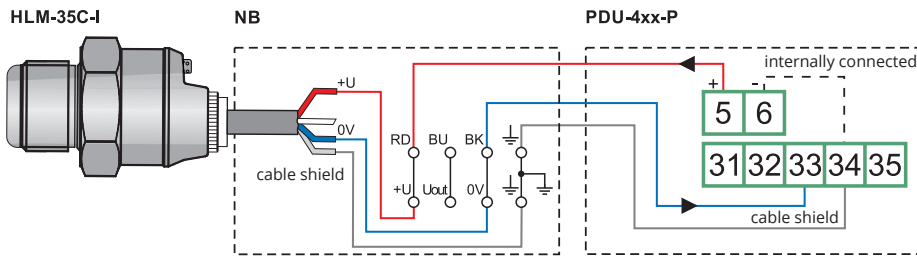

In the case using a connection box with integrated overvoltage protection, the sensor needs to be connected to the bottom series of terminals. This series of contacts is marked by label SENSOR.

CONNECTION OF LEVEL METER HLM-35-C-U WITH VOLTAGE OUTPUT TO THE UNIT PDU-4xx-P (OUTPUT 0 ... 10 V) USING JUNCTION BOX NB

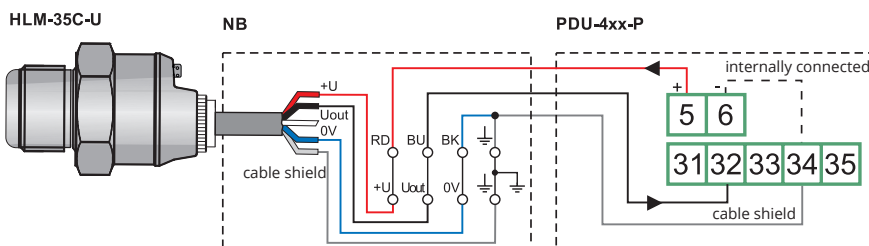

In the case using a connection box with integrated overvoltage protection, the sensor needs to be connected to the bottom series of terminals. This series of contacts is marked by label SENSOR.

CONNECTION OF LEVEL METER HLM-35-C-I WITH CURRENT OUTPUT TO THE UNIT PDU-4xx-W (OUTPUT 4 ... 20 mA) USING JUNCTION BOX NB

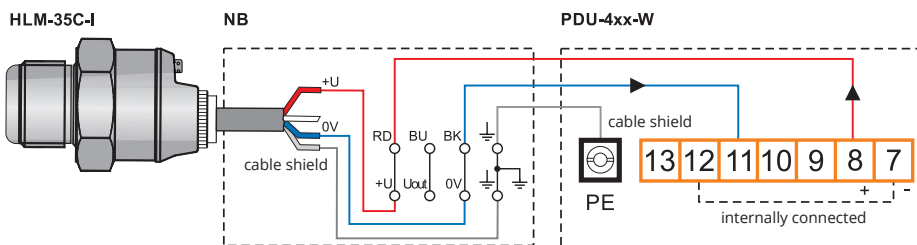

In the case using a connection box with integrated overvoltage protection, the sensor needs to be connected to the bottom series of terminals. This series of contacts is marked by label SENSOR.

CONNECTION OF LEVEL METER HLM-35-C-U WITH VOLTAGE OUTPUT TO THE UNIT PDU-4xx-W (OUTPUT 0 ... 10 V) USING JUNCTION BOX NB

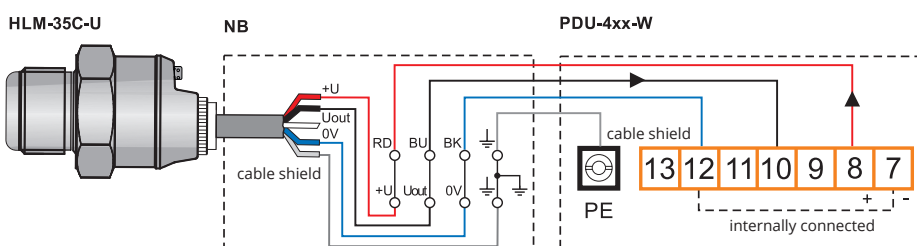

In the case using a connection box with integrated overvoltage protection, the sensor needs to be connected to the bottom series of terminals. This series of contacts is marked by label SENSOR.

Legend:

- BR - brown (cable without capillary)
- RD - red (cable with capillary)
- BU - blue
- BK - black
- cable shield

CONNECTING THE HLM-35 LEVEL METER WITH CURRENT OUTPUT TO THE PCU-100

Here is the wiring of the PCU-100-_-I unit with the HLM-35N-_-I level meter.

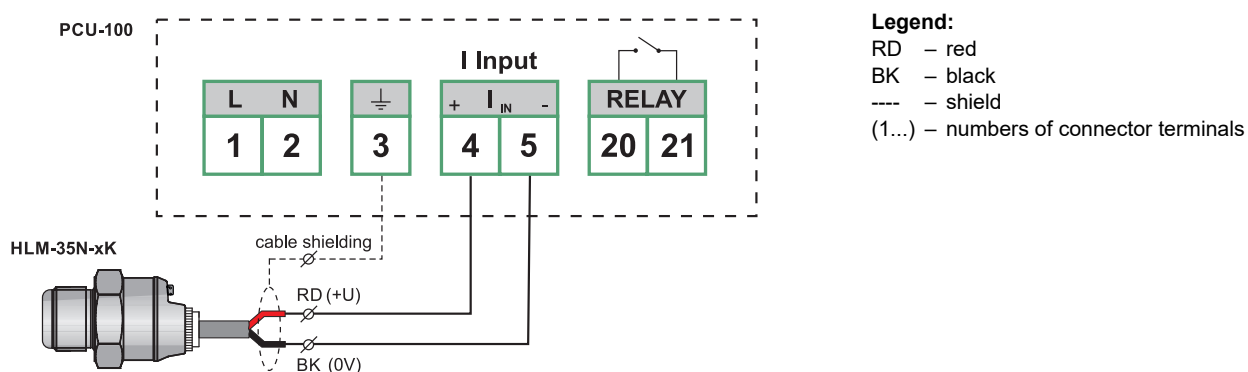

USER-ADJUSTABLE MEASURING RANGES

For the variants of sensors with the possibility of user settings, it is possible to choose from the ranges shown in the following table.

USER-ADJUSTABLE MEASURING RANGES FOR THE M VARIANT					
stainless steel membrane of the sensor			ceramic membrane of the sensor		
measuring range [m]	code marking	Adjustable range of the water column [m]	measuring range [m]	code marking	Adjustable range of the water column [m]
0 ... 1,0	0010	1,0	0 ... 5,0	0050	5,0
0 ... 3,5	0035	1,0 - 3,5	0 ... 10	0100	5,0 - 10
0 ... 7,0	0070	3,5 - 7,0	0 ... 20	0200	10 - 20
0 ... 10	0100	7,0 - 10	0 ... 50	0500	20 - 50
0 ... 25	0250	10 - 25	0 ... 100	1000	50 - 100
0 ... 40	0400	25 - 40	-	-	-
0 ... 60	0600	40 - 60	-	-	-
0 ... 100	1000	60 - 100	-	-	-

The above table defines the setting variances for each range for both stainless steel and ceramic transducers. The level meters with a broad range are not recommended to be used to measure low levels. Such usage of the sensor brings a more significant measurement error into the measuring system.

ORDER CODE

PRODUCT

HLM-35

PERFORMANCE

N non-explosive areas

TYPE OF MEMBRANE

- CV** ceramic membrane of the sensor, pressure compensation via semi-permeable valve
- CK** ceramic membrane of the sensor, pressure compensation by capillary
- SV** stainless steel membrane of the sensor, pressure compensation via a semi-permeable valve
- SK** stainless steel membrane of the sensor, pressure compensation by capillary

PROCESS CONNECTION

- G** pipe thread G 3/4
- M27** metric thread M 27x2

TYPE OF OUTPUT

- I** current (4 ... 20 mA)
- U** voltage (0 ... 10 V), not available for membrane type SV, SK

CONNECTION METHOD

- A** stainless steel cable gland for CV and SV
- B** plastic threaded cable gland, for CV, CK, SV and SK
- C** connector (socket not included with sensor, recommended type - see accessories.) for CV and SV
- V** plastic cable gland with spiral relief for CV, CK,SV and SK
- H** plastic cable gland for protective hose for CV and SV

SET-UP ELEMENTS

- M** Settings using the magnetic pen
- L** Without set-up elements; this cannot be used with the SV- and SK-type diaphragm

MEASURING RANGE

0010 ... 1000 1 ... 100 m (see the table above)

CABLE

- K** cable length in m

HLM-35 N - CV - M27 - I - A - M - 0035 K 2 M AVAILABLE PRODUCT ALTERNATIVES

1) factory setting to the required range, according to the ordering code (measuring range).

ACCESSORIES

optional – for a surcharge (see catalogue sheet of accessories)

- cable (over the standard length 2m)
- connector socket (type ELWIKa or ELKA)
- non-hermetic connection box NB
- standard steel or stainless steel welding flange
- protective hose (for type of cable outlet H)
- stainless steel fixing nut
- various types of seals (PTFE, Al, etc.)

SAFETY, PROTECTIONS AND COMPATIBILITY

Level meter HLM-35 is equipped with protection against voltage polarity reversal, protection against current overload and protection against short term overvoltage.

Protection against dangerous contact is provided by low safety voltage according to 33 2000-4-41.

Electromagnetic compatibility is provided by conformity with standards EN 55011/B, EN 61326-1, EN 61000-4-2, -4-3, -4-4, -4-5 and -4-6.

PACKAGING, SHIPPING AND STORAGE

The HLM-35 device is supplied packaged in a cardboard box that protects it against mechanical damage.

When handling and during transport, it is necessary to prevent impacts and falls.

The HLM-35 electrical device must be stored in dry enclosed areas with humidity up to 85%, free of aggressive vapours at temperatures between -25°C and 70°C, and must be protected against the effects of weather.

Version 05/2022

The manufacturer reserves the right to change the specifications and appearance of the product without prior notice.

HLM-35-dat-9.3



QMS
ISO 9001

Dinel, s.r.o.
U Tescomy 249
760 01 Zlín, Czech Republic

Phone: +420 577 002 003

sale@dinel.cz
www.dinel.cz