

CLM-36

Dinel®

CAPACITIVE LEVEL METER

For continuous level measurement of liquids, bulk solids and powders in tanks, hoppers, silos etc.



- For continuous level measurement of liquid and bulk-solid materials
- Direct mounting into containers, silos, vessels, basins, reservoirs, etc
- Variants with rope electrode or with coated electrode for aggressive and electrically conductive medium
- Possibility of linear measurements even in nonconductive and differently shaped vessels
- Variants for usage in explosive areas, high temperature performance
- Current (4 ... 20 mA) or voltage (0 ... 10 V) output

TECHNICAL SPECIFICATION (variants N, NT)

Supply voltage	CLM-36N(T)-___-I CLM-36N(T)-___-U	9 ... 36 V DC 16 ... 36 V DC
Current output Voltage output		4 ... 20 mA 0 ... 10 V *
Power consumption (off-load) CLM-36N(T)-___-U		cca. 8 mA
Sensitivity ranges		20; 30; 50; 100; 150; 300; 500; 1000 pF
Initial capacity regulation ratio		min. 1:2
Nonlinearity		max. 1%
Temperature error		max. 0,05 % / K
Voltage error for current and voltage output		max. 0,3 µA/V a 0,1 mV/V
Internal resistance / Electric strength (Electrode – Housing)		1 MΩ / 250 V AC
Coupling capacity / Electric strength (Housing – Supply leads)		51 nF / 250 V AC
Protection class	standard	IP67 (Housing), IP65 (Connector)
	Optional (Connector GAN-DADE 7A / DAEE 7A)	IP67
Maximal load (serial) resistance for current output (U = 24 V)		R _{max} = 750 Ω
Minimal load resistance for voltage output		R _{min} > 1 kΩ
Maximum tensile strength of the rope electrode		1400 kg
Recommended cable		PVC 2x 0,75 mm ² (3x 0,5 mm ²)
Weight (exclude electrode)	Version N, Xi	approx. 0,5kg
	Version NT, XiT	approx. 1 kg

*) Upon request, a different type of output terminal can be produced (e.g. 0 - 5 V)

BASIC FEATURES AND VARIANTS

Capacitive level meters CLM® are designed for continuous level measurement of liquids, powders and bulk-solid materials in vessels, tanks, sumps, containers, silos, etc. CLM consists of the stainless steel housing with electronic module and the measuring electrode. The electronic part converts the capacity into the current signal (4 ... 20 mA) or voltage signal (0 ... 10 V). Sensitivity (SPAN) and initial capacity compensation (ZERO) can be fluently set.

Level meters are produced in the following performances: **N** – for non-explosive areas, **NT** – high temperature for non-explosive areas, **Xi** – Explosion proof – intrinsically safe for hazardous (explosive) areas and **XIT** - high-temperature conf. for explosive environments. CLM are offered in variants with various types of process connection (thread, Tri-clamp).

Variants

code	type of electrode	length of electrode
CLM-36_-10	With uncoated rod electrode	0,2 ... 5 m
CLM-36_-11	With fully (PFA) coated rod electrode	0,2 ... 3 m
CLM-36_-12	With fully (FEP) coated rod electrode	0,2 ... 3 m
CLM-36_-20	With uncoated rod electrode and reference tube	0,2 ... 3 m
CLM-36_-22	With fully FEP coated rod electrode and reference tube	0,2 ... 3 m
CLM-36_-30	With uncoated stainless steel rope electrode and uncoated weight	1 ... 20 m
CLM-36_-31	With uncoated stainless steel rope electrode and coated dynamic anchorage	1 ... 20 m
CLM-36_-32	With fully coated rope electrode and coated weight (rope insulation FEP, weight insulation PTFE)	1 ... 15 m

DIMENSIONS

CLM - 36_-10, 11, 12

CLM - 36_-20, 22

CLM - 36_-30

CLM - 36_-31

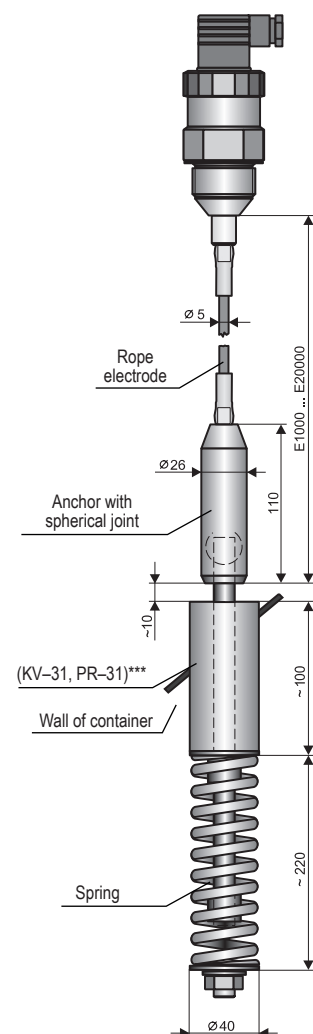
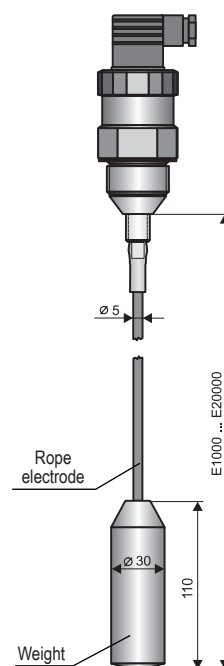
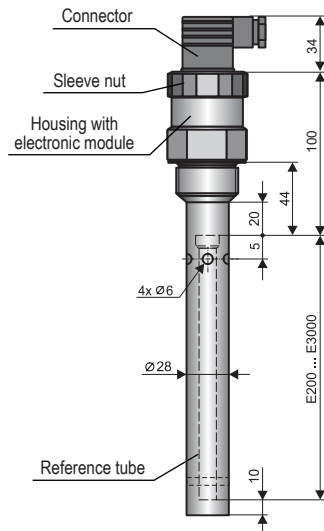
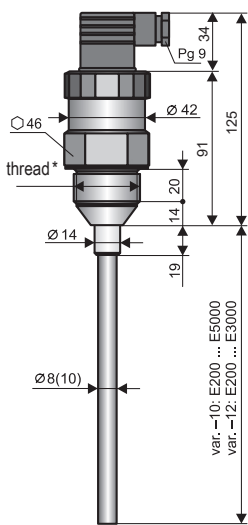

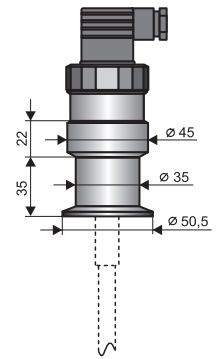
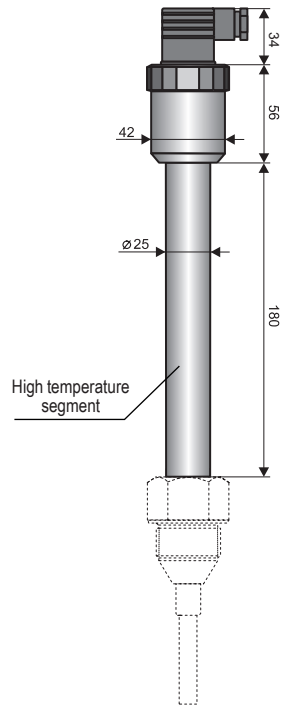
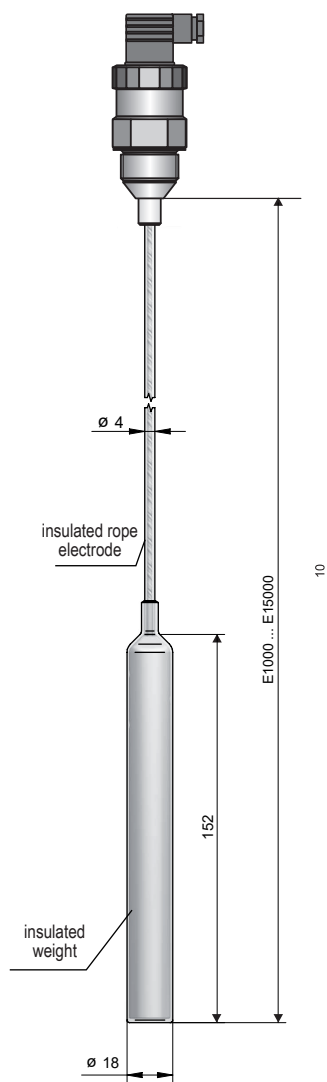

* type threads: M36x2; G 1"

** for materials with a low permittivity ($\epsilon_r < 10$) the minimum electrode length is E500.

*** Anchor welding cylinder KV-31 or Dust-tight bushing PR-31 (see accessories)

**** type of threads: Tri-Clamp CI50 ($\varnothing 50,5$ mm)

(variants Xi, XiT)

Supply voltage	9 ... 30 V DC
Max. internal values	U _i = 30 V DC; I _i = 132 mA; P _i = 0,99 W; C _i = 370 nF; L _i = 0,9 mH
Internal resistance / Electric strength (Electrode – Housing)	1 MΩ / 250 V AC
Coupling capacity / Electric strength (Housing – Supply leads)	26 nF / 500 V AC
Allowed temperature range in zone 0 (EN 50284)	-20 ... +60°C
Allowed pressure range in zone 0 (EN 50284)	0,08 ... 0,11 MPa

USED MATERIALS

Sensor part	Variants	Standard material*
Housing	All types, except Tri-Clamp Tri-Clamp	St. Steel W. Nr. 1.4301 (AISI 304) St. Steel W.Nr. 1.4404 (AISI 316 L)
Insulating bushing	All types	PTFE
Electrode	CLM – 36_–10, 11, 12, 20, 22 CLM – 36_–30, 31, 32	St. Steel W.Nr. 1.4404 (AISI 316 L) St. Steel W.Nr. 1.4401 (AISI 316)
Electrode coating	CLM – 36_–12, 22, 32 CLM – 36_–11	FEP PFA
Weight insulation	CLM – 36_–32	FEP
Weight / Anchor mechanism	CLM – 36_–30, 31, 32	St. Steel W. Nr. 1.4301 (AISI 304)
Reference tube	CLM – 36_–20, 22	St. Steel W. Nr. 1.4301 (AISI 304)

* It is always necessary to verify the chemical compatibility of the material with the measured medium. After agreement, another type of material can be selected.

Type	Size	Marking
Metric thread	M36 x 2	M
Pipe thread	G 1"	G
Jointless connection (Tri-Clamp)	ø 50,5 mm	CI50

WORKING AREAS AND AREA CLASSIFICATION (EN 60079-0, EN 60079-10-1(2))

CLM – 36N	Basic performance for non-explosive atmospheres.
CLM – 36NT	High-temperature basic performance for non-explosive atmospheres.
CLM – 36Xi (10, 20, 30, 31)	Intrinsically safe design for use in hazardous areas (explosive gaseous atmospheres or explosive atmospheres with dust) Ⓜ II 1 G Ex ia IIB T5...T2 Ga; Ⓜ II 1 D Ex ia IIIC T ₂₀₀ 115°C...T200 240°C Da with intrinsically safe power supply unit, entire sensor zone 0 and 20.
CLM – 36Xi (11, 12, 22, 32)	Intrinsically safe design for use in hazardous areas (explosive gas atmospheres) Ⓜ II 1 G Ex ia IIB T5...T2 Ga with intrinsically safe power supply unit, entire sensor zone 0.
CLM – 36XiT (10, 20, 30, 31)	Jiskově bezpečné vysokoteplotní provedení pro použití v nebezpečných prostorech (výbušné plynné atmosféry nebo výbušné atmosféry s prachem) Ⓜ II 1/2 G Ex ia IIB T5...T2 Ga/Gb; Ⓜ II 1/2 D Ex ia IIIC T ₂₀₀ 105°C...T ₂₀₀ 280°C/ T90°C...T 265°C Da/Db with intrinsically safe power supply unit, electrode part zone 0 and 20, head zone 1 and 21.
CLM – 36XiT (11, 12, 22, 32)	Intrinsically safe high-temperature design for use in hazardous areas (explosive gas atmospheres) Ⓜ II 1/2 G Ex ia IIB T5...T2 Ga/Gb with intrinsically safe power supply unit, electrode part zone 0, head zone 1.

TEMPERATURE DURABILITY

Variants / Performance	temperature t_m	temperature t_p	temperature t_a
CLM-36N-10, 20	-40 °C ... +300 °C	-40 °C ... +85 °C	-40 °C ... +85 °C
CLM-36N-11, 12, 22	-40 °C ... +200 °C	-40 °C ... +85 °C	-40 °C ... +85 °C
CLM-36N-30	-40 °C ... +200 °C	-40 °C ... +85 °C	-40 °C ... +85 °C
CLM-36N-31 (incl. PR-31)	-40 °C ... +130 °C	-40 °C ... +85 °C	-40 °C ... +85 °C
CLM-36N-31 (incl. KV-31)	-40 °C ... +250 °C	-40 °C ... +85 °C	-40 °C ... +85 °C
CLM-36N-32	-40 °C ... +130 °C	-40 °C ... +85 °C	-40 °C ... +85 °C
CLM-36Xi-10, 20	-40 °C ... +200 °C	-40 °C ... +75 °C	-40 °C ... +75 °C
CLM-36Xi-11, 12, 22	-40 °C ... +120 °C	-40 °C ... +75 °C	-40 °C ... +75 °C
CLM-36Xi-30	-40 °C ... +105 °C	-40 °C ... +75 °C	-40 °C ... +75 °C
CLM-36Xi-31 (incl. PR-31)	-40 °C ... +105 °C	-40 °C ... +75 °C	-40 °C ... +75 °C
CLM-36Xi-31 (incl. KV-31)	-40 °C ... +105 °C	-40 °C ... +75 °C	-40 °C ... +75 °C
CLM-36Xi-32	-40 °C ... +105 °C	-40 °C ... +75 °C	-40 °C ... +75 °C
CLM-36NT-10, 20	-40 °C ... +300 °C	-40 °C ... +200 °C	-40 °C ... +85 °C
CLM-36NT-11, 12, 22	-40 °C ... +200 °C	-40 °C ... +200 °C	-40 °C ... +85 °C
CLM-36NT-30	-40 °C ... +250 °C	-40 °C ... +130 °C	-40 °C ... +85 °C
CLM-36NT-31 (incl. PR-31)	-40 °C ... +130 °C	-40 °C ... +130 °C	-40 °C ... +85 °C
CLM-36NT-31 (incl. KV-31)	-40 °C ... +250 °C	-40 °C ... +130 °C	-40 °C ... +85 °C
CLM-36NT-32	-40 °C ... +200 °C	-40 °C ... +200 °C	-40 °C ... +85 °C
CLM-36XiT-10, 20	-40 °C ... +200 °C	-40 °C ... +200 °C	-40 °C ... +75 °C
CLM-36XiT-11, 12, 22	-40 °C ... +120 °C	-40 °C ... +200 °C	-40 °C ... +75 °C
CLM-36XiT-30	-40 °C ... +250 °C	-40 °C ... +130 °C	-40 °C ... +75 °C
CLM-36XiT-31 (incl. PR-31)	-40 °C ... +130 °C	-40 °C ... +130 °C	-40 °C ... +75 °C
CLM-36XiT-31 (incl. KV-31)	-40 °C ... +250 °C	-40 °C ... +130 °C	-40 °C ... +75 °C
CLM-36XiT-32	-40 °C ... +200 °C	-40 °C ... +200 °C	-40 °C ... +75 °C

Note: For correct function of the level meter must not be exceeded any of the temperature range (t_p , t_m or t_a)

1) The temperatures are clearly explained on Fig.

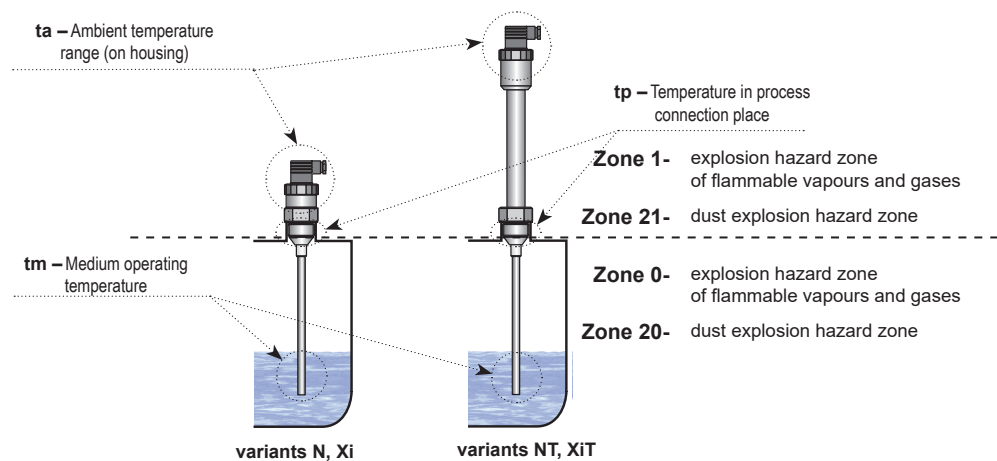

PRESSURE DURABILITY

Variants / Performance	Maximal operation pressure for temperature tp				
	Up to 30 °C	Up to 85 °C	Up to 130 °C	Up to 160 °C	Up to 200 °C
CLM-36N-10, 20	7 MPa	5 MPa	–	–	–
CLM-36N-11, 12, 22	4 MPa	2 MPa	–	–	–
CLM-36N-30	7 MPa	5 MPa	–	–	–
CLM-36N-31	–	–	–	–	–
CLM-36N-32	1 MPa	0,5 MPa	–	–	–
CLM-36Xi-10, 20	7 MPa	5 MPa	–	–	–
CLM-36Xi-11, 12, 22	4 MPa	2 MPa	–	–	–
CLM-36Xi-30	7 MPa	5 MPa	–	–	–
CLM-36Xi-31	–	–	–	–	–
CLM-36Xi-32	1 MPa	0,5 MPa	–	–	–
CLM-36NT-10, 20	7 MPa	5 MPa	3 MPa	2 MPa	1 MPa
CLM-36NT-11, 12, 22	6 MPa	4 MPa	2 MPa	1,5 MPa	0,3 MPa
CLM-36NT-30	7 MPa	5 MPa	3 MPa	–	–
CLM-36NT-31	–	–	–	–	–
CLM-36NT-32	1 MPa	0,5 MPa	0,1 MPa	–	–
CLM-36XiT-10, 20	7 MPa	5 MPa	3 MPa	2 MPa	1 MPa
CLM-36XiT-11, 12, 22	6 MPa	4 MPa	2 MPa	1,5 MPa	0,3 MPa
CLM-36XiT-30	7 MPa	5 MPa	3 MPa	–	–
CLM-36XiT-31	–	–	–	–	–
CLM-36XiT-32	1 MPa	0,5 MPa	0,1 MPa	–	–

INFLUENCE OF THE TANK SHAPE ON A LINEARITY OF MEASUREMENT

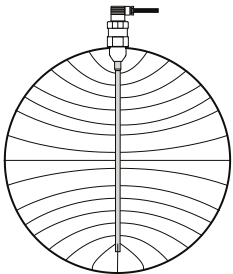

In a curved tanks (most frequently horizontal cylinder) capacity change during measuring of electrically non-conductive material is non-linear.

**FOR TYPE: CLM-36_-10, 11, 12
CLM-36_-30, 31, 32**

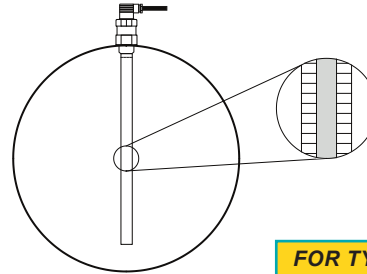

Linearity is done by reference tube (CLM - 36_-20, 22).

FOR TYPE: CLM-36_-20, 22

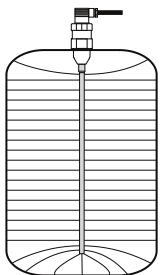

In the tank with straight wall (for example vertical cylinder) and with the sensor placed parallelly with the wall capacity change is linear.

FOR TYPE: all types

RANGE OF APPLICATION

Capacitive level meters are suitable for continuous level measurement of liquid and bulk-solid materials. CLMs are resistant to any changes in the atmosphere above the surface (vacuum, pressure, vapours, dust).

ELECTRICAL CONNECTION

The level meter is designed to be connected to supply unit or to controller through a cable with the outer diameter of $6 \div 8$ mm (recommended cross-section of cores $0.5 \div 0.75$ mm²) by means of connector which is standard part of CLM level meter. The diagram and the inside view of the connector are shown in the figures. Disassemblable connector IP67 with a 5m long PVC cable can be supplied as an above-standard accessory.

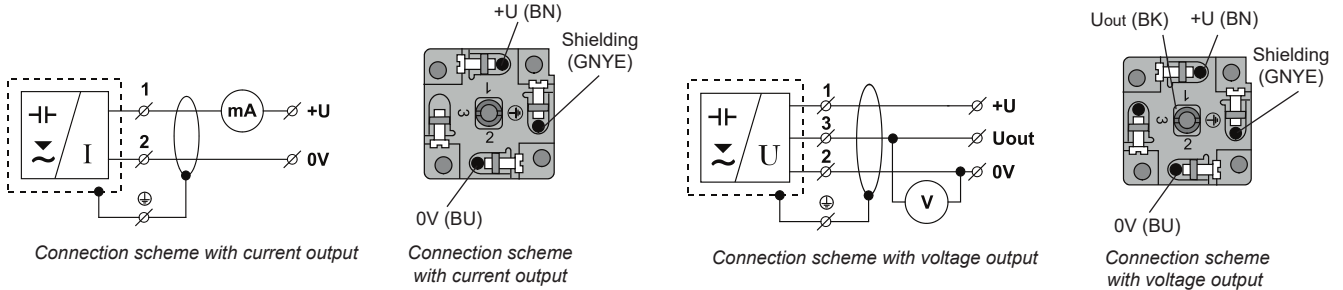

SETTINGS

The adjustment of level meter is by DIP switches and two trimmers 4 mA and 20 mA (to set min. and max. level). These adjustment elements are placed under outlet nut of level meter. For detailed information please read at the instructions.

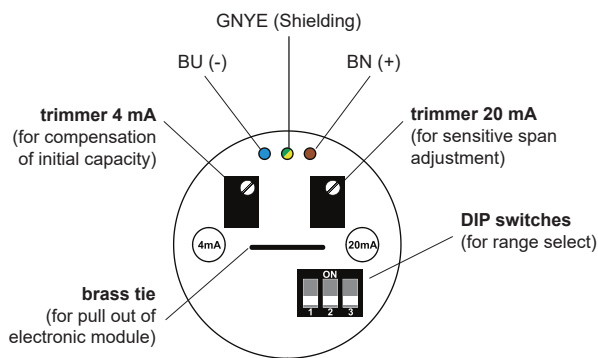

The top view on the internal electronic module with current output (variant –I)

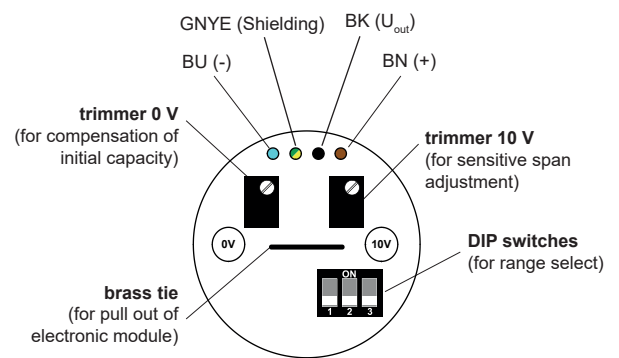

The top view on the internal electronic module with voltage output (variant –U)

Legend:



GNYE – green-yellow BK – black
 BN – brown BU – blue

ORDER CODE

PRODUCT

CLM-36

PERFORMANCE

N	non-explosive areas
NT	high temperature performance
Xi	 for explosive environments
XiT	 high-temperature conf. for explosive environments

TYPE AND PERFORMANCE OF ELECTRODE

10	uncoated St. steel rod electrode, length 0,2 / 0,5 ... 5 m
11	fully coated St. steel rod electrode (PFA), length 0,2 ... 3 m
12	fully coated St. steel rod electrode (FEP), length 0,2 ... 3 m
20	uncoated St. steel rod electrode with reference tube, length 0,2 ... 3 m
22	coated St. steel rod electrode with reference tube (FEP), length 0,2 ... 3 m
30	uncoated St. steel rope electrode, length 1 ... 20 m
31	uncoated St. steel rope electrode with anchor, length 1 ... 20 m
32	suspension electrode with insulated cable (FEP) and insulated ballast (PTFE), length 1 ... 15 m

PROCESS CONNECTION

M	thread M36x2
G1	thread G1"
CI50	Tri-clamp (ø 50,5 mm)

OUTPUT TYPE

I	current (4 ... 20 mA)
U	voltage (0 ... 10 V)

LENGTH OF ELECTRODE

E	electrode length in mm
----------	------------------------

CLM-36 N - 10 - G1 - I - E1000

EXAMPLE OF CODING

CORRECT SPECIFICATION EXAMPLES

CLM-36N-10-G1-I E1000

(**N**) normal (for non-explosive areas); (**10**) uncoated St. steel rod electrode; (**G1**) process connection thread G1"; (**I**) current (4 ... 20 mA); (**E1000**) length electrode 1000 mm

CLM-36XiT-30-G1-I E9750

(**XiT**) high-temperature conf. for explosive environments; (**30**) uncoated St. steel rope electrode; (**G1**) process connection thread G1"; (**I**) current (4 ... 20 mA); (**E9750**) length electrode 9750 mm.

ACCESSORIES

standard (included in the level meter price)

- 1x of seal, other seals are on request (PTFE, Al, etc.) *
- 1x connector socket
- 1x screwdriver for adjustment (each 5 pcs)

optional – for a surcharge (see catalogue sheet of accessories)

- Connector with protection class IP67 (GAN-DADE 7A) with 5 m cable (current output)
- Connector with protection class IP67 (GAN-DAAE 7A) with 5 m cable (voltage output)
- Steel welding flange ON-36x2
- St. steel welding flange NN-36x2
- St. steel fixing nut UM-36x2
- Anchor welding cylinder KV-31 (only CLM-36-31)
- Dust-tight bushing PR-31(only CLM-36-31)

* Pressure resistance - see the table in the accessories datasheet in the "seals and gaskets".

SAFETY, PROTECTIONS, COMPATIBILITY AND EXPLOSION PROOF

The level sensor is equipped with protection against fault voltage at the electrode, over-polarity, short-term over-voltage and over-current at the output.

Protection against dangerous contact is ensured by small safe voltage according to 33 2000-4- 41. EMC is ensured by compliance with EN 55022 / B, EN 61326-1, EN 61000-4-2 to -6.

The explosion-proof design of the CLM-36Xi(XiT) is ensured by compliance with the standards of EN IEC 60079- 0:2018, EN 60079-11:2012.

The explosion-proofness of CLM-36Xi(XiT) is verified by FTZÚ - AO 210 Ostrava - Radvanice: FTZÚ 02 ATEX 0235X.

A declaration of conformity has been issued for this equipment in accordance with Act 90/2016 Coll. and subsequent amendments. The delivered electrical equipment meets the requirements of the applicable government regulations on safety and electromagnetic compatibility.

Special conditions for safe use of variants CLM-36Xi

The connected intrinsically safe device must be galvanically isolated, or in the case of using devices without galvanic isolation (Zener barriers), potential equalization must be carried out between the sensor and the grounding point of the barriers.

The CLM-36Xi version can be placed in zone 0 or zone 20. For the CLM-36XiT version, only the electrode part can be placed in zone 0 and zone 20 and the head with electronics in zone 1 or zone 21.

The temperature classes and maximum surface temperatures depend on the temperature of the medium.

Version Xi:

Temperature classes for EPL Ga:

T2 ... apply for a maximum medium temperature of $T_m = 275\text{ °C}$.

T3 ... applies for a maximum medium temperature of $T_m = 180\text{ °C}$.

T4 ... valid for maximum medium temperature $T_m = 115\text{ °C}$.

T5 ... is valid for a maximum medium temperature $T_m = 80\text{ °C}$.

Maximum surface temperature for EPL Da:

The temperature range of the medium is -40 °C to 200 °C .

The maximum surface temperature must be calculated as $T_{200} = T_m + 40\text{ °C}$.

XiT version:

Temperature classes for EPL Ga/Gb:

T2 ... apply for a maximum medium temperature of $T_m = 275\text{ °C}$.

T3 ... applies for a maximum medium temperature of $T_m = 180\text{ °C}$.

T4 ... valid for maximum medium temperature $T_m = 115\text{ °C}$.

T5 ... is valid for a maximum medium temperature $T_m = 80\text{ °C}$.

Temperature classes for EPL Da/Db:

The temperature range of the medium is -40 °C to 250 °C .

The maximum surface temperature for the EPL Da part of the product must be calculated as $T_{200} = T_m + 40\text{ °C}$.

The maximum surface temperature for the EPL Db part of the product must be calculated as $T_{200} = T_m + 15\text{ °C}$.

For explosive atmospheres with dust, the equipment must be installed in such a way as to prevent the risk of creeping discharges on the label, cable gland or connector of the equipment.

The manufacturer reserves the right to change the specifications and appearance of the product without prior notice.

Dinel, s. r. o.
U Tescomy 249, 760 01 Zlín
tel.: +420 577 002 000
e-mail: sale@dinel.cz

www.dinel.cz

version:
12/2023

