



## CAPACITIVE LEVEL SENSORS CLS-23

---





# CONTENT

---

1. Basic description .....	4
2. Variants of sensors .....	5
3. Dimensional drawing.....	5
4. Installation and putting into operation .....	6
5. Mechanical mounting .....	6
6. Electrical connection .....	9
7. Settings .....	11
8. Function and status indication (only with LED state indicator variant).....	12
9. Order code .....	13
10. Correct specification examples .....	13
11. Accessories.....	14
12. Safety, protection, compatibility and explosion proof .....	14
13. Functional safety .....	15
14. Use, manipulation and maintenance.....	15
15. Putting out of operation or disposal .....	16
16. General conditions and warranty .....	16
17. Marking of labels .....	17
18. Technical specifications.....	18
19. Packing, shipping and storage .....	21

## USED SYMBOLS

---

To ensure maximum safety of control processes, we have defined the following safety instructions and information. Each instruction is labelled with the appropriate pictogram.



### **Alert, warning, danger**

This symbol informs you about particularly important instructions for installation and operation of equipment or dangerous situations that may occur during the installation and operation. Not observing these instructions may cause disturbance, damage or destruction of equipment or may cause injury.



### **Information**

This symbol indicates particularly important characteristics of the device.



### **Note**

This symbol indicates helpful additional information.

## SAFETY

---



**All operations described in this instruction manual have to be carried out by trained personnel or by an accredited person only. Warranty and post warranty service must be exclusively carried out by the manufacturer.**

**Improper use, installation or set-up of the sensor can lead to crashes in the application.**

**The manufacturer is not responsible for improper use, loss of work caused by either direct or indirect damage, and for expenses incurred at the time of installation or during the period of use of the level sensors.**

## 1. BASIC DESCRIPTION

---

**Capacitive level sensors (switches) CLS–23** are designed for limit level detection of electrically conductive and non-conductive fluids in vessels, reservoirs, sumps, pipes, tanks, etc. The sensitivity of the sensor can be easily set by placing magnetic pen on sensitive spot.

The process coupling at the housing can be with metric thread (M18x1.5 ; M20x1.5), pipe thread (G3/8" ; G1/2") or sealing thread (NPT 1/2–14). Output performances – transistor output with open collector (PNP), two wire electronic switch (S) and NAMUR output for intrinsically safe connection.

There are next performances available: **N** – Normal for non-explosive areas, **E** – Extended temperature range for non-explosives areas, **Xi** – Explosion proof (intrinsically safe for explosive areas), **NT** – High temperature variant for non-explosives areas and **XiT** – High temperature variant for explosive areas.

CLS-23 capacitive level sensors meet the safety integrity level requirements according to standard EN 61508 at level SIL 1.

\* Variant „E“ without LED state indicator

## 2. VARIANTS OF SENSORS

- **CLS-23\_-10 Uncoated short bar electrode**, for sensing the level of electrically non-conductive liquids (oil, crude oil products). Assembly into a side wall of vessel or into a pipe. Electrode length 30 mm.
- **CLS-23\_-11 Fully coated short bar electrode**, for sensing the level of non-aggressive electrically conductive liquids (water, water solutions). Electrode insulation from PP material, assembly into a side wall of vessel or into a pipe. Electrode length 30 mm.
- **CLS-23\_-12 Fully coated short bar electrode**, for sensing the level of electrically conductive liquids (various chemicals, moderately aggressive water solutions). Higher temperature resistance compared to variant "11". Electrode insulation from FEP material. Assembly into a side wall of vessel or into a pipe. Electrode length 30 mm.
- **CLS-23\_-20 Partially coated rod electrode**, for sensing the level of electrically conductive and non-conductive liquids, partially resistant against fume condensation in the sensed area. Electrode insulation from FEP material. Installation from above, on shorter electrodes (max. 200 mm) also from the side. Electrode length from 50 mm to 1 m.
- **CLS-23\_-21 Fully coated rod electrode**, universal use, for sensing the level of electrically conductive liquids. Resistant against fume condensation and partially resistant against spraying media. Electrode insulation from FEP material. Installation from above, on shorter electrodes (max. 200 mm) also from the side. Electrode length from 50 mm to 1 m.
- **CLS-23\_-30 Dismountable uncoated rod electrode** for sensing the level of conductive or non-conductive liquids. Installation from above, on shorter electrodes (max. 200 mm) also from the side. Electrode length from 50 mm to 1 m.

## 3. DIMENSIONAL DRAWING

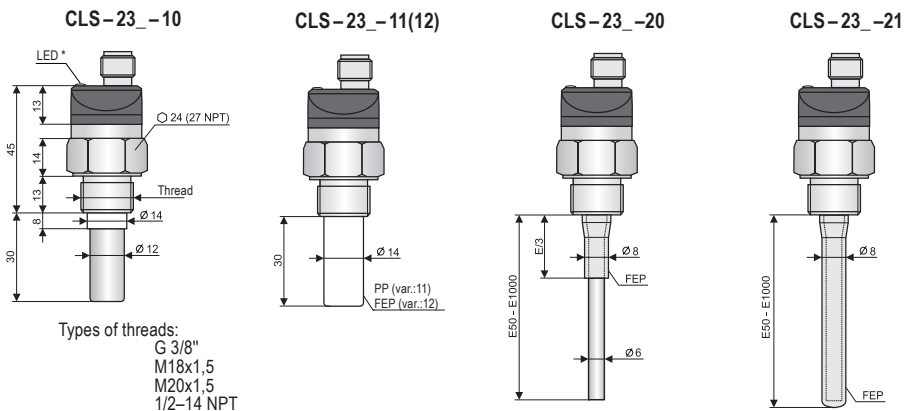

CLS-23\_-30

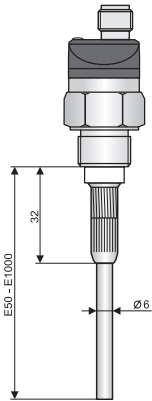

High temperature variants  
(CLS-23\_T-10; 12; 20; 21; 30)

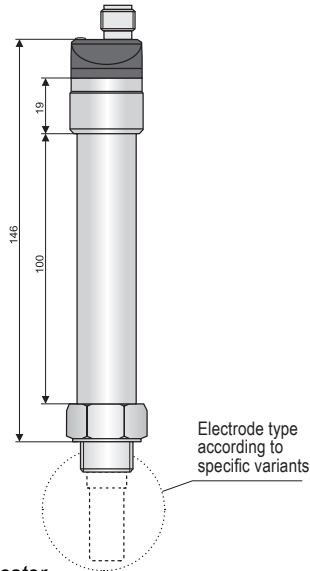

Variant „C“ with connector  
(outside CLS-23E\*)

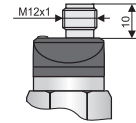

Variant „A“  
with cable outlet

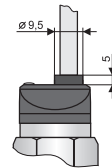

Magnetic pen MP-8

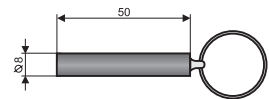

\* Variant „E“ without LED state indicator

## 4. INSTALLATION AND PUTTING INTO OPERATION

Please follow next 3 steps:

- **MECHANICAL MOUNTING - SEE CHAPTER 5**
- **ELECTRICAL CONNECTION - SEE CHAPTER 6**
- **SETTINGS - SEE CHAPTER 7**

## 5. MECHANICAL MOUNTING

- DLS® level sensors can be fixed in a vertical, horizontal or slanted position into the wall of a vessel, storage tank or on a fixation console in a sump by screwing into the welding flange, using a fixing nut.
- Basic application recommendations are mentioned below.



*During assembly into the metal tank or the storage tank, it is not necessary to separately ground the base of the level sensor. In case of installation in concrete sumps or silos, it is appropriate to install the level sensor onto a metallic auxiliary construction (console, lid, etc.), and then connect to a metallic, constantly submerged object, or with steel with steel reinforcements in concrete (armouring).*

*In the case of the reading of an aggressive medium, we recommend that the producer be consulted*



**If the sensors are fitted with protective caps at the ends of the electrodes, remove the caps before commissioning.**

## VERTICAL MOUNTING

In case of **vertical mounting**, sensors can be mounted into open, closed and pressurized tanks. The stated distances relate to the electrode length (longer electrode).

$$c \geq 10 + \frac{E}{50} \quad d \geq 40 + \frac{E}{40} \quad k \geq 20 + \frac{E}{20}$$

E – Electrode length in mm

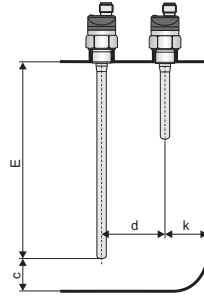

Fig. 1: Vertical mounting

## BYPASS MEASURING TUBE

Mounting in a **bypass measuring tube**. We recommend upholding the tube diameter.

$$b \geq 40 + \frac{E}{20}$$

E – Electrode length in mm

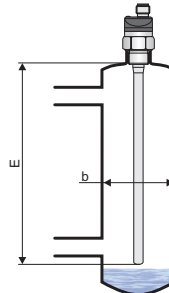

Fig. 2: Bypass measuring tube

## MOUNTING IN THE PIPE

In the case of **mounting in the pipe** it is necessary to provide the minimum distance of the inner walls from the electrode at **5 mm**. In some cases (sticky liquids, low permittivity liquids) it is better to mount the sensor into a **pipe bend**. Be careful of possible formation of **air pockets**.

## FOR TYPE: CLS-23\_-10, 11, 12, 20, 21

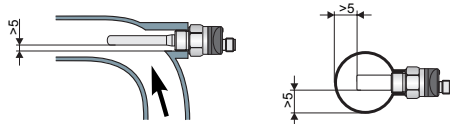

Fig. 3: Mounting in the pipe

**TWO STATE REGULATION BY HYSTERESIS SETTING**

**FOR TYPE: CLS-23\_-20, 30 (only for electrically non-conductive liquids)  
CLS-23\_-21 (for electrically conductive liquids)**

In case of **vertical mounting**, it is possible to use the sensor for simple **two-state regulation** of the level height between a min. and max. value. The position of the minimum and maximum level can be changed by setting the sensor. Upon a change in the measured medium, it is necessary to perform new limit settings.

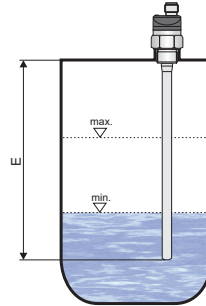

Fig. 4: Two state regulation by hysteresis setting

E – Electrode length in mm

**LONG FITTING TUBES IN SIDE WALL MOUNTING**

**FOR TYPE: All variants**

The installation of the sensor near the **inlet**, in the **narrow neck** or using an **unsuitable welding flange** may cause the incorrect sensor function.

*Suitable welding flanges can be found in the Dinel assortment, types ON, NN – see Accessories.*

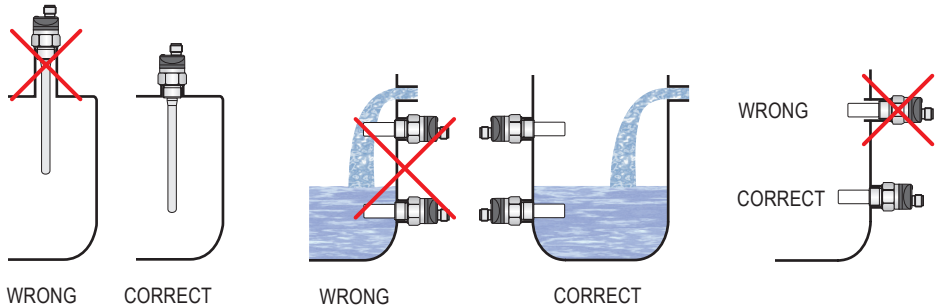

Fig. 5: Long fitting tubes in side wall mounting



## AUXILIARY ELECTRODE IN NON-CONDUCTIVE TANKS

**FOR TYPE: CLS-23\_-20, 21, 30 (for electrode length up to 300 mm)**

At sensors with the length of electrodes greater than 300 mm **it is necessary** to use an **auxiliary probe** (e.g. conductive probe) when installing from above on **non-conductive containers** for the maximum detection reliability. The auxiliary electrode is **connected electrically** with the housing of the sensor. The recommended length of the auxiliary electrode and the distance from the sensors are shown in the picture.

Suitable types of auxiliary electrodes are for example: Dinel CNP-18F-30 probes with an M18 thread or a PDE-18 plate electrode (see Accessories).

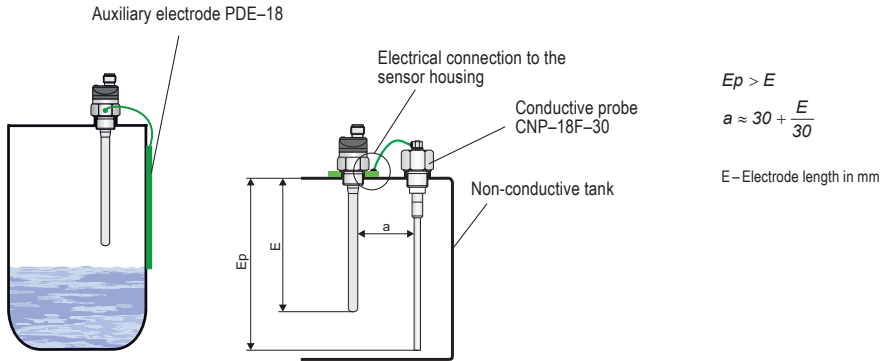

Fig. 6: Auxiliary electrode in non-conductive tanks

## 6. ELECTRICAL CONNECTION

For "A" variant with the fixed cable, the individual color cores of the connecting cable are connected to the respective terminals of the related equipment (supply unit).

For "C" variant with the connector, the cable can be supplied with the sensor (length 2 or 5 m), fitted with the pressed connector socket or dismountable connector socket without the cable (see accessories), the connector is not part of the sensor. In this case the cable is connected to the inside pins of the socket according to Fig. 10.

The sensor with related equipment is interconnected by a suitable three-core (P variation) or two-core (S and R variations) cable. The length of the cable for the Xi and XiT variations must be selected with respect to the maximum permitted parameters (usually inductance and capacity) of the outside intrinsically safe circuit of supply units (NSSU, NDSU, NLCU). If using a dismountable connector socket, the outside diameter of the cable is a maximum of 6 mm

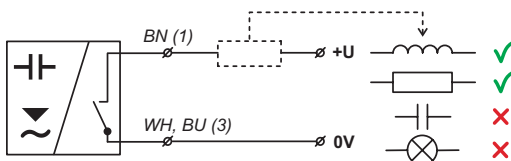

Fig. 7: "S" type sensors connection (2 - wire electronic switch)

Type **CLS-23\_-\_-S\_-**

The positive power terminal +U is connected via a load (e.g. a relay) to the brown wire, or connector pin no.1, the negative terminal to the white wire (configuration "N" and "NT") or to the blue wire (configuration "E") or to connector pin No.3.

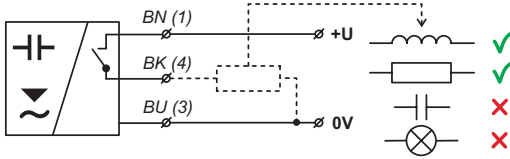

Fig. 8: "P" (PNP) type sensors connection

#### Type CLS-23 \_ \_ \_ -P \_ \_

Positive pole (+ U) of power supply is connected to brown wire or pin connector No. 1, negative pole is connected to blue wire or pin connector No. 3. Load (relay) is connected to black wire or pin connector No. 4.

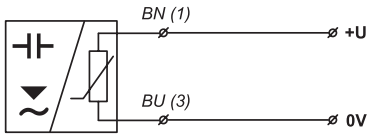

Fig. 9: "R" (NAMUR) type sensors connection

#### Type CLS-23 \_ \_ \_ -R \_ \_

Brown wire or pin connector No. 1 is connected to positive pole (+U) of Intrinsically safe supply unit. Blue wire or pin connector No. 3 is connected to negative pole of Intrinsically safe supply unit.

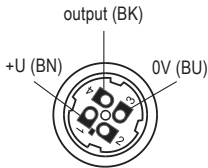

Fig. 10: Inside of the connector socket

#### Legend:

- (1...4) – terminals number for variants with connector  
 BN – brown  
 WH – white  
 BK – black  
 BU – blue



**Electrical connection can only be made when de-energized!**

The source of the power voltage must comprise of a stabilised safe low power source with galvanic separation. In the event that a switch-mode power supply is used, it is essential that its construction effectively suppresses common mode interference on the secondary side. In the event that the switch-mode power supply is equipped with a PE safety terminal, it must be unconditionally grounded! Spark-safe devices type CLS-23Xi (XiT) must be powered from a spark-safe power source meeting the above-mentioned requirements.



Due to the possible occurrence of an electrostatic charge on the non-conductive parts of the sensor, it is necessary to ground all sensors intended for use in environments with an explosion hazard CLS-23Xi (XiT). This can be performed by grounding el. conductive tanks or el. conductive tank lids, and in the case of el. non-conductive tanks using and grounding an auxiliary plate electrode PDE-27.

In the event that the level meter (sensor) is installed in an outdoor environment at a distance greater than 20 m from the outdoor switchboard, or from an enclosed building, it is necessary to protect the electrical cable leading to the level meter (sensor) with suitable overvoltage protection.

In the event of strong ambient electromagnetic interference, paralleling of conductors with power distribution, or for distribution to distances over 30 m, we recommend using a shielded cable and grounding the shielding on the side of the power source.

## 7. SETTINGS

The settings are done by touching a magnetic pen MP – 8 on the sensitive spot (M) located on the front-side of the sensor. By touching with the magnetic pen for a short time (max. 2 sec) on the sensitive spot (M), the sensor will open, holding down the magnetic pen for longer (min. 4 sec) the sensor will close. In this way, the sensitivity to the measured medium and the switching modes (O, C) are set.

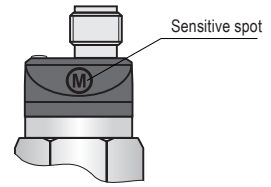

**mode O** (switches when submerged) On an empty or partially filled tank (level below the bottom edge of the sensor), touch the sensitive area (M) for 1 sec with the magnetic pen (the sensor will open). When the tank fills up above the top edge of the sensor, touch the sensitive area (M) for 5 sec. with the magnetic pen (the sensor will close).

**mode C** (unswitches when submerged) On an empty or partially filled tank (level below the bottom edge of the sensor), touch the sensitive area (M) for 5 sec with the magnetic pen (the sensor will close). When the tank fills up above the top edge of the sensor, touch the sensitive area (M) for 1 sec. with the magnetic pen (the sensor will open).

On installations from above, it is necessary during detection of **non-conductive** liquids using sensors **CLS-23\_-20; -30** and during detection of **conductive** and **non-conductive** liquids using sensor **CLS-23\_-21** to set the limits for closing and opening with the electrode submerged in the medium.

The closing and opening limits are shifted closer to the state with a submerged electrode.

*The CLS-23E range of sensors is made without a signal LED indicator. To check the correctness of settings, it is necessary to connect a connected device or a load and to use it to receive information about the opened / closed status of the sensor.*

### **FACTORY DEFAULT SETTINGS:**

Sensors **CLS-23\_-10; -20; -30** have factory default settings for detecting mineral oils, **CLS - 23\_- 11; -12; -21** for detecting drinking water. Switching is set to mode "O" (the sensor will close when submerged).

## 8. FUNCTION AND STATUS INDICATION (ONLY WITH LED STATE INDICATOR VARIANT)

In the following table are the types of inputs and the respective statuses (ON/ OFF) in the case of a maximum and minimum level sensing. The signalling of the status of the sensor is indicated by the orange LED located on the upper area of the sensor beside the connector (cable).

Indicator	Function
Orange LED	<b>Continuous light</b> – Sensor is closed (switched ON) <b>Dark</b> – Sensor is open (switched OFF) <b>Rapid flashing</b> (period 0.2 s) – error setting * <b>Slow flashing</b> (period 0.8 s) – short circuit at sensor output

\* Limit setting for closing (opening) on the same level or impossibility of differentiate between closing level and opening level (low permittivity of the medium).



Sensor with type output „S“ and „R“ for each flash of the LED switches its output on for approx. 3 ms. This period is sufficiently short to avoid unwanted switching of relay contacts. For binary inputs, we recommend to set the filter so as not to respond to pulses shorter than 3 ms.

Units Dinel NSSU, NDSU a NLCU with transistor switch („T“) detects and transmits these pulses to the output.

	Level state	Mode	Type of sensor	Output state	LED indicator *
Minimum level sensing		O	CLS-23 _ _ _ _ -P _ CLS-23 _ _ _ _ -S _	CLOSED	 (Shine)
			CLS-23Xi _ _ _ -R _ CLS-23XiT _ _ _ -R _	HIGHER CURRENT	
Minimum level sensing		O	CLS-23 _ _ _ _ -P _ CLS-23 _ _ _ _ -S _	OPEN	 (Dark)
			CLS-23Xi _ _ _ -R _ CLS-23XiT _ _ _ -R _	LOWER CURRENT	
Maximum level sensing		C	CLS-23 _ _ _ _ -P _ CLS-23 _ _ _ _ -S _	CLOSED	 (Shine)
			CLS-23Xi _ _ _ -R _ CLS-23XiT _ _ _ -R _	HIGHER CURRENT	
Maximum level sensing		C	CLS-23 _ _ _ _ -P _ CLS-23 _ _ _ _ -S _	OPEN	 (Dark)
			CLS-23Xi _ _ _ -R _ CLS-23XiT _ _ _ -R _	LOWER CURRENT	

\* Variant „E“ without LED state indicator



For security reasons, we recommend to set the mode O (normally open, sensor closes when immersed) for minimum level detection. Any failure of the sensor or wiring is equally apparent as the emergency level state. Analogously – for the maximum level detection is recommended to set the mode C (normally closed, sensor opens when immersed).

## 9. ORDER CODE

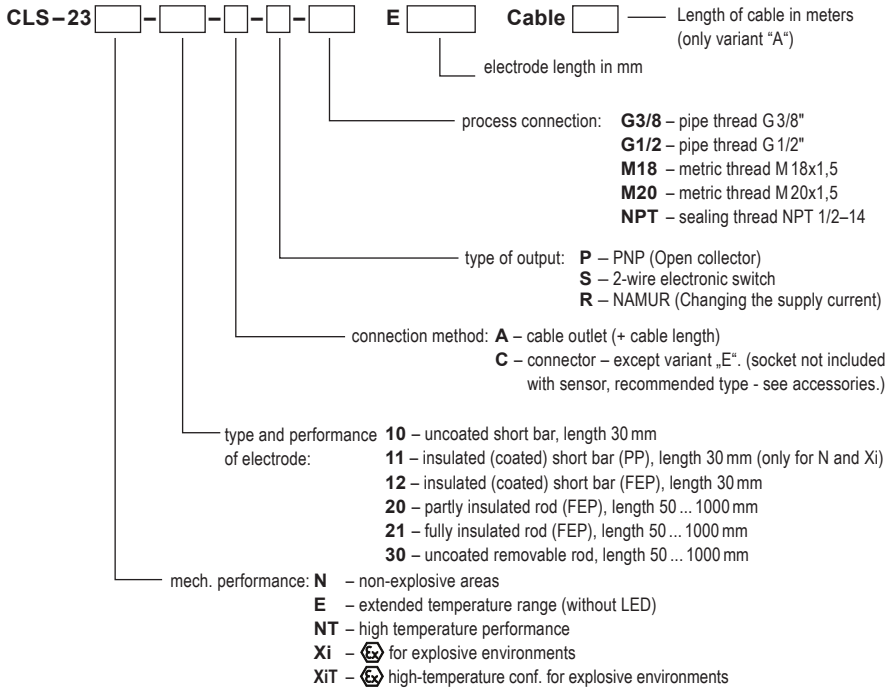

## 10. CORRECT SPECIFICATION EXAMPLES

CLS-23N-10-A-S-G3/8 cable 5 m

(**N**) performance for non-explosive areas; (**10**) uncoated short bar electrode 30 mm; (**A**) cable outlet with 5 m fixed cable; (**S**) 2-wire electronic switch; (**G3/8**) process connection with pipe thread G3/8".

CLS-23E-30-A-S-G1/2 E450 cable 10 m

(**E**) performance for extended temperature range performance for non-explosive areas; (**30**) uncoated removable rod electrode; (**A**) cable outlet with 10 m fixed cable; (**S**) 2-wire electronic switch; (**G1/2**) process connection with pipe thread G1/2"; (**E450**) electrode length 450 mm.

CLS-23NT-20-C-S-M18 E320

(**NT**) performance for high temperature performance; (**20**) partly insulated rod electrode (FEP); (**C**) electrically connection with connector; (**S**) 2-wire electronic switch; (**M18**) process connection with metric thread M18x1.5; (**E320**) electrode length 320 mm.

CLS-23Xi-11-C-R-NPT

(**N**) performance for non-explosive areas; (**11**) insulated (coated) short bar (PP) electrode 30 mm; (**C**) electrically connection with connector; (**R**) NAMUR output type; (**NPT**) process connection with sealing thread 1/2 – 14 NPT.

## 11. ACCESSORIES

**standard** – included in the level sensor price

- 1 pcs. magnetic pen MP-8
- 1 pcs. seal (asbestos free) (Klingerit) \*

\* Pressure resistance - see the table in the accessories datasheet in the "seals and gaskets".

**optional – for a surcharge**

(see catalogue sheet of accessories)

- cable (over the standard length 2m)
- non-detachable connector M12 (variants N, NT) with cable length 2 or 5 m.
- detachable connector M12 with outlet PG7 (variants N, NT)
- normal steel (ON) or stainless steel (NN) welding flange
- stainless steel fixing nut UM–18x1,5
- various types of seals (PTFE, AI, etc.)

## 12. SAFETY, PROTECTION, COMPATIBILITY AND EXPLOSION PROOF

The level sensor is equipped with protection against electric shock on the electrode, reverse polarity, output current overload, short circuit and against current overload on output.

Protection against dangerous contact is provided by low safety voltage according to 33 2000-4-41. Electromagnetic compatibility is provided by conformity with standards EN 55011 / B, EN 61326-1, EN 61000-4-2 (8 kV), -4-3 (10 V/m), -4-4 (2 kV), -4-5 (1 kV) and -4-6 (10 V).

Explosion proof CLS–23Xi and XiT is provided by conformity with standards EN 60079- 0:2013+A11:2014, EN 60079-0:2012.

Explosion proof CLS–23Xi and XiT is verified FTZÚ – AO 210 Ostrava – Radvanice: FTZÚ 12 ATEX 0106X.

A declaration of conformity was issued for this device in the wording of Act No. 90/2016 Coll., as amended. Supplied electrical equipment matches the requirements of valid European directives for safety and electromagnetic compatibility.

### **Special conditions for safe use of variant CLS–23Xi (XiT)**

If the apparatus is used as device of Group II and with using of an approved power supply device, which output parameters comply with required input parameters, it is necessary to have an galvanic separation or in case of apparatus without galvanic separation (Zener barriers) it is necessary to provide equipotential equalizing between sensor and barrier earthing point.

Design CLS–23Xi-11 (12, 20, 21) can be used in zone 0. Other design DLS–23Xi can be used in zone 0 only electrode part and head with electronics can be used only in zone 1.

Ambient temperature:  $T_{amb} = - 20^{\circ}\text{C} \dots +75^{\circ}\text{C}$

Temperature of measured medium according to design variant:

Xi type 10, 12:	(- 25°C to + 105°C)
Xi type 11:	(- 10°C to + 105°C)
Xi type 20, 21, 30, XiT:	(- 30°C to + 150°C)

Maximum temperature of electrodes is equal to temperature of measured medium.

## 13. FUNCTIONAL SAFETY

---

The CLS-23 capacitive level sensors meet the safety integrity level requirements according to standard EN 61508. The sensors are intended for level height detection applications of liquids with increased safety demands in modes:

- Overfill protection
- Dry run protection

In both modes, the sensors meet the requirements for functional safety at level SIL 1.

The sensor electronics have 1oo1 architecture (single-channel without diagnostics).

**It is recommended to perform a function test of the sensor's safety function 1 per year.**

## 14. USE, MANIPULATION AND MAINTENANCE

---

The level meter does not require any personnel for its operation. Maintenance of this equipment consists in verification of integrity of the level meter and of the supply cable.

It is forbidden to make any changes or interventions to the CLS-23 sensor without the consent of the manufacturer. Any repairs must only be carried out by the manufacturer or by a service organization authorised by the manufacturer.

Assembly, installation, commissioning, service and maintenance of the CLS-23 level sensor must be carried out in accordance with the manual and the provisions of valid standards for the installation of electrical equipment must be complied with.

### **Activity during the operation:**

- If the sensor is connected to the automatic control system or to emergency signalling, it must not be infringed in its setting during the operation.
- If a change of the sensor settings is necessary, the whole system must be temporarily switched off and the process held in a safe condition using other means and measures.
- Signalling of failure conditions is described in chapter 8. *Status and failure signalization*

### **Activity in case of a failure:**

- In the event of detected faults or fault signals, the whole system must be shut down and the process held in a safe condition using other means and measures.
- If the replacement of the sensor is needed due to the fault, it is necessary to notify the manufacturer (including a description of the fault).

### **Repairs of the sensors:**

If you need to send the sensor for repair, proceed as follows:

- Remove and clean the sensor or perform its decontamination and wrap it well.
- Write a description of the fault as detailed as possible, attach also a detailed description of the application and of the installation location and everything together with the sensor send please to the address of Dinel s.r.o. company.
- Please provide maximum synergy in finding the root cause of the fault. Your satisfaction is our top priority!

## 15. PUTTING OUT OF OPERATION OR DISPOSAL

---

### **Disassembly:**

Before commencing disassembly, consider possible risks, such as for example pressure in the tank, high temperatures, corrosive properties or toxicity of products, etc.

Carefully read the product manual chapter "Installation instructions" and "Electrical connection" and perform the described steps in reverse sequence.

### **Disposal:**

Capacitative limit sensors CLS-23 are made from materials that can be recycled by specialised companies. Mark the device as waste and dispose of it according to the respective government directive for handling electronic waste. Materials: see "Technical specifications".

## 16. GENERAL CONDITIONS AND WARRANTY

---

Dinel, s.r.o. guarantees for the period of three (3) years that the product has the characteristics as mentioned in the technical specification.

Dinel, s.r.o. is liable for defects ascertained within the warranty period and were claimed in writing.

This guarantee does not cover the damages resulting from misuse, improper installation or incorrect maintenance.

This guarantee ceases when the user or the other person makes any changes on the product or the product is mechanically or chemically damaged, or the serial number is not readable.

The warranty certificate must be presented to exercise a claim.

In the case of a rightful complaint, we will replace the product or its defective part. In both cases, the warranty period is extended by the period of repair.



## 17. MARKING OF LABELS

Labels for device of the type **CLS-23Xi(T)-10; CLS-23Xi(T)-30:**

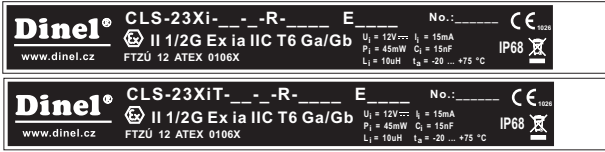

Symbol of producer: logo Dinel®

Internet address: www.dinel.cz

Level sensor type and electrode length: CLS-23Xi(XIT)-\_\_-R-\_\_ Exxxx

Serial number: Ser. No.: \_\_\_\_\_ – (from the left: production year, serial production number)

Mark of non-explosive device: Performance II 1/2G Ex ia IIC T6 Ga/Gb

Limit parameters:  $U_i = 12V$ ,  $l_i = 15mA$ ;  $P_i = 45mW$ ;  $C_i = 15nF$ ;  $L_i = 10\mu H$

Ambient temperature range:  $t_a = -20 \dots +75 \text{ }^\circ C$

Number of certificate of intrinsic safety: FTZÚ 12 ATEX 0106X

Compliance mark:

Protection class: IP68; Electro-waste take-back system mark:

Labels for device of the type **CLS-23Xi(T)-11, 12, 20, 21:**



Symbol of producer: logo Dinel®

Internet address: www.dinel.cz

Level sensor type and electrode length: CLS-23Xi(XIT)-\_\_-R-\_\_ Exxxx

Serial number: Ser. No.: \_\_\_\_\_ – (from the left: production year, serial production number)

Mark of non-explosive device: Performance II 1G Ex ia IIB T6 Ga or II 1/2G Ex ia IIB T6 Ga/Gb

Limit parameters:  $U_i = 12V$ ,  $l_i = 15mA$ ;  $P_i = 45mW$ ;  $C_i = 15nF$ ;  $L_i = 10\mu H$

Ambient temperature range:  $t_a = -20 \dots +75 \text{ }^\circ C$

Number of certificate of intrinsic safety: FTZÚ 12 ATEX 0106X

Compliance mark:

Protection class: IP68, Electro-waste take-back system mark:



Size of labels 81 x 9 mm, the size shown does not correspond to reality.

## 18. TECHNICAL SPECIFICATIONS

TECHNICAL SPECIFICATIONS		
Supply voltage		6 ... 30 V DC
Supply current	– output type P – output type S	max. 0,6 / 7 mA (OFF / ON state) max. 0,6 mA (OFF state)
Switched current	– output type P – output type S	max. 100 mA 3,3 mA / 40 mA (min. / max.)
Remanent voltage - ON state	– output type P – output type S	1,8 V 6,0 V
Output time delay		0,1 s
Protection class		IP68 (0,1 MPa)
Safety integrity level		SIL 1
Cable (for cable outlet performance)	CLS–23N, NT, Xi, XiT CLS–23E	PVC 2x 0,34 mm <sup>2</sup> (3x 0,34 mm <sup>2</sup> – output P) silicone 2x 0,5 mm <sup>2</sup>
Weight (with 2 m cable and 30 mm electrode)	CLS–23N, E, Xi CLS–23NT, XiT	cca. 45 g cca. 190 g

ELECTRICAL PARAMETERS – variants Xi, XiT	
Supply voltage	8 ... 9 V DC
Current supply (state OFF / ON) – NAMUR	≤ 1 mA / ≥ 2,2 mA
Max. internal values	U <sub>i</sub> = 12 V DC; I <sub>i</sub> = 15 mA; P <sub>i</sub> = 45 mW; C <sub>i</sub> = 15 nF; L <sub>i</sub> = 10 μH
Coupling capacity / Electric strength	44 nF / 250 V AC
Reference value of LC parameters of used cable	Typical C < 150 pF/m Typical L < 0,8 μH /m

PROCESS CONNECTION		
Type	Size	Marking
Metric thread	M18x1,5	<b>M18</b>
Metric thread	M20x1,5	<b>M20</b>
Pipe thread (BSP)	G 3/8"	<b>G3/8</b>
Pipe thread (BSP)	G 1/2"	<b>G1/2</b>
Sealing thread	1/2–14	<b>NPT</b>

OUTPUT TYPE	
Output	Variants
S („S“)	N, E, NT
PNP („P“)	N, E, NT
NAMUR („R“)	Xi, XiT

## MATERIAL PERFORMANCE

Sensor part	Variants	Material
Housing	All variants	Plastic PP
Process coupling	All variants	Stainless steel W.Nr. 1.4305 (AISI 303)
Electrode	All variants	Stainless steel W.Nr. 1.4305 (AISI 303)
Electrode insulation	CLS-23_-11	Plastic PP
Electrode insulation	CLS-23_-12, 20, 21	Plastic FEP

## WORKING AREAS AND AREA CLASSIFICATION (EN 60079-10-1)

CLS-23N	Basic performance for non-explosive areas.
CLS-23E	Extended temperature performance for non-explosive areas.
CLS-23NT	High-temperature basic performance for non-explosive areas.
CLS-23Xi (XiT)-10 CLS-23Xi (XiT)-30	Intrinsically safe explosion-proof (XiT - high-temperature) performance for use in hazardous areas (explosive gas atmospheres or explosive atmospheres with dust) $\text{Ex II 1/2 G Ex ia IIC T6 Ga/Gb}$ with intrinsically safe supply units, electrode part zone 0, head zone 1.
CLS-23Xi-11, 12, 20, 21	Intrinsically safe explosion-proof performance for use in hazardous areas (explosive gas atmospheres or explosive atmospheres with dust) $\text{Ex II 1 G Ex ia IIB T6 Ga}$ with intrinsically safe supply units, whole sensor zone 0.
CLS-23XiT-12, 20, 21	Intrinsically safe high-temperature explosion-proof performance for use in hazardous areas (explosive gas atmospheres or explosive atmospheres with dust) $\text{Ex II 1/2 G Ex ia IIB T6 Ga/Gb}$ with intrinsically safe supply units, electrode part zone 0, head zone 1.

## TEMPERATURE AND PRESSURE RESISTANCE – variants Xi, XiT

Variant (Performance)	Temperature tp	Temperature tm	Temperature ta	Max. operating pressure for temperature tp				
				to 30°C	to 85°C	to 105°C	to 130°C	to 150°C
CLS-23Xi-10	-25°C ... +105°C	-25°C ... +105°C	-20°C ... +75°C	8 MPa	6 MPa	5 MPa	–	–
CLS-23XiT-10	-30°C ... +150°C	-30°C ... +150°C	-20°C ... +75°C	8 MPa	6 MPa	5 MPa	4 MPa	3 MPa
CLS-23Xi-11	-10°C ... +105°C	-10°C ... +105°C	-10°C ... +75°C	7 MPa	5 MPa	4 MPa	–	–
CLS-23Xi-12	-25°C ... +105°C	-25°C ... +105°C	-20°C ... +75°C	8 MPa	6 MPa	5 MPa	–	–
CLS-23XiT-12	-30°C ... +150°C	-30°C ... +150°C	-20°C ... +75°C	8 MPa	6 MPa	5 MPa	4 MPa	3 MPa
CLS-23Xi-20	-25°C ... +105°C	-30°C ... +150°C*	-20°C ... +75°C	3 MPa	2,5 MPa	2 MPa	–	–
CLS-23XiT-20	-30°C ... +150°C	-30°C ... +150°C	-20°C ... +75°C	3 MPa	2,5 MPa	2 MPa	1,5 MPa	1 MPa
CLS-23Xi-21	-25°C ... +105°C	-30°C ... +150°C*	-20°C ... +75°C	3 MPa	2,5 MPa	2 MPa	–	–
CLS-23XiT-21	-30°C ... +150°C	-30°C ... +150°C	-20°C ... +75°C	3 MPa	2,5 MPa	2 MPa	1,5 MPa	1 MPa
CLS-23Xi-30	-25°C ... +105°C	-30°C ... +150°C*	-20°C ... +75°C	8 MPa	6 MPa	5 MPa	–	–
CLS-23XiT-30	-30°C ... +150°C	-30°C ... +150°C	-20°C ... +75°C	8 MPa	6 MPa	5 MPa	4 MPa	3 MPa

\* Valid for top mounting (in vertical position)

## TEMPERATURE AND PRESSURE RESISTANCE – variants N, E, NT

Variant (Performance)	Temperature $t_p$	Temperature $t_m$	Temperature $t_a$	Max. operating pressure for temperature $t_p$				
				to 30°C	to 85°C	to 105°C	to 130°C	to 150°C
CLS-23N-10	-25°C ... +105°C	-25°C ... +105°C	-20°C ... +80°C	8 MPa	6 MPa	5 MPa	–	–
CLS-23E-10	-25°C ... +120°C	-25°C ... +120°C	-25°C ... +105°C	8 MPa	6 MPa	5 MPa	–	–
CLS-23NT-10	-30°C ... +150°C	-30°C ... +150°C	-20°C ... +80°C	8 MPa	6 MPa	5 MPa	4 MPa	3 MPa
CLS-23N-11	-10°C ... +105°C	-10°C ... +105°C	-10°C ... +80°C	7 MPa	5 MPa	4 MPa	–	–
CLS-23E-11	-10°C ... +105°C	-10°C ... +105°C	-10°C ... +105°C	7 MPa	5 MPa	4 MPa	–	–
CLS-23N-12	-25°C ... +105°C	-25°C ... +105°C	-20°C ... +80°C	8 MPa	6 MPa	5 MPa	–	–
CLS-23E-12	-25°C ... +120°C	-25°C ... +120°C	-25°C ... +105°C	8 MPa	6 MPa	5 MPa	–	–
CLS-23NT-12	-30°C ... +150°C	-30°C ... +150°C	-20°C ... +80°C	8 MPa	6 MPa	5 MPa	4 MPa	3 MPa
CLS-23N-20	-25°C ... +105°C	-30°C ... +150°C*	-20°C ... +80°C	3 MPa	2,5 MPa	2 MPa	–	–
CLS-23E-20	-25°C ... +120°C	-30°C ... +150°C*	-25°C ... +105°C	3 MPa	2,5 MPa	2 MPa	–	–
CLS-23NT-20	-30°C ... +150°C	-30°C ... +150°C	-20°C ... +80°C	3 MPa	2,5 MPa	2 MPa	1,5 MPa	1 MPa
CLS-23N-21	-25°C ... +105°C	-30°C ... +150°C*	-20°C ... +80°C	3 MPa	2,5 MPa	2 MPa	–	–
CLS-23E-21	-25°C ... +120°C	-30°C ... +150°C*	-25°C ... +105°C	3 MPa	2,5 MPa	2 MPa <td –	–	
CLS-23NT-21	-30°C ... +150°C	-30°C ... +150°C	-20°C ... +80°C	3 MPa	2,5 MPa	2 MPa	1,5 MPa	1 MPa
CLS-23N-30	-25°C ... +105°C	-30°C ... +150°C*	-20°C ... +80°C	8 MPa	6 MPa	5 MPa	–	–
CLS-23E-30	-25°C ... +120°C	-30°C ... +150°C*	-25°C ... +105°C	8 MPa	6 MPa	5 MPa	–	–
CLS-23NT-30	-30°C ... +150°C	-30°C ... +150°C	-20°C ... +80°C	8 MPa	6 MPa	5 MPa	4 MPa	3 MPa

\* Valid for top mounting (in vertical position)

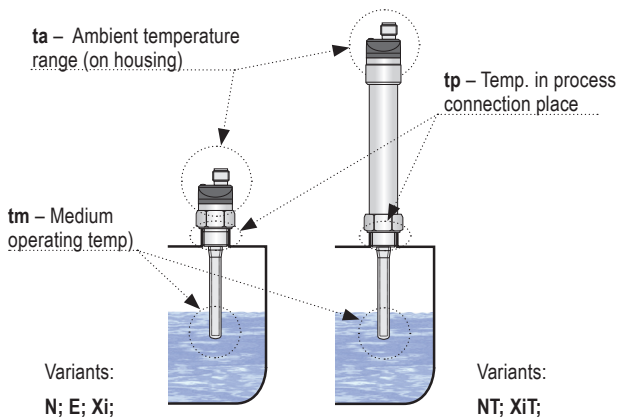

## 19. PACKING, SHIPPING AND STORAGE

---

Equipment CLS-23 is packed in a polyethylene bag and the whole consignment is placed in a cardboard box. The cardboard box is suitably filled to prevent mechanical damage during transport. Let the device packed up till the use to prevent possible damage.

Transport to the customer is realized by forwarding company. Upon receipt, please check whether the shipment is complete and corresponds to the extent of the order, or whether during the transport did not occurred the damage of the packaging or the equipment. The device apparently damaged during transport do not use and contact the manufacturer to resolve the situation.

If the device is transported further, then only wrapped in the original packaging and protected against shocks and weather. Store the device in its original packaging in a dry place, sheltered from the weather, with humidity up to 85% without the effects of chemically active substances. Storage temperature range is from -10 °C to +50 °C.



**Sensor variants CLS-23\_-20, 21 and 30 with the electrodes longer than 100 mm are fitted with protective caps at the ends of the electrodes to prevent damage of the electrodes, box rupture or injury of handling persons. Before commissioning, remove the caps.**





# Dinel<sup>®</sup>

industrial electronics

**Dinel, s.r.o.**  
U Tescomy 249  
760 01 Zlín  
Czech Republic

Phone: +420 577 002 002  
Fax: +420 577 002 007  
E-mail: [sale@dinel.cz](mailto:sale@dinel.cz)

[www.dinel.cz](http://www.dinel.cz)

*Find the updated version at [www.dinel.cz](http://www.dinel.cz)*

*version: 11/2018*



QMS  
ISO 9001

