

## CAPACITIVE PROXIMITY SWITCH CPS-24

---





# CONTENTS

---

1. Basic description .....	4
2. Dimensional drawing.....	5
3. Installation and putting into operation .....	5
4. Installation instructions.....	6
5. Electrical connection .....	7
6. Settings .....	8
7. Function and status indication.....	9
8. Order code .....	9
9. Correct specification examples .....	9
10. Accessories.....	10
11. Safety, protections, compatibility a explosion proof.....	10
12. Use, manipulation and maintenance.....	10
13. General, conditions and warranty .....	11
14. Marking of labels.....	11
15. Specifications .....	13
16. Packings, shipping and storage .....	14

## USED SYMBOLS

---

To ensure maximum safety of control processes, we have defined the following safety instructions and information. Each instruction is labelled with the appropriate pictogram.



### **Alert, warning, danger**

This symbol informs you about particularly important instructions for installation and operation of equipment or dangerous situations that may occur during the installation and operation. Not observing these instructions may cause disturbance, damage or destruction of equipment or may cause injury.



### **Information**

This symbol indicates particularly important characteristics of the device.



### **Note**

This symbol indicates helpful additional information.

## SAFETY

---



**All operations described in this instruction manual have to be carried out by trained personnel or by an accredited person only. Warranty and post warranty service must be exclusively carried out by the manufacturer.**

**Improper use, installation or set-up of the sensor can lead to crashes in the application.**

**The manufacturer is not responsible for improper use, loss of work caused by either direct or indirect damage, and for expenses incurred at the time of installation or during the period of use of the level sensors.**

## 1. BASIC DESCRIPTION

---

**Capacitive proximity switch CPS–24** is intended for detection of proximity or motion of solid objects. It is suitable for indication of the liquid level through non-conductive walls of vessels or on non-conductive gauge-pipes. It is excellent for liquid leakage detection in collection pits or directly on floors. The sensor state is indicated by LED. The sensitivity is adjustable by a trimmer located under a cover screw on the rear side. The design and housing materials of CPS allow the use in complicated environments (harsh, dusty, explosive, aggressive) as well as in clean environments (medical technology).

## 2. DIMENSIONAL DRAWING

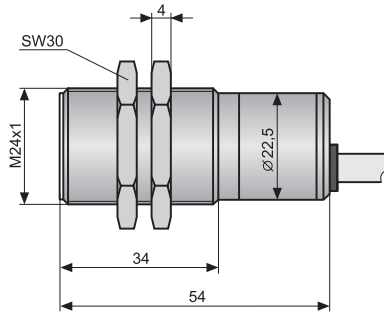

Variant "A" with short cable outlet

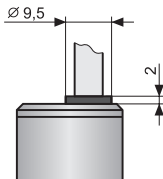

Variant "B" with long cable outlet

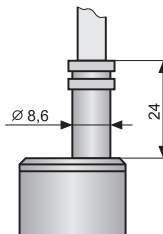

Variant "C" with connector

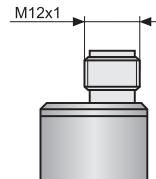

## 3. INSTALLATION AND PUTTING INTO OPERATION

Please follow next 3 steps:

- **INSTALLATION INSTRUCTIONS**
- **ELECTRICAL CONNECTION**
- **SETTINGS**



In the case of the use for an aggressive medium is necessary to prove the chemical compatibility of used materials of the sensor (Tab. Used materials on page 13). This guarantee ceases when the product is chemically damaged.

## 4. INSTALLATION INSTRUCTIONS

Sensing of bulky-solid materials in metal containers or tanks. The position of the sensor is set so that it is approximately 10 mm from the inner wall of a storage tank.

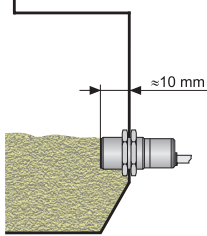

Fig. 1: Sensing bulky-solid materials in storage tanks

Sensor is used for sensing leakages in an interception tank. Leakage indication in detention pits and boxes with "Plate holder PD-24-1".

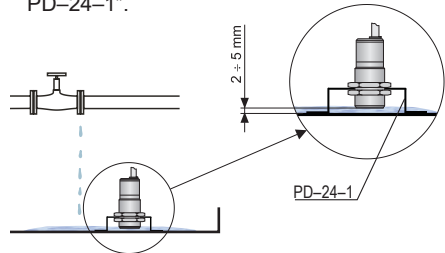

Fig. 2: Use of CPS for sensing leakages in an interception tank

Sensing of moving objects on conveyor. The distance of the sensor from moving objects is set according to their size, shape and material composition (approx. 1 to 8 mm).

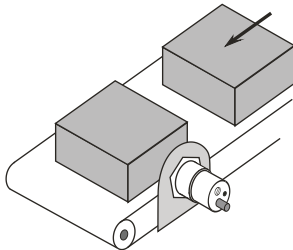

Fig. 3: Sensing objects on a conveyor

Sensor application for level gauges and eye sights. The maximum wall thickness in both cases is up to 10 mm. A glass or plastic level gauge (tube) must have an outer diameter of at least 20 mm. The face of the sensor must be touching the wall.

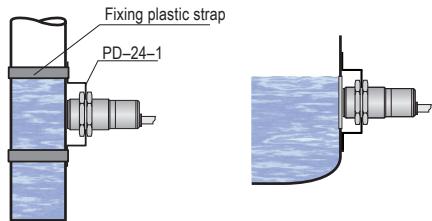

Fig. 4: CPS sensor application for level gauges and eye sights

Detection of liquid presence in the inter-wall space of double-walled storage tanks. The sensor is suspended down into the inter-wall space on its own cable. For this application, we recommend variant „B“ with an extended cable terminal with the installation variant of a PVC hose for cable protection.

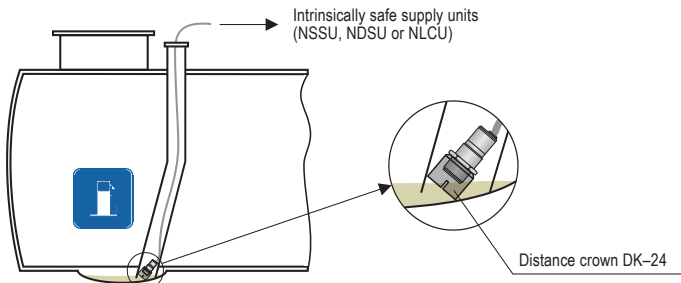

Fig. 5: Use of CPS for indicating presence of liquid in the inter-wall space

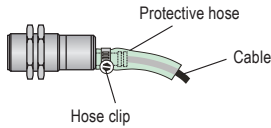

Fig. 6: protective PVC hose

In the case of vertical mounting in outer areas or in the case of high mechanical exertion we recommend to install in Variant "B" **protective hose** on the cable (see figure).

## 5. ELECTRICAL CONNECTION

Sensor with NPN or PNP output is allowed to lead only by resistive or inductive load. Positive supply voltage (+U) is connected to the brown conductor BN (1), negative (0V) to the blue conductor BU (3) and the leads (only NPN or PNP type of output) to the black conductor BK (4). The capacity loads and low resistance loads (bulb) is evaluated by the sensor as short circuit.

The line from CPS-24N to the connecting device is from a suitable three wire (min. 3x0.5 mm<sup>2</sup>) cable, in the case of variant CPS-24Xi using a two wire (min. 2x0.5 mm<sup>2</sup>) cable. In the event that a disassemblable socket ELWIKA or ELKA 4012 K PG7 are used, the max. outer diameter of the cable is 6 mm. Connector socket is not part of the sensor.

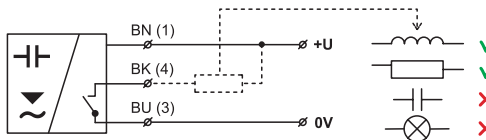

Fig. 7: NPN type sensors connection (version "N")

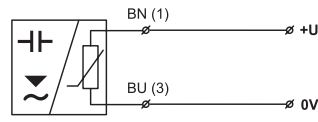

Fig. 8: NAMUR type sensors connection (version "Xi")

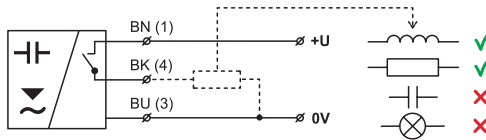

Fig. 9: PNP type sensors connection (version "P")

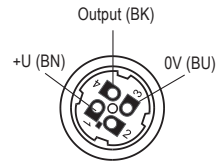

Fig. 10: Inside of the connector socket

### Legend:

- (\*) - Numbers of terminals inside of the connector
- BK - Black
- BN - Brown
- BU - Blue



### Electrical connection can only be made when de-energized!

The source of the power voltage must comprise of a stabilised safe low power source with galvanic separation. In the event that a switch-mode power supply is used, it is essential that its construction effectively suppresses common mode interference on the secondary side. In the event that the switch-mode power supply is equipped with a PE safety terminal, it must be unconditionally grounded! Spark-safe devices (type CPS-24) must be powered from a spark-safe power source meeting the above-mentioned requirements.



Due to the possible occurrence of an electrostatic charge on the non-conductive parts of the sensor, it is necessary to ground all sensors intended for use in environments with an explosion hazard (type CPS-24Xi). This can be performed by grounding el. conductive tanks or el. conductive tank lids, and in the case of el. non-conductive tanks using and grounding an auxiliary plate electrode PDE-27.

In the event that the water level meter (sensor) is installed in an outdoor environment at a distance greater than 20 m from the outdoor switchboard, or from an enclosed building, it is necessary to supplement the electrical cable leading to the water level meter (sensor) with suitable overvoltage protection.

In the event of strong ambient electromagnetic interference, paralleling of conductors with power distribution, or for distribution to distances over 30 m, we recommend using a shielded cable and grounding the shielding on the side of the power source.

## 6. SETTINGS

The sensitivity is set by trimmer located under cover screw on the rear side. Clockwise turning makes the sensitivity lower, reverse direction turning makes the sensitivity higher.

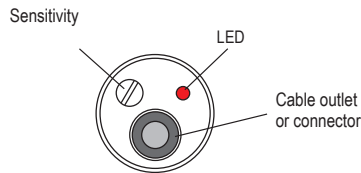

Fig. 11: Top view of level sensor

### SETTING THE BASE SENSITIVITY:

#### a) Type CPS-24 \_ \_ \_ O:

Turn the trimmer to the left until the LED is lit. Then turn slightly to the right until the LED just turns off. From this point, turn 180° to the right.

#### b) Type CPS-24 \_ \_ \_ C:

Turn the trimmer to the left until the LED turns off. Then turn slightly to the right until the LED is lit. From this point, turn 180° to the right.



**After setting the sensitivity, do not forget to properly tighten the trimmer cover screw.**



*The base sensitivity of the sensor is factory set (sensing distance on the metal surface) 8 mm. The actual sensitivity (sensing distance) depends on the dielectric properties or where appropriate the conductivity of the sensed material.*

*For sensing of materials with a low relative permittivity (plastics), we recommend to individually set a higher sensitivity, or consult with the manufacturer if necessary.*



## 7. FUNCTION AND STATUS INDICATION

	Level state	Type of output	Output state	LED indication
Minimum level sensing		CPS-24N-_-NO CPS-24N-_-PO	CLOSED	 (Shine)
		CPS-24Xi-_-RO	HIGHER CURRENT	
		CPS-24N-_-NO CPS-24N-_-PO	OPEN	 (Dark)
		CPS-24Xi-_-RO	LOWER CURRENT	
Maximum level sensing		CPS-24N-_-NC CPS-24N-_-PC	CLOSED	 (Shine)
		CPS-24Xi-_-RC	HIGHER CURRENT	
		CPS-24N-_-NC CPS-24N-_-PC	OPEN	 (Dark)
		CPS-24Xi-_-RC	LOWER CURRENT	

For **minimum level** sensing we recommend sensor with normally open output (NO, PO, RO). It is for failure safety reasons – eventual failure of sensor behaves similarly as an exceeding of the limit state.

Analogically for **maximum level** sensing we recommend normally closed outputs (NC, PC, RC).

For leakage indication we recommend the NC, PC, RC version too. It is **maximum level** sensing as well, despite the sensor is at the lowest place in the room.

## 8. ORDER CODE

CPS-24  -  -  -

Output state at non-activated electrode: **O** – Open (NAMUR – Lower current)  
**C** – Closed (NAMUR – Higher current)

Type of output: **N** – NPN (Open collector)  
**P** – PNP (Open collector)  
**R** – NAMUR

Mech. performance:

**N** – non-explosive areas

**Xi** – for explosive environments

Electric connection:

**A** – Short cable outlet (+ Spec. the length of the cable)

**B** – Long cable outlet (+ Spec. the length of the cable)

**C** – Connector (+ Spec. type of the socket)

## 9. CORRECT SPECIFICATION EXAMPLES

CPS-24N-A-PC cable 4 m

(**N**) Performance for non-explosive areas; (**A**) Short cable outlet with 4 m cable length; (**PC**) Output type PNP with closed state at non-activated electrode

CPS-24Xi-B-RO cable 7 m

(**Xi**) Explosion-proof performance; (**B**) Long cable outlet with 7 m cable length; (**RO**) Output type NAMUR with lower current at non-activated electrode

CPS-24N-C-NO cable 7 m

(**N**) Performance for non-explosive areas; (**C**) Connector; (**NO**) Output type NPN with open state at non-activated electrode

## 10. ACCESSORIES

---

**standard** – included in the level sensor price

- 2 m cable  
(for electric connection type “A” or “B”)
- 2 pcs. of stainless steel fixing nuts
- 1 pcs. Screwdriver for adjustment  
(each 5 pcs.)

**optional – for a surcharge**

(see catalogue sheet of accessories)

- Extra cables over the standard length 2 m  
(for electric connection type “A” or “B”)
- Connector plug (type ELWIKa or ELKA)
- Plate holder PD–24–1
- Distance crown DK–24

## 11. SAFETY, PROTECTIONS, COMPATIBILITY AND EXPLOSION PROOF

---

The level sensor is equipped with protection against electric shock on the electrode, reverse polarity, output current overload, short circuit and against current overload on output.

Protection against dangerous contact is provided by low safety voltage according to EN 33 2000-4-41. Electromagnetic compatibility is provided by conformity with standards EN 55 022/B, EN 61326-1/Z1, EN 61000-4-2, EN 61000-4-3, EN 61000-4-4, EN 61000-4-6.

Explosion proof CPS-24Xi is provided by conformity with standards EN IEC 60079-0:2018, EN 60079-11:2012.

Explosion proof CPS-24Xi is verified FTZÚ Ostrava – Radvanice: FTZÚ 02 ATEX 0233X

A declaration of conformity was issued for this device in the wording of Act No. 90/2016 Coll., as amended. Supplied electrical equipment matches the requirements of valid European directives for safety and electromagnetic compatibility.

### **Special conditions for safe use of variant CPS-24Xi**

The level sensor is designed to be connected with supply unit type NSSU, NDSU and NLCU. If some other approved apparatus is used, its output parameters comply with above mentioned parameters, then it is necessary to include galvanic separation and/or in case of application of apparatus without galvanic separation (Zener safety barriers) it is necessary to provide equipotential equalisation between sensor and point of barrier earthing.

Ambient temperature:  $-20^{\circ}\text{C} \leq T_a \leq +70^{\circ}\text{C}$

Intrinsically safe parameters:

$U_i = 12\text{ V}$ ;  $I_i = 15\text{ mA}$ ;  $P_i = 45\text{ mW}$ ;  $C_i = 28\text{ nF}$ ;  $L_i = 10\text{ }\mu\text{H}$

## 12. USE, MANIPULATION AND MAINTENANCE

Detection of approach or assessment of the movement of solid objects, level indication in electrically non-conductive storage tanks (plastic, glass) and level gauges. Limit sensing of non-abrasive bulk-solid materials (cereals, grains, granulates, sand, etc.) in metal storage tanks. Detection of the presence of liquids in the inter-wall area of double-walled storage tanks, liquid leakage detection in interception traps, concrete sumps or directly on the floor.



We do not recommend using for the measurement of el. conductive liquids that leave a continuous film on the inner wall of an el. non-conductive storage tank or level gauge and liquids that exude el. conductive particles that deposit themselves on the wall of a storage tank or level gauge (e.g. heavily mineralised water, chemically treated waste water). Likewise, the sensor is also not intended for measuring levels on level gauges and walls of storage tanks with antistatic treatment (partially electrically conductive).

## 13. GENERAL, CONDITIONS AND WARRANTY

Dinel, s.r.o. guarantees for the period of three (3) years that the product has the characteristics as mentioned in the technical specification.

Dinel, s.r.o. is liable for defects ascertained within the warranty period and were claimed in writing.

This guarantee does not cover the damages resulting from misuse, improper installation or incorrect maintenance.

This guarantee ceases when the user or the other person makes any changes on the product or the product is mechanically or chemically damaged, or the serial number is not readable.

The warranty certificate must be presented to exercise a claim.

In the case of a rightful complaint, we will replace the product or its defective part. In both cases, the warranty period is extended by the period of repair.

## 14. MARKING OF LABELS

Labels for device of the type CPS-24N-\_-NO, CPS-24N-\_-NC, CPS-24N-\_-PO, CPS-24N-\_-PC:

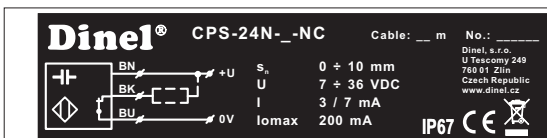
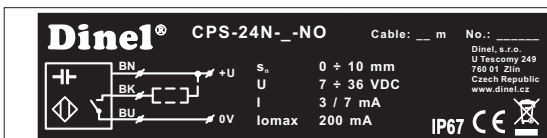

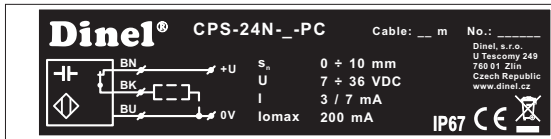
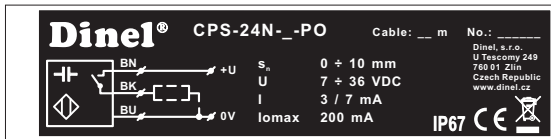

Symbol of producer: logo Dinel®

Contact: Dinel, s.r.o., U Tescomy 249, 760 01 Zlín, Czech Republic, www.dinel.cz

Connection scheme and labelling of wires: +U, 0 V

Type of level meter: CPS-24N-\_-NO, CPS-24N-\_-NC, CPS-24N-\_-PO, CPS-24N-\_-PC

Cable length: Cable: \_\_ m

Serial number: Ser. No.: \_\_\_\_\_ – (from the left: production year, serial production number)

sensitivity range of sensor  $S_n$ : 0-10 mm

Supply voltage range U: 7-36 V DC, Supply current I: 3 / 7 mA

Maximum output current  $I_{omax}$ : 200 mA

Coverage: IP6\_ (Protection class according to electrical connection)

Compliance mark: **CE**

Electro-waste take-back system mark:

Labels for device of the type **CPS-24Xi-\_-R\_** :



Symbol of producer: logo Dinel®

Contact: Dinel, s.r.o., U Tescomy 249, 760 01 Zlín, Czech Republic, www.dinel.cz

Connection scheme and labelling of wires: +U, 0 V

Type of level meter: CPS-24Xi-\_-R\_

Cable length: Cable: \_\_ m

Serial number: Ser. No.: \_\_\_\_\_ – (from the left: production year, serial production number)

Mark of non-explosive device:

Limit parameters:  $U_i=12VDC$ ,  $I_i=15mA$ ,  $P_i=45mW$ ,  $C_i=28nF$ ,  $L_i=10\mu H$

Ambient temperature range :  $t_a = -20 \dots +70 \text{ }^\circ\text{C}$

Number of certificate of intrinsic safety: FTZÚ 02 ATEX 0233X

Coverage: IP6\_ (Protection class according to electrical connection)

Compliance mark: **CE** , No. of authorized person examining control of system quality: 1026

Electro-waste take-back system mark:

Size of labels 70 x 20 mm, the size shown does not correspond to reality.

## 15. SPECIFICATIONS

### TECHNICAL SPECIFICATIONS

Supply voltage	7 ... 36 V DC *	
Current supply (state OFF / ON)	3 / 6 mA *	
Switching current (NPN, PNP output)	200 mA *	
Electric strength	500 V AC	
Coupling capacity	2.2 nF	
Max. switching frequency	5 Hz	
Sensitivity – sensing distance	0 ... 10 mm (adjustable)	
Hysteresis	5 ... 15 %	
Ambient temperature range	-20 ... +70 °C	
Protection class	IP67	
Cable (version with cable outlets)	CPS–24N CPS–24Xi	PVC 3 x 0.5 mm <sup>2</sup> PVC 2 x 0.75 mm <sup>2</sup>
Weight (incl. 2 m cable)	Approx. 0.3 kg	

\* Only for variants "N"

### ELECTRICAL PARAMETERS – variant Xi

Supply voltage	8 ... 9 V DC (Max. 12 V DC)
Current supply (state OFF / ON) – NAMUR	≤ 1 mA / ≥ 2.2 mA
Max. internal values	U <sub>i</sub> = 12 V DC; I <sub>i</sub> = 15 mA; P <sub>i</sub> = 45 mW; C <sub>i</sub> = 28 nF; L <sub>i</sub> = 10 μH

### WORKING AREAS (EN 60079-0, EN 60079-10-1(2))

CPS–24N	Basic performance for non-explosive atmospheres.
CPS–24Xi	Intrinsically safe explosion-proof performance for use in hazardous areas (explosive gas atmospheres or explosive atmospheres with dust),  II 1G Ex ia IIC T6 Ga with intrinsically safe supply units, whole sensor zone 0.

### USED MATERIALS

Part of the sensor	Material
Housing	St. steel W.Nr. 1.4301
Sensing surface	PTFE
Ending	St. steel W.Nr. 1.4301
Cable outlet (Variant "A")	Plastic POM
Cable outlet (Variant "B")	St. steel W.Nr. 1.4301

### TYPE OF OUTPUT

Output	Variants
NPN ("NC", "NO")	N
PNP ("PC", "PO")	N
NAMUR ("RC", "RO")	Xi

## 16. PACKINGS, SHIPPING AND STORAGE

---

The device CPS-24 is packaged in a polyethylene bag, and the entire consignment is placed into a cardboard box. A suitable filler material is used in the cardboard box to prevent mechanical damage during transport. Remove the device from the packaging only just before using, thereby protecting it from potential damage.

A forwarding company will be used to ship goods to the customer. Upon prior agreement, ordered goods can be picked up in person at company headquarters. When receiving, please check to see that the consignment is complete and matches the order, or to see if any damage has occurred to the packaging and device during transport. Do not use a device clearly damaged during transport, but rather contact the manufacturer in order to resolve the situation.

If the device is to be further shipped, it must be wrapped in its original packaging and protected against impact and weather conditions.

Store the device in its original packaging in dry areas covered from weather conditions, with humidity of up to 85% without effects of chemically active substances. The storage temperature range is -10 °C to +50 °C.



# Dinel<sup>®</sup>

industrial electronics

**Dinel, s.r.o.**  
U Tescomy 249  
760 01 Zlín  
Czech Republic

Phone: +420 577 002 002  
E-mail: [sale@dinel.cz](mailto:sale@dinel.cz)

[www.dinel.cz](http://www.dinel.cz)

*Find the updated version at [www.dinel.cz](http://www.dinel.cz)  
version: 04/2022*

