

- Universal use for limit level sensing of liquids and bulk solids
- Direct mounting into tanks, vessels, sumps and tubes or silos and hoppers
- Setting using a magnetic pen
- Mode for quick sensor setting without the presence of medium
- Optical indication by two LEDs
- Wide selection of connections: connector or cable glands
- Housing, electrodes and reference tubes made from stainless steel
- High stability upon high sensitivity (possible to use for materials with $\epsilon_r \geq 1.3$)



Capacitive level sensors DLS[®] are designed for limit sensing of the level of liquid and bulk solids in tanks, sumps, tubes or, hoppers, silos, etc. The sensors are manufactured in several modifications of sensing electrodes (rod and rope). The electrodes can be given an insulating coating, a useful feature in case of adhesive, aggressive or conductive media sensing. Rod electrodes are also available in a version with reference tube for measuring fluids in tanks made from non-conductive material.

Sensors are manufactured in the following configurations: **N** – for non-explosive areas, **Xi** – Explosion proof – intrinsically safe for hazardous (explosive) areas and **XiM** – Explosion proof – intrinsically safe for use in mines with methane or flammable dust presence danger (see technical specifications). There are high temperature performance **NT**, **XiT**, **XiMT** available. DLS are offered in variants with various types of process connection (metric and pipe thread, pressure thread NPT).

VARIANTS OF SENSORS

- **DLS-35_-10** **Uncoated short bar electrode** for sensing non-adhesive bulk solids (sand, sugar) and non-conductive liquids (petroleum products, oils), horizontal mounting. Electrode length 50 mm or 100 mm.
- **DLS-35_-13** like DLS-35_-10, but higher pressure resistance
- **DLS-35_-20** **Semi-coated rod electrode** for sensing slightly adhesive bulk solids (cement, flour) and non-conductive liquids (plant oils), horizontal, slant or vertical mounting. Electrode length from 0.1 m to 2 m.
- **DLS-35_-21** **Fully coated rod electrode (FEP insulation)** for sensing conductive liquids (water solutions, water), adhesive and aggressive materials, horizontal or vertical mounting. Electrode length from 0.1 m to 2 m.
- **DLS-35_-22** **Fully coated rod electrode (PFA insulation)** with enhanced resistance to permeation (diffusion) of vapours and gases. For sensing the level of water and other conductive liquids in the food, pharmaceutical and chemical industries. In the short term can be used for high temperature applications (e.g. hot steam sanitation), or for volatile aggressive liquids, etc. Horizontal or vertical mounting. Electrode length 0.1 m ... 2 m.
- **DLS-35_-25** like DLS-35_-22, but higher pressure and mechanical resistance at high temperature. Suitable for high temperature applications (hot steam), etc. Electrode length 0.1 m ... 2 m.
- **DLS-35_-30** **Dismountable uncoated rod electrode** for sensing bulk solids and conductive or non-conductive liquids. Vertical or horizontal slant mounting. Electrode length 0.1 m ... 3 m.
- **DLS-35_-31** **Fully coated rod electrode (FEP insulation)**, for sensing aggressive conductive liquids (water, various chemicals). Vertical mounting. Electrode length from 0.1 m to 3 m.
- **DLS-35_-40** **Uncoated rod electrode with reference tube (coaxial electrode)**, for sensing non-conductive liquids (petroleum products, oil) in non-conductive tanks. Vertical mounting. Maximum electrode length 1 m.
- **DLS-35_-41** **Fully coated rod electrode (FEP insulation) with reference tube (coaxial electrode)**, for sensing conductive liquids in non-conductive tanks. Vertical mounting. Maximum electrode length 1 m.
- **DLS-35_-50** **Uncoated rope electrode and weight**, for general purpose use in deeper silos (bulk solids sensing – sand, gravel, cement) or sumps (sensing liquids). Vertical mounting. Electrode length from 1 m to 6 m.

DIMENSIONAL DRAWINGS

DLS-35_-10, 13

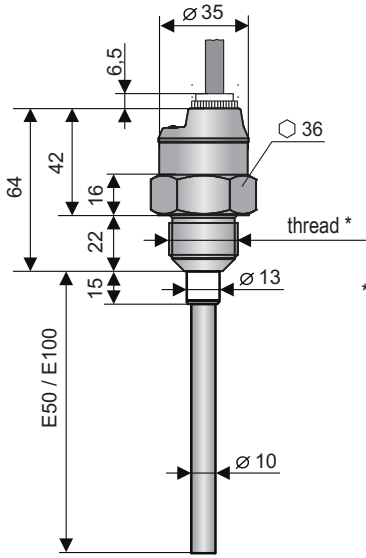

* Type of threads:
 G 1"
 G 3/4"
 M27x2
 M30x1,5
 NPT 3/4

DLS-35_-20

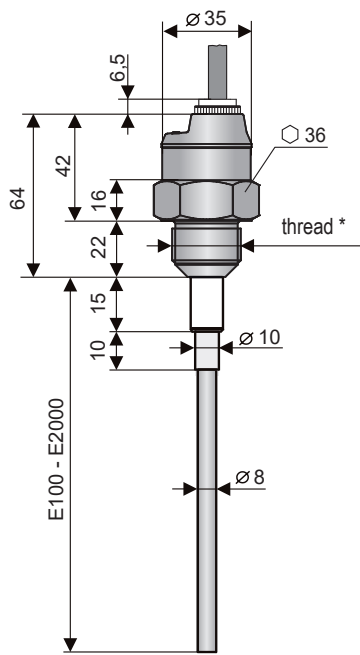

DLS-35_-21, 22, 25

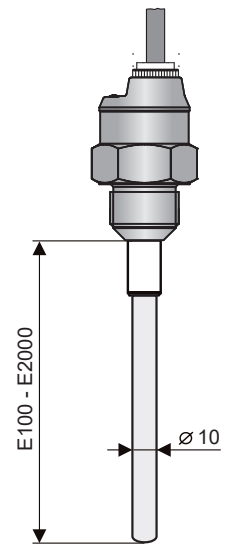

DLS-35_-30

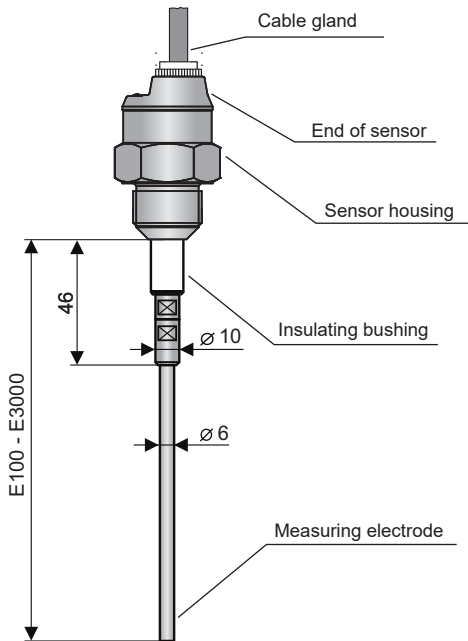

DLS-35_-31

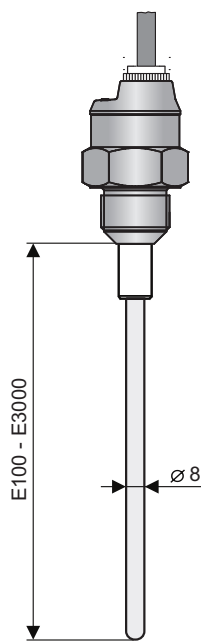

DLS-35_-40

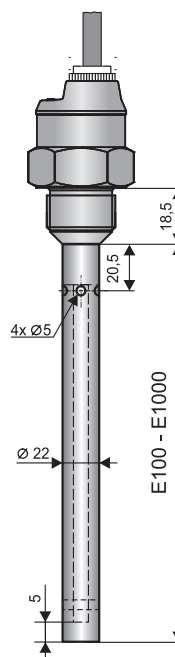

DLS-35_-41

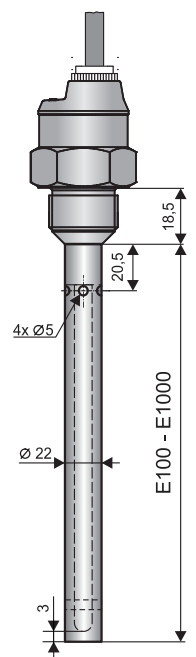

DLS-35_ -50

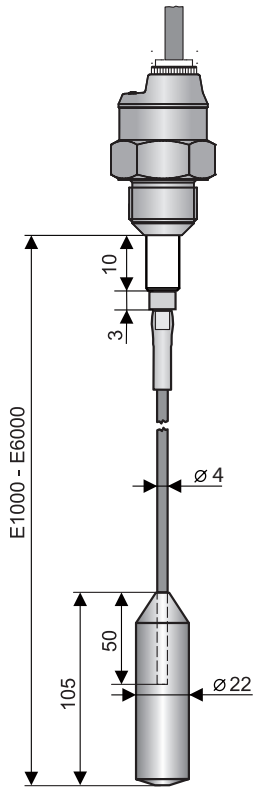

High temperatures variants

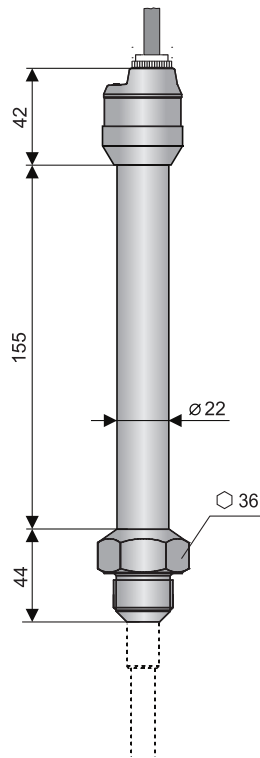

Variant "A" with short stainless steel gland

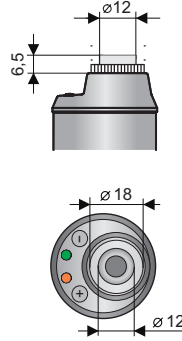

Variant "C" with connector M12

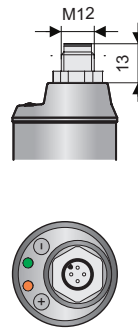

Variant "B" with plastic threaded cable gland

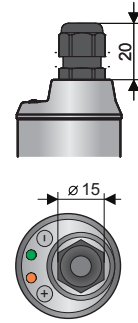

Variant "D" with dustproof cable outlet

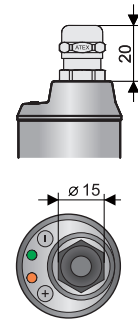

Variant "V" with plastic cable gland with spiral relief - for case of increased mechanical wear on the cable.

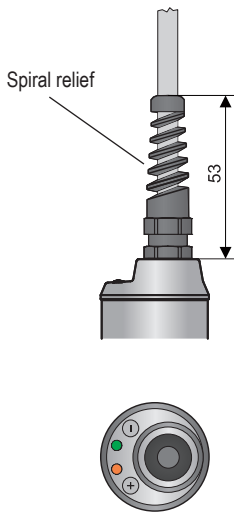

Variant "H" with cable gland for protected hoses - for using in an outdoor area or in area with increased moisture.

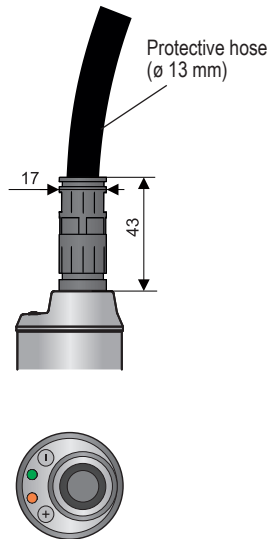

Process connection Tri-clamp

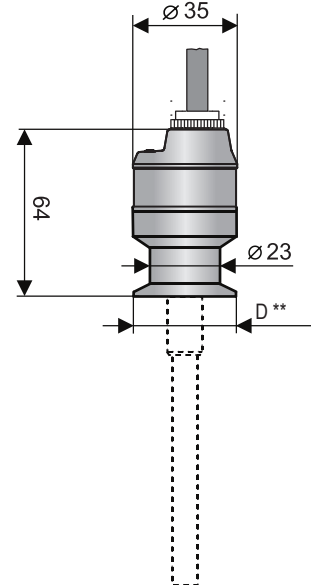

** D: Tri-Clamp C134 (ø 34 mm)
Tri-Clamp C150 (ø 50,5 mm)

All dimensions are in mm

TECHNICAL SPECIFICATIONS

BASIC TECHNICAL DATA

Power consumption (variant DLS-35N(T))	7 ... 34 V DC
Power consumption (variant DLS-35N(T))	max. 5 mA
Max. switching current (NPN, PNP output)	300 mA
Residual voltage – ON state	max. 1,5 V
Input resistance / electric strength	1 MΩ / 200 V DC
Coupling capacity (housing - power) / dielectric strength	50 nF / 350 V AC
Coupling capacity (electrode - power) / dielectric strength	47 nF / 350 V AC
Protection class type DLS-35-__-C-__ type DLS-35-__-A(B,V,H)-__	IP67 IP68
Cable (versions with cable outlets)	PVC 3 x 0,5 mm ²
Weight (excl. electrode and cable) variant N variant NT	cca 0,3kg cca 0,6kg

ELECTRICAL PARAMETERS (variant Xi, XiT, XiM, XiMT)

Power supply voltage	8 ... 9 V DC
Current consumption (disconnected/ connected) – NAMUR	≤ 1 mA / ≥ 2,2 mA
Limit values	Ui = 12 VDC; li = 15 mA; Pi = 45 mW; Ci = 15 nF; Li = 10 μH
Reference value LC for the parameters of the used cable	typic C < 150 pF/m typic L < 0,8 μH /m

USED MATERIALS

sensor part	variants	standard material *
Wetted parts:		
Housing	all types except Tri-clamp Tri-clamp	stainless steel W.Nr. 1.4301 (AISI 304) stainless steel W.Nr. 1.4404 (AISI 316L)
Rod electrode	all types except DLS-35-50, DLS-35-10 DLS-35-10	stainless steel W.Nr. 1.4404 (AISI 316L) stainless steel W.Nr. 1.4301 (AISI 304)
Rope electrode	DLS-35-50	stainless steel W.Nr. 1.4401 (AISI 316)
Reference tube	DLS-35-40, 41	stainless steel W.Nr. 1.4301 (AISI 304)
Insulating bushing	DLS-35-10, 20, 21, 22, 30, 31, 40, 41 DLS-35-13, 50	PTFE PPS + GF40
Electrode coating	DLS-35-21, 31, 41 DLS-35-22, 25	FEP PFA
Sealing O-ring	DLS-35-13	FPM (Viton)
Weight	DLS-35-50	stainless steel W.Nr. 1.4301 (AISI 304)
No wetted parts:		
Cable gland	DLS-35-__-A DLS-35-__-B DLS-35-__-D DLS-35-__-V DLS-35-__-H	stainless steel W.Nr. 1.4571 (AISI 316 Ti)/NBR plastic PA / NBR nickel-plated brass / PA / rubber CR / NBR plastic PA / NBR plastic PA / NBR
Connector M12	DLS-35-__-C	nickel-plated brass / PA

* It is always necessary to verify the chemical compatibility of the material with the measured medium. You can also choose another type of material after agreement.

PROCESS CONNECTION

type	size	marking
Pipe thread	G 1"	G 1
	G 3/4"	G3/4
Metric thread	M27x2	M27
	M30x1,5	M30
Taper pipe thread	NPT 3/4	NPT
Jointless connection (Tri-Clamp)	ø 34 mm	CI34
	ø 50,5 mm	CI50

TYPE OF OUTPUT

Output	Variants
NPN (N)	N, NT
PNP (P)	N, NT
NAMUR (R)	Xi, XiM, XiT, XiMT

WORKING AREAS AND AREA CLASSIFICATION (EN 60079-0, EN 60079-10-1(2))

DLS-35N	Basic performance for non-explosive atmospheres.
DLS-35NT	High-temperature basic performance for non-explosive atmospheres.
DLS-35Xi	Intrinsically safe explosion-proof performance for use in hazardous areas (explosive gas atmospheres or explosive atmospheres with dust), $\text{Ex II 1 G Ex ia IIB T6 Ga}$; $\text{Ex II 1 D Ex ia IIIC T80°C Da}$ with intrinsically safe supply units, whole sensor zone 0 and 20.
DLS-35XiT	Intrinsically safe high-temperature explosion-proof performance for use in hazardous areas (explosive gas atmospheres or explosive atmospheres with dust), $\text{Ex II 1/2 G Ex ia IIB T6 Ga/Gb}$; $\text{Ex II 1/2 D Ex ia IIIC T80°C Da/Db}$ with intrinsically safe supply units, electrode part zone 0 and 20, head zone 1 and 21.
DLS-35XiM	Intrinsically safe explosion-proof performance for use in mines with the occurrence of methane or coal dust $\text{Ex I M1 Ex ia I Ma}$ with intrinsically safe supply units.
DLS-35XiMT	Intrinsically safe high-temperature explosion-proof performance for use in mines with the occurrence of methane or coal dust $\text{Ex I M1 Ex ia I Ma}$ with a safe supply units.

TEMPERATURE RESISTIVITY (variant N, NT, Xi, XiM, XiT, XiMT)

variant	temperature t_m	temperature t_p	temperature t_a
DLS-35N-10	-40°C ... +100°C	-40°C ... +85°C	-40°C ... +85°C
DLS-35N-13	-40°C ... +200°C	-25°C ... +85°C	-40°C ... +85°C
DLS-35N-20, 30	-40°C ... +300°C	-40°C ... +85°C	-40°C ... +85°C
DLS-35N-21, 22, 31, 40, 41	-40°C ... +200°C	-40°C ... +85°C	-40°C ... +85°C
DLS-35N-25	-40°C ... +200°C	-40°C ... +85°C	-40°C ... +85°C
DLS-35N-50	-40°C ... +250°C	-40°C ... +85°C	-40°C ... +85°C
DLS-35NT-10, 20, 30	-40°C ... +300°C	-40°C ... +200°C	-40°C ... +85°C
DLS-35NT-13	-40°C ... +200°C	-25°C ... +200°C	-40°C ... +85°C
DLS-35NT-21, 22, 31, 40, 41	-40°C ... +200°C	-40°C ... +200°C	-40°C ... +85°C
DLS-35NT-25	-40°C ... +200°C	-40°C ... +200°C	-40°C ... +85°C
DLS-35NT-50	-40°C ... +250°C	-40°C ... +200°C	-40°C ... +85°C
DLS-35Xi,XiM-10	-40°C ... +100°C	-40°C ... +75°C	-40°C ... +75°C
DLS-35Xi,XiM-13	-40°C ... +200°C	-25°C ... +75°C	-40°C ... +75°C
DLS-35Xi,XiM- 20, 30	-40°C ... +300°C	-40°C ... +75°C	-40°C ... +75°C
DLS-35Xi,XiM- 21, 22, 31, 40, 41	-40°C ... +200°C	-40°C ... +75°C	-40°C ... +75°C
DLS-35Xi,XiM-25	-40°C ... +200°C	-40°C ... +75°C	-40°C ... +75°C
DLS-35Xi,XiM-50	-40°C ... +250°C	-40°C ... +75°C	-40°C ... +75°C
DLS-35XiT,XiMT-10, 20, 30	-40°C ... +300°C	-40°C ... +200°C	-40°C ... +75°C
DLS-35XiT,XiMT-13	-40°C ... +200°C	-25°C ... +200°C	-40°C ... +75°C
DLS-35XiT,XiMT-21, 22, 31, 40, 41	-40°C ... +200°C	-40°C ... +200°C	-40°C ... +75°C
DLS-35XiT,XiMT-25	-40°C ... +200°C	-40°C ... +200°C	-40°C ... +75°C
DLS-35XiT,XiMT-50	-40°C ... +250°C	-40°C ... +200°C	-40°C ... +75°C
DLS-35XiM (XiMT) - mine application	Max. 150°C on any surface where the coal-dust can form layers		

Note: For the correct operation of the level sensor, none of the here provided temperature ranges may be exceeded (t_p , t_m or t_a). The here-mentioned temperatures are visually explain in Fig. 8.

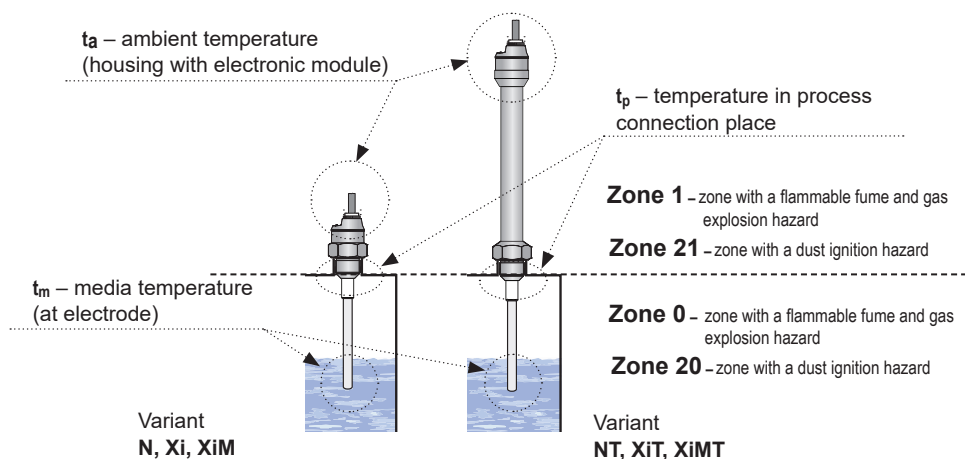

Illustration of areas for temperature measurement and explosive zones

PRESSURE RESISTIVITY (variant N, NT, Xi, XiM, XiT, XiMT)

variant	max. operating pressure for temperature tp				
	up to 30°C	up to 85°C	up to 120°C	up to 150°C	up to 200°C
DLS-35N-10	5 MPa (50 bar)	2,5 MPa (25 bar)	–	–	–
DLS-35N-13	7,5 MPa (75 bar)	5 MPa (50 bar)	–	–	–
DLS-35N-20, 30	5 MPa (50 bar)	2,5 MPa (25 bar)	–	–	–
DLS-35N-21, 22, 31, 40, 41	5 MPa (50 bar)	2,0 MPa (20 bar)	–	–	–
DLS-35N-25	2,0 MPa (20 bar)	2,0 MPa (20 bar)	–	–	–
DLS-35N-50	0,1 MPa (1 bar)	0,1 MPa (1 bar)	–	–	–
DLS-35NT-10, 20, 30	5 MPa (50 bar)	2,5 MPa (25 bar)	1,5 MPa (15 bar)	1 MPa (10 bar)	0,5 MPa (5 bar)
DLS-35NT-13	7,5 MPa (75 bar)	5 MPa (50 bar)	4,5 MPa (45 bar)	4 MPa (40 bar)	3,5 MPa (35 bar)
DLS-35NT-21, 22, 31, 40, 41	5 MPa (50 bar)	2,0 MPa (20 bar)	1,5 MPa (15 bar)	1 MPa (10 bar)	0,1 MPa (1 bar)
DLS-35NT-25	2,0 MPa (20 bar)	2,0 MPa (20 bar)	2,0 MPa (20 bar)	2,0 MPa (20 bar)	2,0 MPa (20 bar)
DLS-35NT-50	0,1 MPa (1 bar)	0,1 MPa (1 bar)	0,1 MPa (1 bar)	0,1 MPa (1 bar)	0,1 MPa (1 bar)
DLS-35Xi,XiM-10	5 MPa (50 bar)	2,5 MPa (25 bar)	–	–	–
DLS-35Xi,XiM-13	7,5 MPa (75 bar)	5 MPa (50 bar)	–	–	–
DLS-35Xi,XiM- 20, 30	5 MPa (50 bar)	2,5 MPa (25 bar)	–	–	–
DLS-35Xi,XiM- 21, 22, 31, 40, 41	5 MPa (50 bar)	2,0 MPa (20 bar)	–	–	–
DLS-35Xi,XiM-25	2,0 MPa (20 bar)	2,0 MPa (20 bar)	–	–	–
DLS-35Xi,XiM-50	0,1 MPa (1 bar)	0,1 MPa (1 bar)	–	–	–
DLS-35XiT,XiMT-10, 20, 30	5 MPa (50 bar)	2,5 MPa (25 bar)	1,5 MPa (15 bar)	1 MPa (10 bar)	0,5 MPa (5 bar)
DLS-35XiT,XiMT-13	7,5 MPa (75 bar)	5 MPa (50 bar)	4,5 MPa (45 bar)	4 MPa (40 bar)	3,5 MPa (35 bar)
DLS-35XiT,XiMT-21, 22, 31, 40, 41	5 MPa (50 bar)	2,0 MPa (20 bar)	1,5 MPa (15 bar)	1 MPa (10 bar)	0,1 MPa (1 bar)
DLS-35XiT,XiMT-25	2,0 MPa (20 bar)	2,0 MPa (20 bar)	2,0 MPa (20 bar)	2,0 MPa (20 bar)	2,0 MPa (20 bar)
DLS-35XiT,XiMT-50	0,1 MPa (1 bar)	0,1 MPa (1 bar)	0,1 MPa (1 bar)	0,1 MPa (1 bar)	0,1 MPa (1 bar)

INSTALLATION INSTRUCTIONS

- DLS® level sensors can be fixed in a vertical, horizontal or slanted position into the wall of a vessel, storage tank or on a fixation console in a sump by screwing into the welding flange, using a fixing nut or TriClamp® process connection.
- In case of vertical mounting, sensors can be mounted into open, closed and pressurized tanks. The stated distances relate to the electrode length (longer electrode).

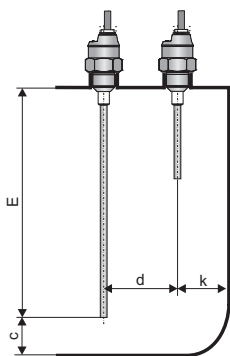

Vertical mounting

All vertically mounted sensors

$$c \geq 10 + \frac{E}{50}$$

$$d \geq 40 + \frac{E}{40}$$

$$k \geq 20 + \frac{E}{20}$$

E- Electrode length in mm

- In the case of **side wall mounting**, it is necessary to avoid long fitting tubes, where sensed medium could accumulate (fig. on right). We recommend mounting the sensor so that the whole sensing electrode and insulation is inside the storage tank (Fig. on left).

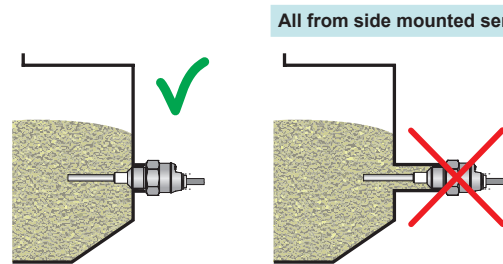

Correct and incorrect installation with a long tube

- In case of side wall mounting, place the sensor outside the flow of bulk solids or liquids.

All side mounted sensors

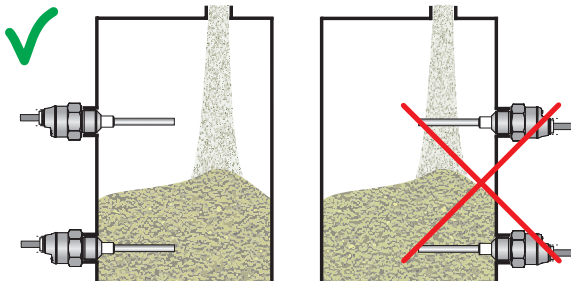

Correct and incorrect installation into storage tank side wall

- Protective roof cover is recommended to prevent mechanical damage of the sensor electrode when **vertical movement of material** could damage the sensing electrode (abrasive materials, bulk-solid materials forming blocks, piece goods).

For: DLS-35_-10, 13, 20,

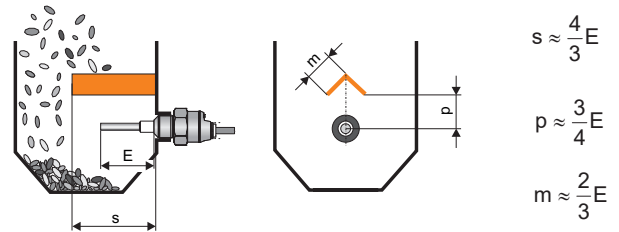

Protective roof mounting

- In the case of **slant wall mounting** it is necessary to eliminate **fitting tubes**, thereby reducing medium sedimentation. The wrong example of mounting is shown in Fig. on the left. The appropriate mounting on the auxiliary vertical plate is shown in the middle. In some cases the variant is allowed as shown in Fig. on the right. But this is recommended only for measuring bulk-solid materials by a sensor of the DLS-35_-10 type, which do not mechanically damage the electrode and do not form separate blocks.

For: DLS-35_-10, 13, 20

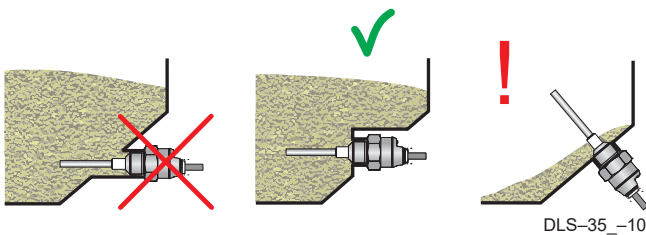

Slant wall mounting

- In case of **vertical installation** for sensing the level of **unknown (conductive and non-conductive) liquids** in tanks or sumps, it is appropriate to bend the electrode into a right angle. This will increase the local sensitivity and accuracy of sensing the level at the spot of the bend.
- When weather conditions (wind, rain, snow) clearly influence the electrode (open sumps), we recommend using types with an insulated electrode (DLS-35_-21,22,25,31).

For: DLS-35_-30

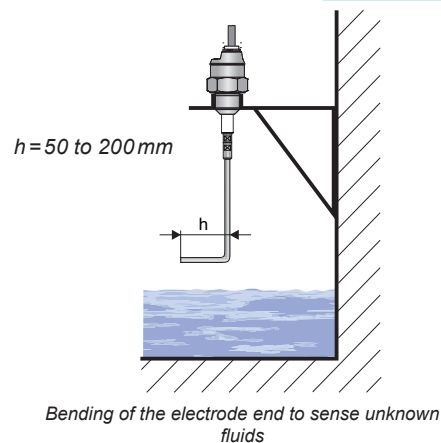

- Mounting in a **bypass measuring tube**. We recommend upholding the tube diameter.

For: DLS-35_-20, 21, 22, 25, 30, 31

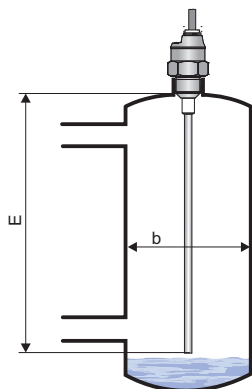

Bypass measuring tube

$$b \geq 40 + \frac{E}{20}$$

E- Electrode length in mm

- In the case of **mounting in the pipe** it is necessary to provide the minimum distance of the inner walls from the electrode at 5 mm. In some cases (sticky liquids, low permittivity liquids) it is better to mount the sensor into a pipe bend.

For: DLS-35_-10, 13, 21, 22, 25

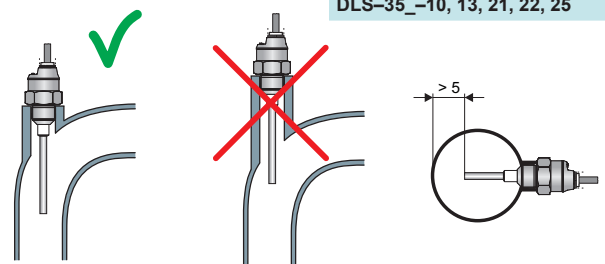

Sensor mounting in a tube

- In case of vertical mounting, it is possible to use the sensor for simple two-state regulation of the level height between a min. and max. value. The position of the minimum and maximum level can be changed by setting the sensor. Upon a change in the measured medium, it is necessary to perform new limit settings.

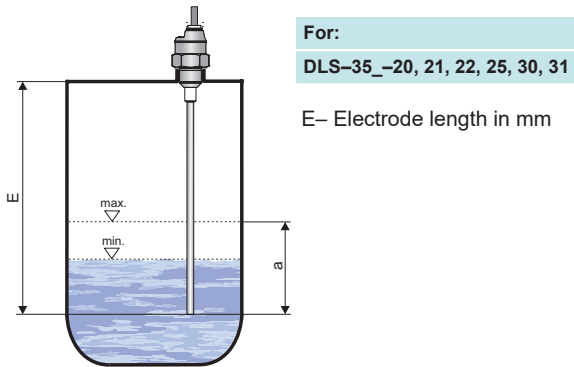

Two-state level regulation by hysteresis setting

- In the case of **vertical mounting** especially on existing tanks, it is necessary to select the pipe length as short **as possible** to avoid vapour condensation, or sedimentation of impurities. A similar situation occurs when the sensing electrode goes through the concrete ceiling of the silo. The hole diameter should be at least 50 mm (based on ceiling thickness).

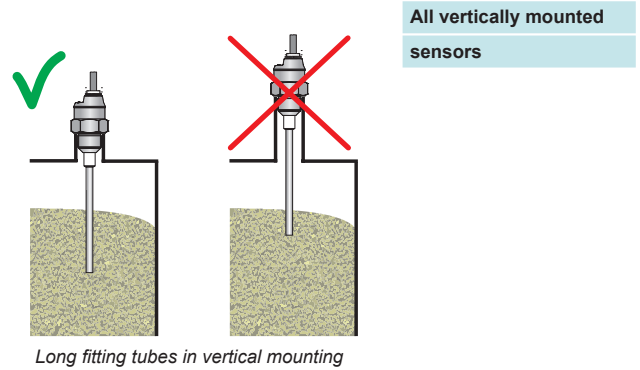

ELECTRICAL CONNECTION

The positive pole of the supply voltage (+U) is connected to the brown wire BN or pin connector no.1, the negative pole (0V) is connected to the blue wire BU or pin connector no. 3 and load on the black wire BK or pin connector no. 4. The sensor assesses capacitive loads and low resistance loads (lamp) to be a short circuit.

Connection diagrams are listed in Figures.

Note: In case of strong ambient electromagnetic interference, paralleling of conductors with power distribution, or for the distribution to distance over 30 m, we recommend using shielded cable.

Sensors DLS-35 with type of cable outlet A, B, D, V or H are connected to assessing units permanently connected by PVC cable.

The sensors DLS-35 with connection method type C are connected to assessing units by means of a connector socket with compression cable (length 2 or 5 m), or by means of a connector socket without cable (see accessories), the connector is not part of the sensor. In this case the cable is connected to the inside pins of the socket according to the figure on the right. The recommended diameter of this cable is 4 to 6 mm (the recommended cross-sectional area is 0.5 to 0.75 mm²).

The connection of the sensor to the connecting device is performed using a suitable three wire (variant N) or two wire (variant Xi, XiT, XiM, XiMT) cable. With models Xi, XiT, XiM, XiMT, the length of the cable needs to be selected respecting the maximum permissible parameters (namely induction and capacity) of the outer spark-safe circuit of the power supplies (NSSU, NDSU, NLCU).

In the event that connector sockets that can be disassembled are used, the outer diameter of the cable is max. 6 mm.

A sensor with NPN or PNP output can be loaded only by resistive or inductive load.

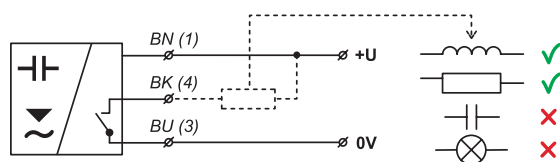

NPN output type sensor connection (configuration N, NT)

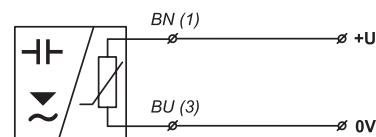

Connection of a sensor with a NAMUR type output (configuration Xi, XiM, XiT, XiMT)

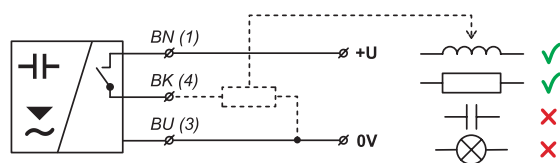

PNP output type sensor connection (configuration N, NT)

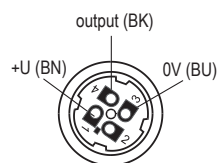

Inside of the connector socket

Legend:

(1,...) – numbers of terminals inside the connector socket

BK – Black

BN – Brown

BU – Blue



Electrical connection can only be made when de-energized!

The source of the power voltage must comprise of a stabilised safe low power source with galvanic separation. In the event that a switch-mode power supply is used, it is essential that its construction effectively suppresses common mode interference on the secondary side. In the event that the switch-mode power supply is equipped with a PE safety terminal, it must be unconditionally grounded! Spark-safe devices type DLS-35Xi (XiT, XiM, XiMT) must be powered from a spark-safe power source meeting the above-mentioned requirements.



Due to the possible occurrence of an electrostatic charge on the non-conductive parts of the sensor, it is necessary to ground all sensors intended for use in environments with an explosion hazard DLS-35Xi (XiT, XiM, XiMT). This can be performed by grounding el. conductive tanks or el. conductive tank lids, and in the case of el. non-conductive tanks using and grounding an auxiliary plate electrode PDE-27.

In the event that the level meter (sensor) is installed in an outdoor environment at a distance greater than 20 m from the outdoor switchboard, or from an enclosed building, it is necessary to supplement the electrical cable leading to the level meter (sensor) with suitable overvoltage protection.

In the event of strong ambient electromagnetic interference, paralleling of conductors with power distribution, or for distribution to distances over 30 m, we recommend using a shielded cable and grounding the shielding on the side of the power source.

SETTINGS

Settings are performed by touching a magnetic pen on sensitive spot indicated as “+” or “-” located beside the connector or cable gland. This method is used to set the sensitivity to the measured medium, switching (O, C), with or without the presence of medium. The third function is designed for fine-tuning the sensor sensitivity. The fourth function is designed for hysteresis setting. Upon a change in the measured medium, it is necessary to perform new limit settings.

For detailed information please read at the instructions manual.

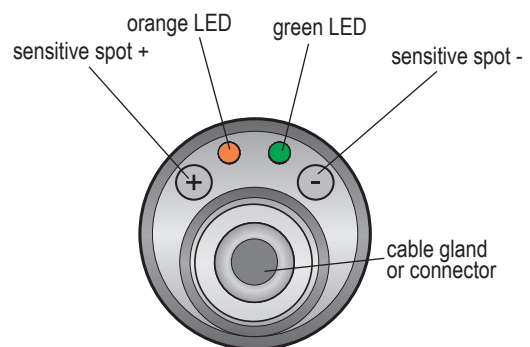

Top view of level sensor

RANGE OF APPLICATION AND INSTALLATION OF INDIVIDUAL VARIANTS

DLS-35 -10, 13

Produced in two versions – with 50 mm or 100 mm electrode. The shorter version (E50) is suitable for clean non-conductive liquids level sensing (oils, diesel, petrol, etc.). The longer version (E100) is designed for non-adhesive bulk solids or non-adhesive powder materials (plastic granulates, sand, sugar, grains, detergents, etc.) and other slightly impure, non-conductive liquids (lubricants, plant oils). The sensor is specified to be mounted directly into a vessel or storage tank wall (best by horizontal position) by means of welding flanges or stainless steel fixing nuts. In case of level sensing of low-permittivity media in non-metal storage tanks, we recommend mounting the sensor on an auxiliary metal-plate electrode with min. area of 200 cm². Variant “13” has higher pressure and mechanical resistance.

DLS-35 -20

Designed for limit level detection of bulk solids with low specific weight and permittivity (cement, hydrated lime, flour), and for materials expected to have changing properties (fly ash, sawdust, feed mixtures, etc.). It is possible to use it for sensing non-conductive liquids containing a small amount of water (up to 2%) or other impurities (plant oils, liquid propane, etc.). The sensor is mounted directly into the wall of a vessel or storage tank using steel welding flanges or fixing nuts horizontally, slanted from the side or vertically. It is recommended to mount a sensor with an electrode longer than 300 mm only in the vertical position. Hollow spaces should be minimized between the electrode and the wall where the sensed material can accumulate (see application notes). In non-metal storage tanks, we recommend mounting the sensor on an auxiliary metal-plate electrode with min. area of 400 cm².

DLS-35 -21, 22, 25

Specified for conductive liquids level sensing (water, water solutions, mud, etc.). It reacts to partial or full immersion of the electrode (depending on the adjusted sensitivity). The lower the sensitivity, the higher the sensor's resistance to contaminants and clinging remnants of material. The sensor with electrode length of up to 200mm can be desensitized to complete water immersion, so it can be operated in the horizontal position. The sensor can be operated in the vertical position with any length up to 1 m. The sensor is mounted directly into the wall of the tank in horizontal or vertical position by applying a steel or stainless steel welding flange. For variant “22” and „25“, the material PFA is used to insulate the electrode. This variants are more resistant to vapor and gas diffusion and to volatile aggressive liquids. Variants “25” have higher pressure resistance at high temperatures and is particularly suitable for hot water, aqueous solutions and steam.

DLS-35 -30

Designed for sensing conductive and non-conductive liquids and bulk solids. It is not recommended to install the sensor into closed vessels (storage tanks) where intensive water vapour condensation occurs. The sensor reacts to electrically conductive liquids just by touch of the end of electrode. To react to a non-conductive liquid (bulk solid), it is necessary to have $5 \div 20\%$ immersion of the electrode according to the sensor's adjusted sensitivity and permittivity of the sensed material. The sensor is mounted directly into a tank, hopper or sump in slant or vertical position by means of welding flange or stainless steel fixing nut. In non-metal storage tanks, we recommend mounting the sensor on an auxiliary metal-plate electrode with min. area of 500 cm^2 .

DLS-35 -31

Designed for limit level detection of conductive liquids (water and solutions of various chemicals). It is possible to place the sensor electrode into closed vessels (storage tanks), open canals and sumps. The sensor reacts to the conductive fluid level after $2 \div 20\%$ immersion of the electrode based on the sensor's set sensitivity. The sensor is mounted vertically directly into a vessel, tank or open (concrete, plastic) sumps by means of welding flanges or fixing nuts. When installing the sensor into open sumps, it is necessary to secure conductive connection of the sensor housing with the sensed liquid. It is possible to use a metal structure, armouring or another auxiliary electrode. If you must sense an aggressive medium in a closed plastic container, contact the manufacturer.

DLS-35 -40

Designed for sensing conductive and non-conductive liquids in non-metal storage tanks. It is not recommended to install the sensor into closed vessels (storage tanks) where intensive water vapour condensation occurs. The sensor reacts to electrically conductive liquids just by touch of the end of electrode. To react to non-conductive liquid, it is necessary to have $5 \div 20\%$ immersion into a medium based on the sensitivity set on the sensor and the permittivity of the sensed material. The sensor is mounted directly into a tank, hopper or sump in slant or vertical position by means of welding flange or stainless steel fixing nut.

DLS-35 -41











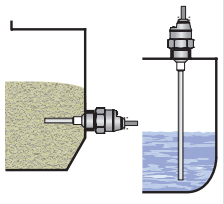

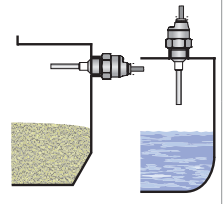

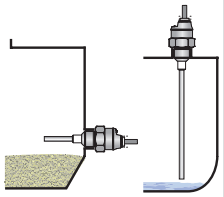

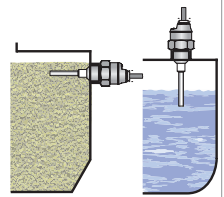
Designed for sensing conductive liquids (water and water solutions of various chemicals) in non-metal storage tanks. The measuring part of the sensor can be installed into closed vessels (storage tanks), open channels and sumps. The sensor reacts to the conductive liquid level after $2 \div 20\%$ immersion of the electrode based on the sensor's set sensitivity. The sensor is mounted vertically directly into a vessel, tank or open (concrete, plastic) sumps by means of welding flanges or fixing nuts. If you must sense an aggressive medium in a closed plastic container, contact the manufacturer.

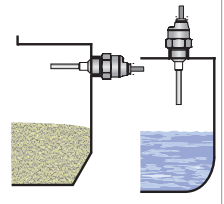
DLS-35 -50

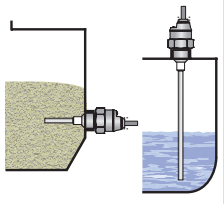
For sensing conductive and non-conductive liquids and bulk solids at greater depths (sewerage sumps, shafts, wells, cement storage tanks, sand, gravel, etc.). It is not appropriate to place the sensor electrode into closed containers (storage tanks) where intensive condensation of water vapour occurs. The sensor reacts to electrically conductive liquids just by touch of the end of electrode. To react to non-conductive liquid or bulk solid, a $5 \div 20\%$ immersion into the material is necessary based on the sensitivity set on the sensor and the permittivity of the sensed material. The sensor is mounted vertically directly into the wall of a storage tank or sump. For open (concrete) sumps, it can be mounted on an auxiliary metal structure conductively connected with the sensed material. For mounting, you can use supplied welding flanges or fixing nuts.

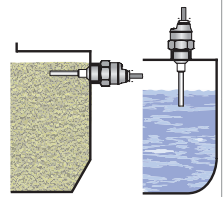
FUNCTION AND STATUS INDICATION

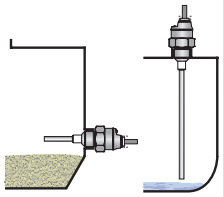
LED indicator	colour	function
"RUN"	green	<p>Measuring function indication</p> <p>flashing – (repeats according to the period of measuring approx. 0.5 s) – correct function of level detection</p> <p>dark – incorrect installation or malfunction. LED is dark too, if the function setting is running.</p> <p>alternating flashing of the green and orange LED – error in settings (the sensor did not recognize states for open and closed)</p>
"STATE"	orange	<p>Settings indication</p> <p>permanent shine – the sensor is closed</p> <p>dark – the sensor is open</p> <p>3 short flashes – settings confirmed</p> <p>simultaneous shine of green and orange LED – when applying the mag. pen, when the setting is confirmed</p>

	level state	mode	output state	LED indicator		level state	mode	output state	LED indicator
minimum level sensing		O	CLOSED (with type N, NT)			C	CLOSED (with type N, NT)		
			HIGHER CURRENT (with type Xi, XiT, XiM and XiMT)	(illuminated)				HIGHER CURRENT (with type Xi, XiT, XiM and XiMT)	(illuminated)
		O	OPEN (with type N, NT)			C	OPEN (with type N, NT)		
			LOWER CURRENT (with type Xi, XiT, XiM and XiMT)	(not illuminated)				LOWER CURRENT (with type Xi, XiT, XiM and XiMT)	(not illuminated)
maximum level sensing		C	CLOSED (with type N, NT)			O	CLOSED (with type N, NT)		
				HIGHER CURRENT (with type Xi, XiT, XiM and XiMT)			(illuminated)		HIGHER CURRENT (with type Xi, XiT, XiM and XiMT)
		C	OPEN (with type N, NT)			O	OPEN (with type N, NT)		
				LOWER CURRENT (with type Xi, XiT, XiM and XiMT)			(not illuminated)		LOWER CURRENT (with type Xi, XiT, XiM and XiMT)

For safety reasons, we recommend using the mode "O" for min. level sensing (the sensor closes upon immersion). It is for failure safety reasons – eventual failure of sensor behaves similarly as an exceeding of the limit state. Analogically, for the max. level, we recommend setting the mode "C" (the sensor opens upon immersion).

ORDER CODE

DLS-35

MECH.ANICAL PERFORMANCE

N	non-explosive areas
NT	high temperature performance
Xi	for explosive environments ☹
XiM	for mining environments ☹
XiT	high-temperature conf. for explosive environments ☹
XiMT	high-temperature conf. for mining environments ☹

TYPE AND PERFORMANCE OF ELECTRODE

10	short bar, uncoated, lengths 50 or 100 mm
13	like 10, but higher pressure resistance
20	rod, uncoated coated, length 0.1 ... 2 m
21	rod, coated (FEP), length 0.1 ... 2 m
22	rod, coated (PFA), length 0.1 ... 2 m
25	like 22, but higher pressure and mechanical resistance at high temperatures
30	rod, uncoated coated, length 0.1 ... 3 m
31	rod, coated (FEP), length 0.1 ... 3 m
40	rod, uncoated with ref. tube, length 0.1 ... 1 m
41	rod, coated (FEP) with ref. tube, length 0.1 ... 1 m
50	rope with weight, uncoated, length 1 ... 6 m

PROCESS CONNECTION

G1	pipe thread G 1"
G3/4	pipe thread G 3/4"
M27	metric thread M 27x2
M30	metric thread M 30x1.5
NPT	pressure thread NPT 3/4
CI34	Tri-clamp (ø 34 mm)
CI50	Tri-clamp (ø 50,5 mm)

TYPE OF OUTPUT

N	NPN (open collector)
P	PNP (open collector)
R	NAMUR (change in supply current)

CONNECTION METHOD

A	stainless steel compression gland + cable
B	plastic threaded cable gland + cable
C	connector (socket not included with sensor, recommended type - see accessories)
D	metal dust proof terminal + cable
V	plastic cable gland with spiral + cable
H	plastic cable gland for protective hose + cable

ELECTRODE

E	electrode length in mm
----------	------------------------

CABLE

K	cable length in m
----------	-------------------

DLS-35 N - 20 - G1 - N - A E50 K5 SAMPLE OF ORDER CODE

CORRECT SPECIFICATION EXAMPLES

DLS-35N-10- M27-N- B E100 cable 5 m

(N) non-explosive areas; (10) uncoated short bar electrode; (M27) process connection by thread M27; (N) output type NPN; (B) plastic threaded cable gland; (E100) electrode length 100 mm

DLS-35NT-21-G3/4-P-C E580

(N) non-explosive areas; (21) coated bar electrode (FEP); (G3/4) process connection by thread G3/4"; (P) output type PNP; (C) connector; (E580) electrode length 580 mm.

DLS-35N-40-M30-P-V E1420

(N) non-explosive areas; (40) uncoated rod electrode with reference tube; (M30) process connection by thread M30; (P) output type PNP; (C) connector; (E1420) electrode length 1420 mm.

DLS-35Xi-10- M27-R- B E100 cable 5 m

(Xi) high-temperature conf. for explosive environments; (10) uncoated short bar electrode; (M27) process connection by thread M27; (R) output type NAMUR; (B) plastic threaded cable gland; (E100) electrode length 100 mm.

DLS-35N-22- CI50-P-A E200 cable 5 m

(N) non-explosive areas; (22) coated bar electrode (PFA); (CI50) process connection Tri-clamp (\varnothing 50,5 mm); (P) output type PNP; (A) stainless steel compression gland; (E200) electrode length 200 mm.

ACCESSORIES

standard - included in the level sensor price

- 1 pcs. magnetic pen MP-8
- 1 pcs. seal (asbestos free) *

* Pressure resistance - see the table in the accessories datasheet in the "seals and gaskets".

optional – for a surcharge (see catalogue sheet of accessories)

- cable (over the standard length 2m)
- connector socket (type ELWIKa or ELKA)
- normal steel welding flange or stainless steel welding flange
- protective hose (for type of cable outlet H)
- stainless steel fixing nut
- various types of seals (PTFE, Al, etc.)

SAFETY, PROTECTIONS, COMPATIBILITY AND EXPLOSION PROOF

The level sensor is equipped with protection against electric shock on the electrode, reverse polarity, output current overload, short circuit and against current overload on output.

Protection against dangerous contact is provided by low safety voltage according to EN 33 2000- 4- 41. Electromagnetic compatibility is provided by conformity with standards EN 55022/B, EN 61326-1, EN 61000-4-2 to -8.

Explosion proof DLS-35Xi (XiT, XiM, XiMT) is provided by conformity with standards EN 60079-0, EN 60079-11, EN 60079-26.

Explosion proof DLS-35Xi (XiT, XiM, XiMT) is verified FTZÚ – AO 210 Ostrava – Radvanice: FTZÚ 16 ATEX 0140X.

A declaration of conformity was issued for this device in the wording of Act No. 90/2016 Coll., as amended. Supplied electrical equipment matches the requirements of valid European directives for safety and electromagnetic compatibility.

Special conditions for safe use of variant DLS-35Xi (XiT, XiM, XiMT)

Sensors DLS-35Xi(XiT, XiM, XiMT) are intended for connection to approved spark-safe power supply unit circuits (of insulating transducers) with galvanic separation. In the event that devices without galvanic separation are used (Zener barriers), it is necessary to balance the potential between the sensor, resp. level meter and the barrier grounding location.

The limit output parameters of spark-safe units (insulating transducers) must correspond to the limit input parameters of the sensor. When assessing spark-free safety of circuits, it is necessary to also take into consideration the parameters of the connected cable (namely its induction and capacity).

The DLS-35Xi configuration may be located in zone 0 or zone 20. With the DLS-35XiT configuration it is only possible to locate the electrode part in zone 0 and in zone 20, and then the head with the electronics in zone 1 or zone 21.

Ambient temperature: $T_{amb} = -40^{\circ}\text{C}$ to $+75^{\circ}\text{C}$.

The temperature of the measured material according to the variant configuration, see chapter "Technical parameters". The maximum temperature of the electrodes equals the temperature of the measured material.

With the DLS-35XiMT configuration, it is necessary to ensure that the temperature of any surface, where coal dust may accumulate layers, does not exceed 150°C .

version 02/2022