

- For liquids limit level sensing on non-conductive (glass or plastic) gauge-pipes, tubes and tank walls
- The sensor is equipped with high frequency technology, which allows reliable operation even for sensing of the adherent electrically conductive medium
- Miniature performance in plastic housing, LED state indication
- Simple sensitivity setting by means of magnetic pen
- Variants with fixed cable or a connector
- Two-wire connection directly to the relay circuit or PLC input



Through wall level switches **GPLS-25** are intended for liquid (conductive and non-conductive) level detection on glass or plastic gauge-pipes, tubes and tanks. The sensitivity and modes (SO – normally open or SC – normally closed) of the switches can be easily set by placing magnetic pen on sensitive spot. The connection is done by means of two wires directly into a circuit with relay or to binary input of control system.

FEATURES OF VARIANTS

- **GPLS-25N-0** **Prismatic (refracted) electrode**, shape-adapted to be attached to the gauging pipe or other tube. The fixing of the sensor onto a pipe is provided by plastic straps.
- **GPLS-25N-1** **Planar electrode**, suitable for installation on flat surfaces (e.g. plastic or glass tanks). The sensor can be fixed with plastic straps or by double sided adhesive layer.

DIMENSIONS DRAWINGS

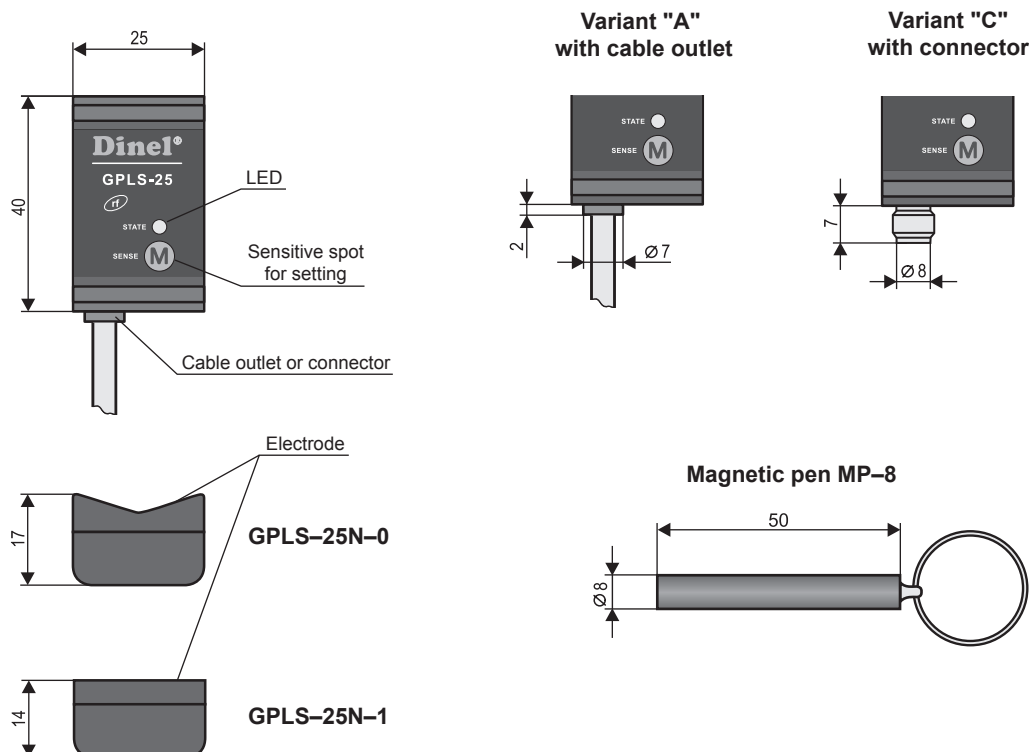

TECHNICAL SPECIFICATIONS		
Supply voltage		6 ... 30 V DC
Supply current	– Output type P – Output type S	Max. 0.6 / 7 mA (OFF / ON state) Max. 0.6 mA (OFF state)
Switched current (Min. / Max.)	– Output type P – Output type S	100 mA 3.3 mA / 40 mA
Remanent voltage – ON state	– Output type P – Output type S	1.8 V 6.0 V
Switching frequency		Max. 1 Hz
Max. thickness of the vessel wall	– Conductive liquids – Non-conductive liquids with $\epsilon_r < 10^*$	8 mm 3 mm
Ambient temperature range		-20 ... +80°C
Temperature range at the tube or vessel surface / with double-side self adhesive tape		-20 ... +90°C / +60°C
Housing material		Plastic (PP)
Protection class		IP67
Connection cable type (Variants "A")	– Output type P – Output type S	PVC 3x0.34 mm ² PVC 2x0.34 mm ²
Weight (including 2 m cable)		Approx. 60 g

*) ϵ_r see "Table of dielectric constants"

RECOMMENDED RANGE OF APPLICATION

Detection of various types of liquids - water, disel, oil, cooling liquids, water solutions, some types of solvents. It is suitable for glass or plastic gauge-pipes, vessels, plastic container tanks, plastic tubs, pools, canisters, etc.

UNSUITABLE RANGE OF APPLICATION

The sensor also is not intended for level measurement on the gauge-pipe and the container wall with antistatic treatment (partially electrically conductive).

INSTALLATION AND RECOMMENDATIONS

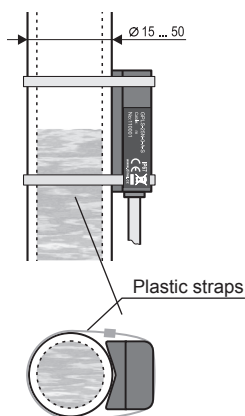

Point level detection on **plastic or glass gauge pipes and tubes**. The sensor is fixed to the gauge pipe or tube by means of two plastic straps (2.5 mm width). The cable should be vertically downwards oriented. The maximum wall thickness of the tube depends on the detected medium (see technical data); the maximum is 8 mm.

Applies to:

GPLS-25N-0

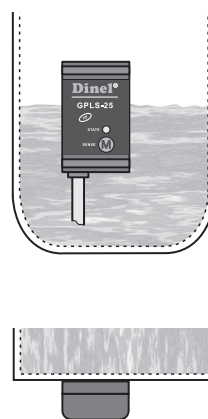

Thru-wall level sensing of liquids in **plastic or glass vessels with flat walls**. The sensor is installed on a clean and degreased surface of the vessel wall. The attachment is done by double-sided adhesive layer. Orientation of the sensor can be arbitrary. Maximum thickness of the vessel wall depends on the detected medium (see technical data); the maximum is 8 mm.

Applies to:

GPLS-25N-1

ELECTRICAL CONNECTION

GPLS-25N--S

Positive pole (+ U) of power supply is connected through a load (relay) to brown wire or pin connector No. 1, negative pole is connected to white wire or pin connector No. 3.

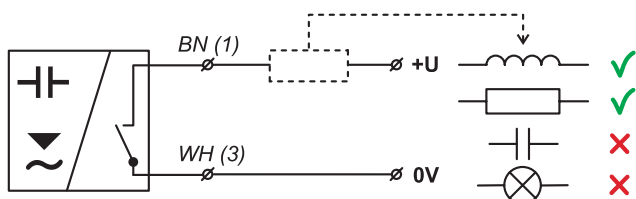

Connection scheme of sensor with "S" type output

GPLS-25N--P

Positive pole (+ U) of power supply is connected to brown wire or pin connector No. 1, negative pole is connected to blue wire or pin connector No. 3. Load (relay) is connected to black wire or pin connector No. 2.

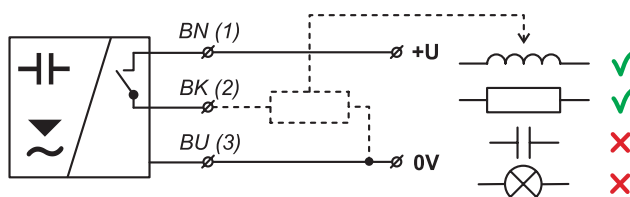

Connection scheme of sensor with "PNP" type output

Note:

The sensor output is protected against short circuits. Capacity loads and loads with low sleep resistance (bulb) the sensor evaluates as a short circuit.

In case of high ambient electromagnetic interference, parallel conductors with power lines, or lines at distances greater than 30 m, we recommend to use shielded cable.

Legend:

- (1)... – Terminals number for variants with connector
- BN – Brown
- WH – White
- BU – Blue

SENSOR SETTINGS

The setting is done by placing of magnetic pen MP-8 to sensitive spot (M) located on the front of the sensor. Short time attaching (up to 2 sec.) of the magnetic pen to the sensitive spot (M) makes the sensor open. Long attach (at least 4 sec.) of the pen when the level is changed, defines closed state of the sensor. In this way the sensitivity for the measured medium and switching modes "S" (normally open) or "C" (normally closed) is set. When changing the fluid it is necessary to make the new setting.

mode O
(normally open)

When the level is low (the container is empty), attach the magnetic pen MP-8 to the sensitive spot (M) for short time (max. 2 sec.). When the level is high (the container is full), attach the magnetic pen MP-8 to the sensitive spot (M) for long time (min. 4 sec.).

mode C
(normally close)

When the level is low (the container is empty), attach the magnetic pen MP-8 to the sensitive spot (M) for long time (min. 4 sec.). When the level is high (the container is full), attach the magnetic pen MP-8 to the sensitive spot (M) for short time (max. 2 sec.).

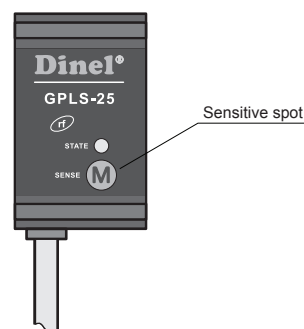

FACTORY DEFAULT SETTINGS:

Type **GPLS-25** is set to detect to detect water and switching mode "O" (normally open state).

STATUS SIGNALIZATION

Indicator	Function
Orange LED	Continuous light – Sensor is closed (switched ON)
	Dark – Sensor is open (switched OFF)
	Rapid flashing (period 0.2 sec.)* – Unrecognized upper and lower limits or setting mistake
	Slow flashing (period 0.8 sec.) – Short circuit at sensor output

* Sensor with "S" type output, for each flash of the LED switches its output on for approx. 3 ms. This period is sufficiently short to avoid unwanted switching of relay contacts. For binary inputs, we recommend to set the filter so as not to respond to pulses shorter than 3 ms.

ORDER CODE

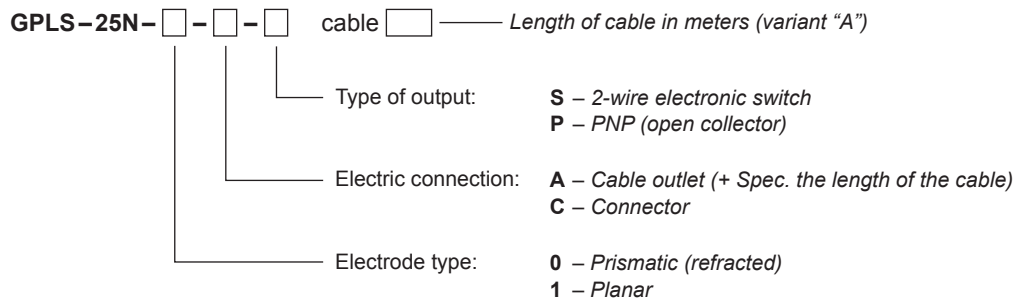

CORRECT SPECIFICATION EXAMPLES

GPLS-25N-1-A-P cable 5 m

(1) planar electrode, (A) cable outlet with 5 m length fixed cable; (P) output type PNP.

GPLS-25N-0-C-S

(0) prismatic electrode, (C) electric connection with connector; (S) output type S (electronic switch).

ACCESSORIES

Standard – included in the level sensors price

- 2 pcs of Plastic straps 2.5 x 200 mm
- 1 pc of Double-side self adhesive tape (GPLS-25N-1)
- 1 pc of Magnetic pen MP-8

Optional – for extra charge

- Connector ELKA KV 3308

SAFETY, PROTECTIONS AND COMPATIBILITY

The level sensor is equipped with a protection against electric shock on electrode, polarity, overvoltage and short-term current overload on the output.

Electromagnetic compatibility is provided by conformity with standards EN 55022/B, EN 61326-1, EN 61000-4-2, -3, -4 and -6.