



## HYDROSTATIC LEVEL METERS HLM-35

---



Before the first use of the level meter, read the instructions in this manual and keep it carefully. The manufacturer reserves the right to make alterations without a prior notice.



# CONTENTS

---

1. Basic description .....	4
2. Range of application .....	4
3. Variants of sensors .....	5
4. Dimensional drawing .....	5
5. Installation and putting into operation .....	6
6. Mechanical mounting .....	7
7. Electrical connection .....	7
8. Setting the measuring range with a magnetic pen .....	9
9. Function and status indication .....	9
10. Connection examples .....	10
11. User-adjustable measuring ranges .....	12
12. Examples of markings for a variant with user settings .....	12
13. Order code .....	13
14. Correct specification examples .....	14
15. Accessories .....	14
16. Safety, protections and compatibility .....	14
17. Use, manipulation and maintenance .....	15
18. General conditions and warranty .....	15
19. Marking of labels .....	15
20. Technical specifications .....	16
21. Packaging, shipping and storage .....	17

## SYMBOLS USED

---

In order to ensure maximum safety of control processes, we have defined the following safety and information instructions. Each instruction is marked with a corresponding pictogram.



### **Caution, warning, danger**

This symbol informs about particularly important instructions for the installation and operation of the device or dangerous situations that may occur during installation and operation. Ignoring these instructions may be the cause of the fault, damage to or destruction of the device or may cause damage to health.



### **Information**

This symbol indicates particularly important device characteristics and recommendations.



### **Note**

This symbol indicates the useful additional information.

## SAFETY

---



**All the operations described in these operating instructions must be made only by trained personnel or by an authorised person. Warranty and post-warranty repairs must be carried out exclusively at the manufacturer. Incorrect sensor use, assembly or configuration may cause accidents in the application (tank overfilling or damage to the system components).**

**The manufacturer is not responsible for the improper use, working losses incurred by either direct or indirect damage and the expenditure incurred during the installation or the use of the sensor.**

## 1. BASIC DESCRIPTION

---

The hydrostatic level meter HLM-35 is a compact measuring device containing a ceramic or stainless steel strain gauge sensor and evaluation electronics in a stainless steel probe. The ceramic sensor is resistant to different against various liquids (water, oil, coolants, water solutions, etc.). The probe is produced in a configuration with a valve or a capillary, which serves to deliver atmospheric pressure to the probe. The front side of the probe is open, which makes the level meter more resistant against adhesion of coarser soiling. The level meter does not include any elements that can be set. LED signal function.

## 2. RANGE OF APPLICATION

---

For continuous level measurement of clean, slightly polluted or turbid water in non-pressurised tanks. Also for various liquids (oil, coolants, etc.) to measure liquids other than H<sub>2</sub>O, it is necessary to correct the output current. From this For this reason, it is advisable to use a sensor variant with the option of user adjustable. With this variant, we can easily make this correction correction. The suitability of using a level gauge for measuring liquids other than H<sub>2</sub>O is recommended consult the manufacturer.

### 3. VARIANTS OF SENSORS

- HLM-35N-CV** **measuring range 1 ... 100 m H<sub>2</sub>O**, arbitrary standard measuring range (can be custom set in 10 cm increments). In case of the variant with an option of settings with a magnetic pen, the range is user-adjustable within the selected measuring range. Current (4 ... 20 mA) or voltage (0 ... 10 V) output. Sensor with ceramic converter membrane. **Pressure equalisation via a valve.**
- HLM-35N-CK** **measuring range 1 ... 100 m H<sub>2</sub>O**, arbitrary standard measuring range (can be custom set in 10 cm increments). In case of the variant with an option of settings with a magnetic pen, the range is user-adjustable within the selected measuring range. Current (4 ... 20 mA) or voltage (0 ... 10 V) output. Sensor with ceramic converter membrane. **Pressure equalisation via a capillary.**
- HLM-35N-SV** **measuring range 1 ... 100 m H<sub>2</sub>O**, arbitrary standard measuring range (can be custom set in 10 cm increments). In case of the variant with an option of settings with a magnetic pen, the range is user-adjustable within the selected measuring range. Current output (4 ... 20 mA). Sensor with stainless steel converter membrane. **Pressure equalisation via a valve.**
- HLM-35N-SK** **measuring range 1 ... 100 m H<sub>2</sub>O**, arbitrary standard measuring range (can be custom set in 10 cm increments). In case of the variant with an option of settings with a magnetic pen, the range is user-adjustable within the selected measuring range. Current output (4 ... 20 mA). Sensor with stainless steel converter membrane. **Pressure equalisation via a capillary.**

### 4. DIMENSIONAL DRAWING

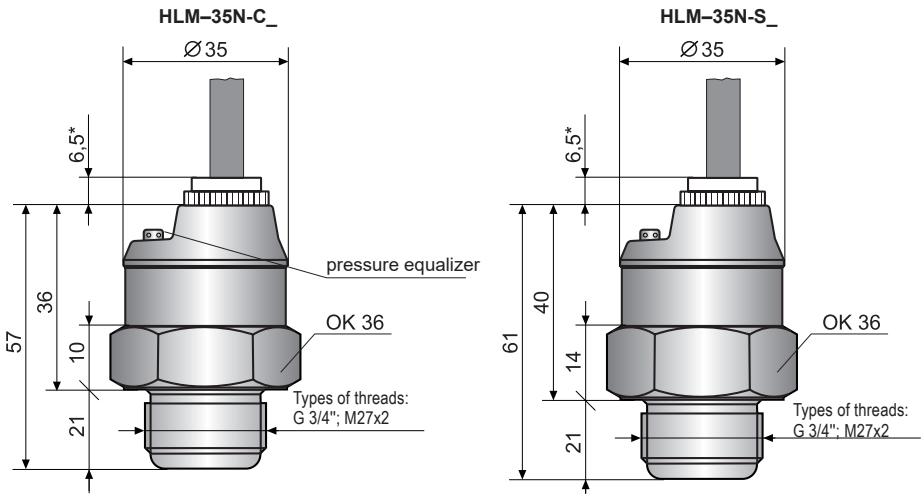

\* According to el. connection type

Variant "A" with short stainless steel terminal

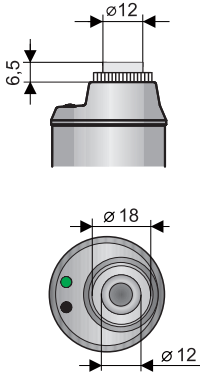

Variant "B" with plastic threaded terminal

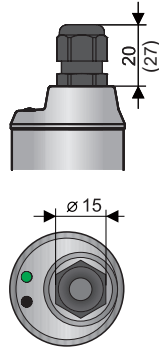

Variant "C" with connector M12

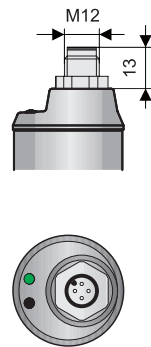

Variant "V" with plastic terminal with spiral relief - in case of increased mechanical strain on the cable.

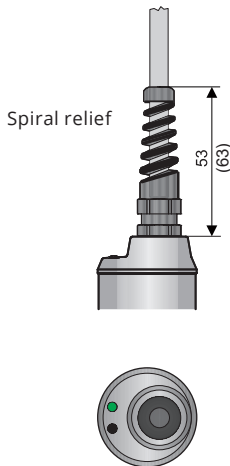

Variant "H" with terminal for protected hoses - for use in outdoor environments or in areas with increased moisture.

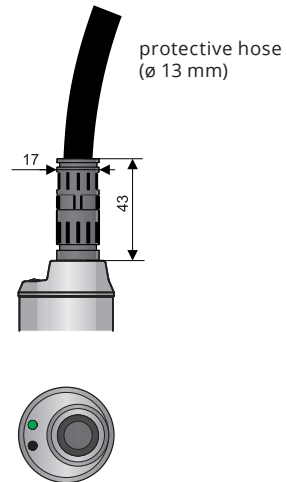

Note. Values in brackets apply for version with the capillary (CK and SK)

## 5. INSTALLATION AND PUTTING INTO OPERATION

This procedure has the following three steps:

- **MECHANICAL MOUNTING - SEE CHAPTER 6**
- **ELECTRICAL CONNECTION - SEE CHAPTER 7**
- **SETTINGS - SEE CHAPTER 8**

## 6. MECHANICAL MOUNTING

- Installation by screwing into the wall of the vessel of the measured area.
- When using the cable containing the equalising capillary, it is necessary to use a non-hermetic connection box for connection to connecting cables.
- For CK and SK type level meter, when winding up excess cable into rolls, a diameter of min. 30 cm must be maintained. We do not recommend shortening or otherwise mechanically adjusting the cable.
- In tanks, where swirling of the liquids occurs as a result of strong inflow or mixing, it is necessary to place the probe in a stilling pipe, behind a partition or at least as far away as possible from the source of the swirling.
- When using it for liquids other than water, it is necessary to make a correction to the output voltage respecting the density of the measured liquid, and if necessary consult the application with the manufacturer.
- For the measurement of liquids other than H<sub>2</sub>O, it is advisable to use a user-adjustable version of the sensor where the output current can be corrected in a simple way.

## 7. ELECTRICAL CONNECTION



Electrical connection can only be made in a voltage-free state!

In the event that the level meter is fitted with a shielded cable, it is necessary to ground the cable on the side of the power source for the event of a possible lightning electrical discharge in the vicinity of the sensor.

In the event that the level meter is installed in an outdoor environment at a distance greater than 20 m from the outdoor switchboard, or from an enclosed building, it is necessary to supplement the electrical cable leading to the level meter with suitable overvoltage protection.

In case of strong ambient electromagnetic interference, paralleling of conductors with power distribution, or for distribution to distances over 30m, we recommend using a shielded cable and its grounding on the side of the power source.

Level meters HLM-35 with a type A, B, V or H cable terminal, are connected to the assessment units permanently by a connection cable, see pg. 2.

Level meters HLM-35 with connection method type C (see pg. 2) are connected to assessing units by means of a connector socket with a press-in cable, or by means of a detachable connector socket without a cable (see accessories), the connector is not part of the sensor. In this case the cable is connected to the inside pins of the socket according to the figure below.

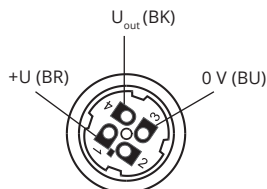

*Inside view of the connector socket (variant "C")*

**In case of use cable with capillary** connect the positive pole (+U) of the power supply to the red wire RD, or connector pin no. 1, the negative pole (0 V) to the blue wire BU, or connector pin no. 3, and the output voltage ( $U_{out}$ ) to the black wire BK, or connector pin no. 4. Connection diagrams are provided in the figures below.

**In case of use cable without capillary** connect the positive pole (+U) of the power supply to the brown wire BR, or connector pin no. 1, the negative pole (0 V) to the blue wire BU, or connector pin no. 3, and the output voltage ( $U_{out}$ ) to the black wire BK, or connector pin no. 4. Connection diagrams are provided in the figures below.

Level meter connection with current output

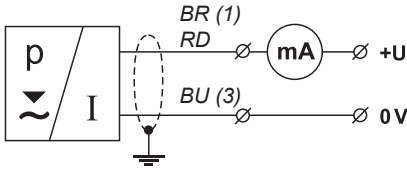

(X) – Connector terminal numbers

**Cable wire colours with a pressed connector:**

- BR – brown
- BU – blue

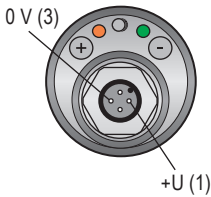

**Cable wire colours with capillary:**

- RD – red
- BU – blue
- – shielding

Level meter connection with current output

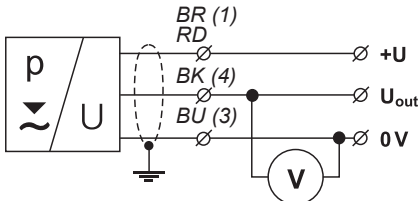

(X) – Connector terminal numbers

**Cable wire colours with a pressed connector:**

- BR – brown
- BK – black
- BU – blue

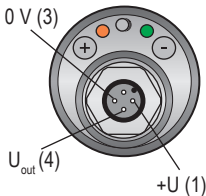

**Cable wire colours with capillary:**

- RD – red
- BU – blue
- BK – black
- – shielding



## 8. NASTAVENÍ MĚŘIČÍHO ROZSAHU POMOCÍ MAGNETICKÉHO PERA (VERZE HLM-35N-\_-\_-\_-M)

The measuring range is set by touching sensitive spots “-” and “+” with the magnetic pen. The sensitive spot “-” is used to enter the setting mode to set the limit of 4 mA (0 V) and reduce the current (voltage) to be set. After reaching the required current (voltage), wait for steady orange LED light and, then, touch the sensitive spot “-” with the magnetic pen to confirm the set value.

The sensitive spot “+” is used to enter the setting mode to set the limit of 20 mA (10 V) and increase the current (voltage) to be set. After reaching the required current (voltage), wait for steady orange LED light and, then, touch the sensitive spot “+” with the magnetic pen to confirm the set value. The setting progress is indicated by the orange “STATE” indicator. The correct level measurement function is indicated by the green “RUN” indicator.

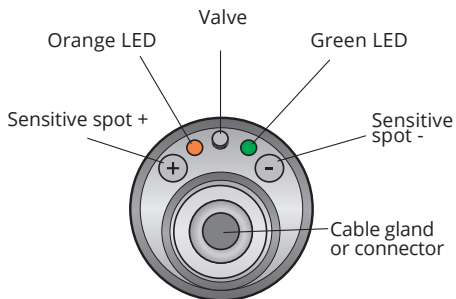

Top view of the level meter

## 9. FUNCTION AND STATUS INDICATION

Indicator	Colour	Function
"RUN"	Green	<p><b><u>Measuring function indication</u></b></p> <p><b>Flashing</b> – (repeats in approx. 0.5 s according to measurement period) – proper level measurement function</p> <p><b>Dark</b> – incorrect installation or malfunction. In addition, the LED indicator is dark in the limit setting mode.</p> <p><b>Alternating flashing of green and orange LEDs</b> – incorrectly set limits</p>
"STATE"	Orange	<p><b><u>Settings indication</u></b></p> <p><b>Slow flashing</b> – 4 mA (0 V) limit setting signalling</p> <p><b>Fast flashing – 20 mA (10 V) limit setting signalling</b></p> <p><b>Permanent shine</b> – the level meter is ready to confirm the limit setting using the magnetic pen</p> <p><b>3 short flashes</b> – confirmation of the settings</p> <p><b>The simultaneous shine of green and orange LEDs</b> – when touching the magnetic pen to confirm the limit setting</p>

## 10. CONNECTION EXAMPLES

### CONNECTION OF LEVEL METER HLM-35-C-I WITH CURRENT OUTPUT TO THE UNIT PDU-4xx-P (OUTPUT 4 ... 20 mA) USING JUNCTION BOX NB

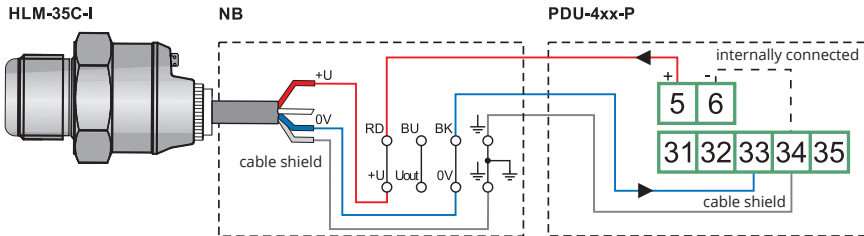

In the case using a connection box with integrated overvoltage protection, the sensor needs to be connected to the bottom series of terminals. This series of contacts is marked by label SENSOR.

### CONNECTION OF LEVEL METER HLM-35-C-U WITH VOLTAGE OUTPUT TO THE UNIT PDU-4xx-P (OUTPUT 0 ... 10 V) USING JUNCTION BOX NB

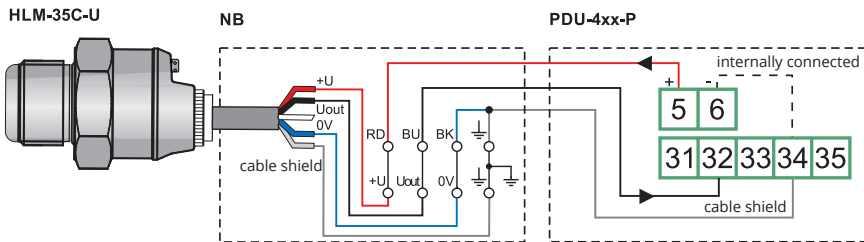

In the case using a connection box with integrated overvoltage protection, the sensor needs to be connected to the bottom series of terminals. This series of contacts is marked by label SENSOR.

### CONNECTION OF LEVEL METER HLM-35-C-I WITH CURRENT OUTPUT TO THE UNIT PDU-4xx-W (OUTPUT 4 ... 20 mA) USING JUNCTION BOX NB

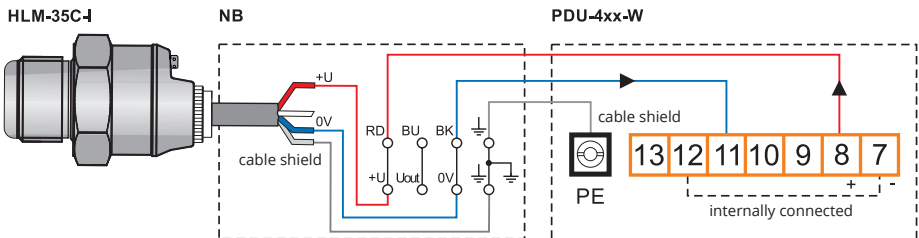

In the case using a connection box with integrated overvoltage protection, the sensor needs to be connected to the bottom series of terminals. This series of contacts is marked by label SENSOR.

**CONNECTION OF LEVEL METER HLM-35-C-U WITH VOLTAGE OUTPUT TO THE UNIT PDU-4xx-W (OUTPUT 0 ... 10 V) USING JUNCTION BOX NB**

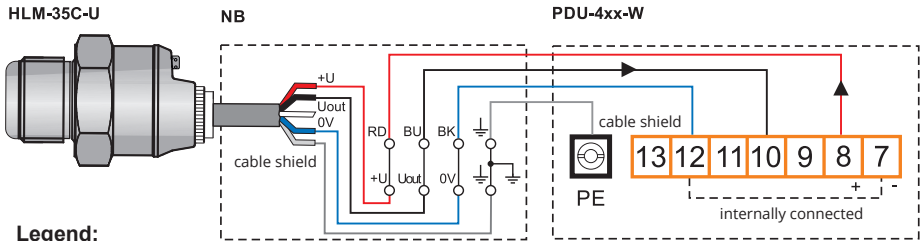

**Legend:**

- BR - brown (capillary-free cable)
- RD – red (cable with capillary)
- BU – blue
- BK – black
- (ground symbol) – cable shield

In the case using a connection box with integrated overvoltage protection, the sensor needs to be connected to the bottom series of terminals. This series of contacts is marked by label SENSOR.

**CONNECTION OF LEVEL METER HLM-35 WITH CURRENT OUTPUT TO THE PCU-100**

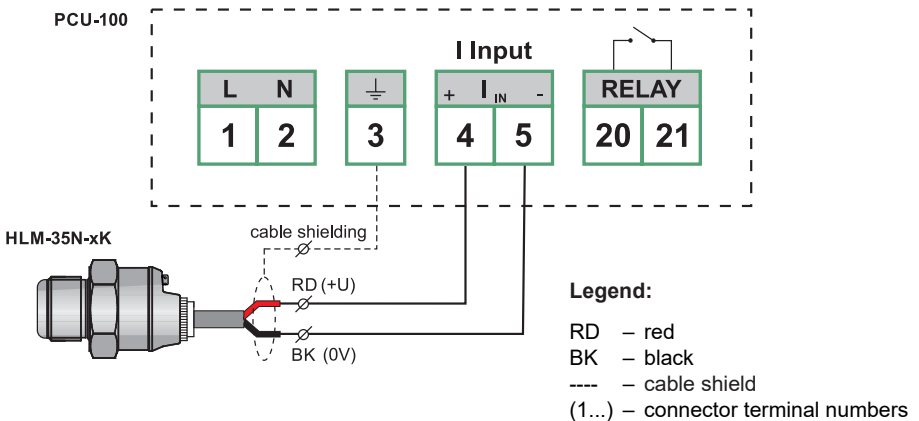

**Legend:**

- RD – red
- BK – black
- – cable shield
- (1...) – connector terminal numbers

Here is the connection of the PCU-100 -\_- I unit with the HLM-35N -\_- I level meter.

## 11. USER-ADJUSTABLE MEASURING RANGES

For the variants of sensors with the possibility of user settings, it is possible to choose from the ranges shown in the following table.

USER-ADJUSTABLE MEASURING RANGES FOR THE M VARIANT					
stainless steel membrane of the sensor			ceramic membrane of the sensor		
measuring range [m]	code marking	Adjustable range of the water column [m]	measuring range [m]	code marking	Adjustable range of the water column [m]
0 ... 1,0	0010	1,0	0 ... 5,0	0050	5,0
0 ... 3,5	0035	1,0 - 3,5	0 ... 10	0100	5,0 - 10
0 ... 7,0	0070	3,5 - 7,0	0 ... 20	0200	10 - 20
0 ... 10	0100	7,0 - 10	0 ... 50	0500	20 - 50
0 ... 25	0250	10 - 25	0 ... 100	1000	50 - 100
0 ... 40	0400	25 - 40	-	-	-
0 ... 60	0600	40 - 60	-	-	-
0 ... 100	1000	60 - 100	-	-	-

The above table defines the setting variances for each range for both stainless steel and ceramic transducers. The level meters with a broad range are not recommended to be used to measure low levels. Such usage of the sensor brings a more significant measurement error into the measuring system.

## 12. EXAMPLES OF MARKINGS FOR A VARIANT WITH USER SETTINGS

### HLM-35N-CV-G3/4-I-A-M-0100 kabel 3m

(N) non-explosive areas; (CV) ceramic membrane of the sensor, pressure compensation via semi-permeable valve; (G3/4) pipe thread G ¾; (I) current (4 ... 20 mA); (A) stainless steel cable gland for CV and SV; (M) Settings using the magnetic pen, (0100) measuring range 10, the maximum output current can be set in the range of 5 to 10 m see table User-adjustable measuring ranges.

### HLM-35N-SK-M27-I-B-M-0070 kabel 10m

(N) non-explosive areas; (SK) stainless steel membrane of the sensor, pressure compensation by capillary; (M27) metric thread M 27x2; (I) current (4 ... 20 mA); (B) plastic threaded cable gland, for CV, CK, SV and SK; (M) Settings using the magnetic pen, (0070) measuring range 7 m, the maximum output current can be set in the range of 3,5 to 7 m, see table User-adjustable measuring ranges.

# 13. ORDER CODE

<b>PRODUCT</b>	
HLM-35	
<b>PERFORMANCE</b>	
N	non-explosive areas
<b>TYPE OF MEMBRANE</b>	
CV	ceramic membrane of the sensor, pressure compensation via semi-permeable valve
CK	ceramic membrane of the sensor, pressure compensation by capillary
SV	stainless steel membrane of the sensor, pressure compensation via a semi-permeable valve
SK	stainless steel membrane of the sensor, pressure compensation by capillary
<b>PROCESS CONNECTION</b>	
G	pipe thread G 3/4
M27	metric thread M 27x2
<b>TYPE OF OUTPUT</b>	
I	current (4 ... 20 mA)
U	voltage (0 ... 10 V), not available for membrane type SV, SK
<b>CONNECTION METHOD</b>	
A	stainless steel cable gland for CV and SV
B	plastic threaded cable gland, for CV, CK, SV and SK
C	connector (socket not included with sensor, recommended type - see accessories.) for CV and SV
V	plastic cable gland with spiral relief for CV, CK,SV and SK
H	plastic cable gland for protective hose for CV and SV
<b>SET-UP ELEMENTS</b>	
M	Settings using the magnetic pen
L	Without set-up elements; this cannot be used with the SV and SK type diaphragm
<b>MEASURING RANGE</b>	
0010 ... 1000	1 ... 100 m w (see the table above)
<b>CABLE</b>	
K	cable length in m
<b>EXAMPLE OF CODING</b>	
HLM-35 N - CV - M27 - I - A - M - 0035 K 2	

<sup>1)</sup> factory setting to the required range, according to the order code (measuring range).

## 14. CORRECT SPECIFICATION EXAMPLES

---

### HLM-35N-CV-G3/4-I-A-M-0010 K 3

(N) provedení do normálních prostor; (CV) keramická membrána měniče s vyrovnávačem tlaku; (G $\frac{3}{4}$ ) procesní připojení závitem G $\frac{3}{4}$ “; (I) proudový výstup 4...20 mA; (A) nerezová vývodka; (M) nastavení pomocí magnetického pera; rozsah 1 m; kabel 3 m.

### HLM-35N-CK-M27-U-A-L-0500 K 52

(N) provedení do normálních prostor; (CK) keramická membrána měniče s kapilárou; (M27) procesní připojení závitem M27; (U) napěťový výstup 0...10 V; (A) nerezová vývodka; (L) bez nastavovacích prvků; rozsah 50 m; kabel 52 m.

## 15. ACCESSORIES

---

**optional** – for a surcharge (see catalogue sheet of accessories)

- cable (over the standard length 2 m)
- connector socket (type ELWIKa or ELKA)
- non-hermetic connection box NB
- standard steel or stainless steel welding flange
- protective hose (for type of cable outlet H)
- stainless steel fixing nut
- various types of seals (PTFE, Al, etc.)

## 16. SAFETY, PROTECTIONS AND COMPATIBILITY

---

Level meter HLM-35 is equipped with protection against voltage polarity reversal, protection against current overload and protection against short term overvoltage.

Protection against dangerous contact is provided by low safety voltage according to 33 2000-4-41.

Electromagnetic compatibility is provided by conformity with standards EN 55011/B, EN 61326-1, EN 61000-4-2, -4-3, -4-4, -4-5 and -4-6.

## 17. USE, MANIPULATION AND MAINTENANCE

The level meter does not require any operation for operation. The maintenance of the device consists in checking the integrity of the sensor and the supply cable.



It is forbidden to make any changes or interventions on the HLM-35 level meter without the consent of the manufacturer. Any repairs must only be carried out by the manufacturer or a service organization authorized by him.

The assembly, installation, commissioning, operation and maintenance of the HLM-35 level meter must be carried out in accordance with these instructions and the provisions of the applicable standards for the installation of electrical equipment must be observed.

## 18. GENERAL CONDITIONS AND WARRANTY

Dinel, s.r.o. guarantees for the period of three (3) years that the product has the characteristics as mentioned in the technical specification.

Dinel, s.r.o. is liable for defects ascertained within the warranty period and were claimed in writing. This guarantee does not cover the damages resulting from misuse, improper installation or incorrect maintenance.

This guarantee ceases when the user or the other person makes any changes on the product or the product is mechanically or chemically damaged, or the serial number is not readable.

The warranty certificate must be presented to exercise a claim.

In the case of a rightful complaint, we will replace the product or its defective part. In both cases, the warranty period is extended by the period of repair.

## 19. MARKING OF LABELS

Labels for device of the type **HLM-35** \_ \_ \_ \_ -I- \_ \_ \_ \_ :

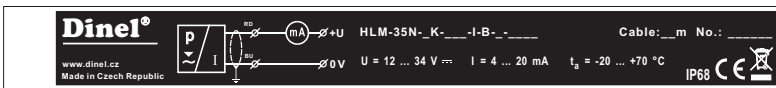

- Symbol of producer: logo Dinel®
- Internet address: www.dinel.cz
- Country of origin: Made in Czech Republic
- Connection diagram and wire designation: + U, 0 V
- Level meter type: HLM-35 \_ \_ \_ \_ -I- \_ \_ \_ \_
- Length of cable: \_ m
- Serial number: Ser. No.: \_\_\_\_\_ – (from the left: production year, serial production number)
- Supply voltage:  $U = 12 \dots 34 \text{ V} \sim$
- Output current range:  $I = 4 \dots 20 \text{ mA}$
- Ambient temperature range:  $t_a = -20 \dots +70 \text{ °C}$
- Protection class: IP68\_ (see Coverage according to electrical connection)
- Compliance mark: **CE**
- Electro-waste take-back system mark:



Size of labels 112 x 12 mm, the size shown does not correspond to reality.

## 20. TECHNICAL SPECIFICATIONS

TECHNICAL SPECIFICATIONS		
performance		non-explosive areas
Supply voltage	HLM-35 _ _ _ -I- _ _ _ _ HLM-35 _ _ _ -U- _ _ _ _	12 ... 34 V DC 12 ... 34 V DC
Current output	HLM-35 _ _ _ -I- _ _ _ _	4 ... 20 mA
Voltage output	HLM-35 _ _ _ -U- _ _ _ _	0 ... 10 V
Consumption (eg no-load output)	HLM-35 _ _ _ -U- _ _ _ _	max. 8 mA
Permissible overload		1,5x range
Basic accuracy (nonlinearity, hysteresis, repeatability)		0.5% of range (adjustable variant 0.2%)
Long-term stability		0,3% / year
Temperature error for zero and range in the range 0 ... + 50 ° C		max. 0,04% / K
Temperature compensation range		0 ... +50 ° C
Operating temperature range (medium temperature)		-20 ... +70 ° C
Max. load resistance of current output (at U = 24 V DC)		$R_{max} = 600 \Omega$
Min. load resistance of voltage output		$R_{min} = 1 \text{ k}\Omega$
Protection class	typ HLM-35 _ _ _ -C- _ _ _ _ typ HLM-35 _ _ _ -(A,B,V,H)- _ _ _ _	IP67 IP68
Cable	typ HLM-35 _ _ V- _I- _ _ _ _ typ HLM-35 _ _ V- _U- _ _ _ _ typ HLM-35 _ _ K- _I- _ _ _ _ typ HLM-35 _ _ K- _U- _ _ _ _	PVC 2 x 0,75 mm <sup>2</sup> PVC 3 x 0,5 mm <sup>2</sup> PE 2 x 0,25 mm <sup>2</sup> with capillary PE 3 x 0,25 mm <sup>2</sup> with capillary
Weight	sensor cable (1 m)	190 g 60 g

### USED MATERIALS

Sensor part	Variants	Standard material
Housing	All types	stainless steel W.Nr. 1.4404 (AISI 316L)
End of sensor	All types	stainless steel W.Nr. 1.4301 (AISI 304)
Membrane	HLM-35 _CV- _ _ _ _ _ HLM-35 _CK- _ _ _ _ _ HLM-35 _SV- _ _ _ _ _ HLM-35 _SK- _ _ _ _ _	ceramic Al <sub>2</sub> O <sub>3</sub> 96% ceramic Al <sub>2</sub> O <sub>3</sub> 96% stainless steel W.Nr. 1.4404 (AISI 316L) stainless steel W.Nr. 1.4404 (AISI 316L)
Gasket O-rings	All types	FPM (Viton)
Cable terminal	HLM-35 _ _ _ _ -A- _ _ _ _ HLM-35 _ _ _ _ -B- _ _ _ _ HLM-35 _ _ _ _ -V- _ _ _ _ HLM-35 _ _ _ _ -H- _ _ _ _	stainless steel W.Nr. 1.4301 (AISI 304) plastic PA / NBR plastic PA / NBR plastic PA / NBR
Connector M12	HLM-35 _ _ _ -C- _ _ _ _	nickel-plated brass



## PROCESS CONNECTION

type	dimensions	marking
Pipe thread	G 3/4"	G
Metric thread	M27x2	M27

## 21. PACKAGING, SHIPPING AND STORAGE

---

The device HLM-35 is packaged in a polyethylene bag, and the entire consignment is placed into a cardboard box. A suitable filler material is used in the cardboard box to prevent mechanical damage during transport.

Remove the device from the packaging only just before using, thereby protecting it from potential damage.

A forwarding company will be used to ship goods to the customer. Upon prior agreement, ordered goods can be picked up in person at company headquarters. When receiving, please check to see that the consignment is complete and matches the order, or to see if any damage has occurred to the packaging and device during transport. Do not use a device clearly damaged during transport, but rather contact the manufacturer in order to resolve the situation.

If the device is to be further shipped, it must be wrapped in its original packaging and protected against impact and weather conditions.

Store the device in its original packaging in dry areas covered from weather conditions, with humidity of up to 85 % without effects of chemically active substances. The storage temperature range is -20 °C až +70 °C.





# Dinel<sup>®</sup>

industrial electronics

**Dinel, s. r. o.**  
U Tescomy 249  
760 01 Zlín  
Czech Republic

phone: +420 577 002 002  
e-mail: [sale@dinel.cz](mailto:sale@dinel.cz)

[www.dinel.cz](http://www.dinel.cz)

*The manufacturer reserves the right to change the specifications and appearance of the product without prior notice*

*Find the updated version at [www.dinel.cz](http://www.dinel.cz)*

*version: 05/2022*

